



# Marylou

Drawer to The Cot Bed 90x200  
Szuflada do łóżka 90x200

EN

Bellamy  
27 Kościuszki Street  
38-500 Sanok  
www.bellamy.pl  
biuro@bellamy.pl

PL

Bellamy  
Ul. Kościuszki 27  
38-500 Sanok  
www.bellamy.pl  
biuro@bellamy.pl

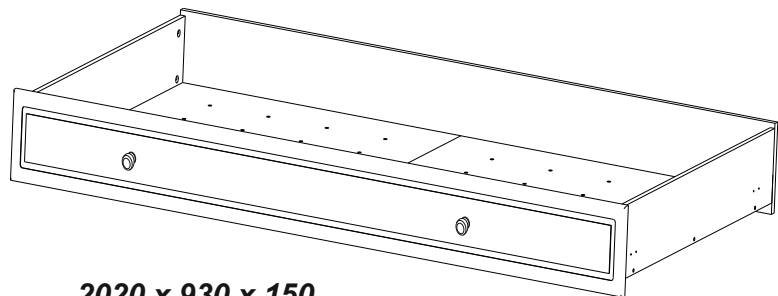

2020 x 930 x 150

EN

## Returns of the assembled furniture will not be accepted.

Before attempting to assembly this product please check the contents of the package. If any components are missing or damaged, please contact the retailer from whom you bought this product.

## Cleaning and maintenance

1. Use generally available furniture cleaning detergents.
2. Do not use aggressive detergents and always read the detergent's usage instructions.
3. Do not use hard brushes or any other harsh materials that could streak the surface of the furniture.

PL

## Zwroty skreconych mebli nie sa przyjmowane.

Przed przystapieniem do montazu nalezy sprawdzic czy nie brakuje zadnych czesci oraz czy nie sa uszkodzone. Jezeli brakuje czesci lub sa uszkodzona, prosze skontaktowac sie z lokalnym dostawca.

## Czyszczenie i pielagnacja

1. Uzywac nalezy ogolnie dostepnych sredkow ochrony mebli drewnianych.
2. Nie stosowac agresywnych sredkow czyszczacych i zawsze zapoznac sie z uwagami producenta tego preparatu.
3. Nie stosowac twardych szczotek czy szorstkich scierek mogacych porysowac powierzchnie mebli.

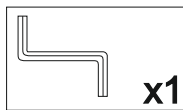

x1

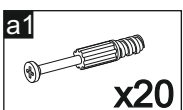

x20



x26

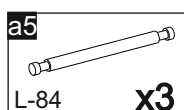

x3

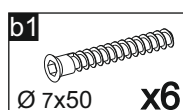

x6

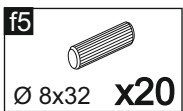

x20

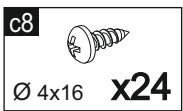

x24

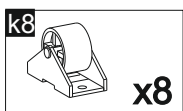

x8

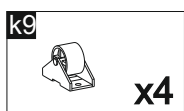

x4

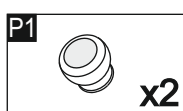

x2

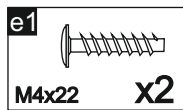

x2

1/4

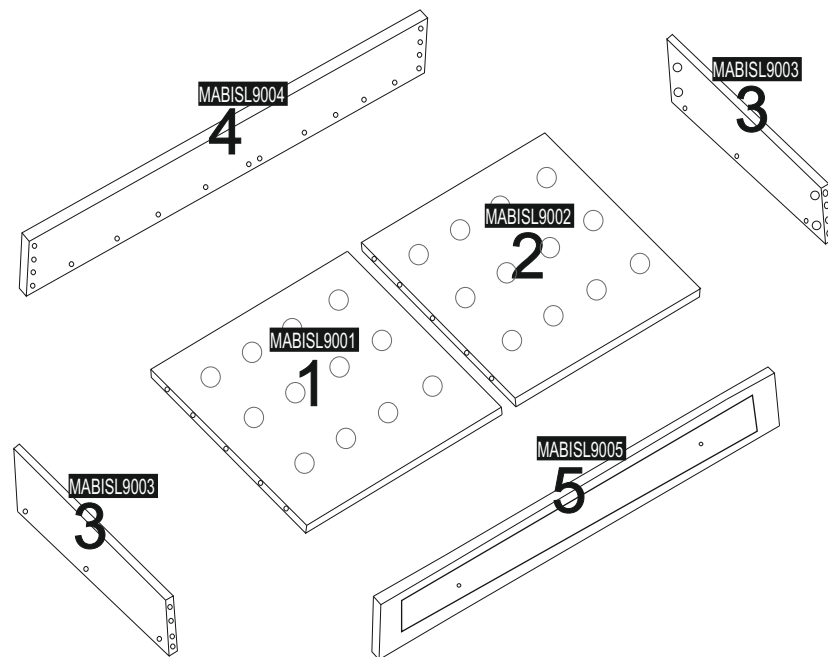
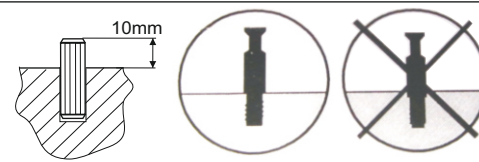
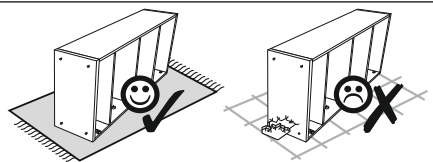

1

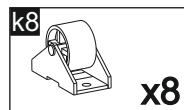

x8

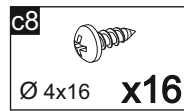

x16

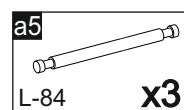

x3

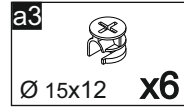
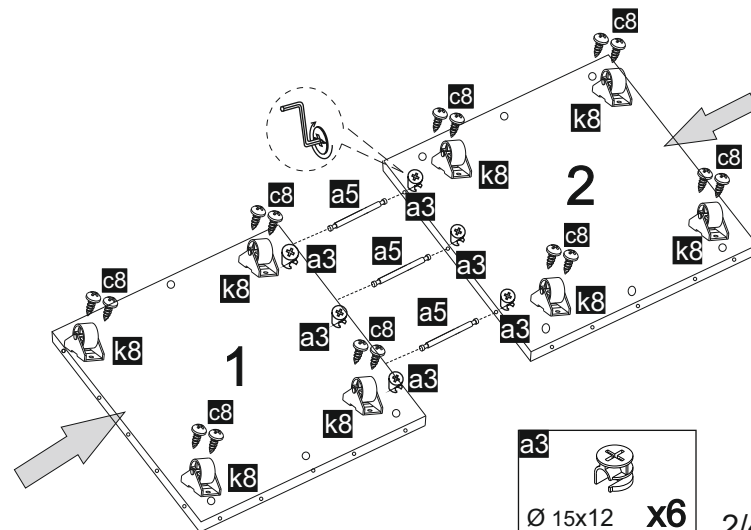

x6

2/4



2

a3  
Ø 15x12 x20

a1  
x20

b1  
Ø 7x50 x 6

f5  
Ø 8x32 x20

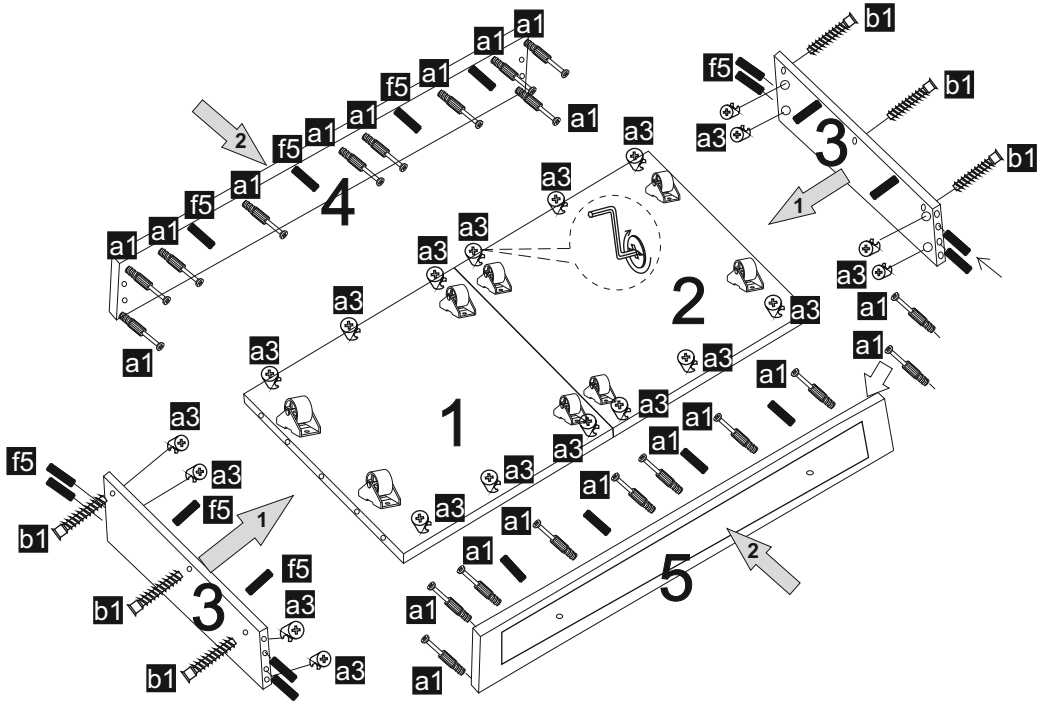

4

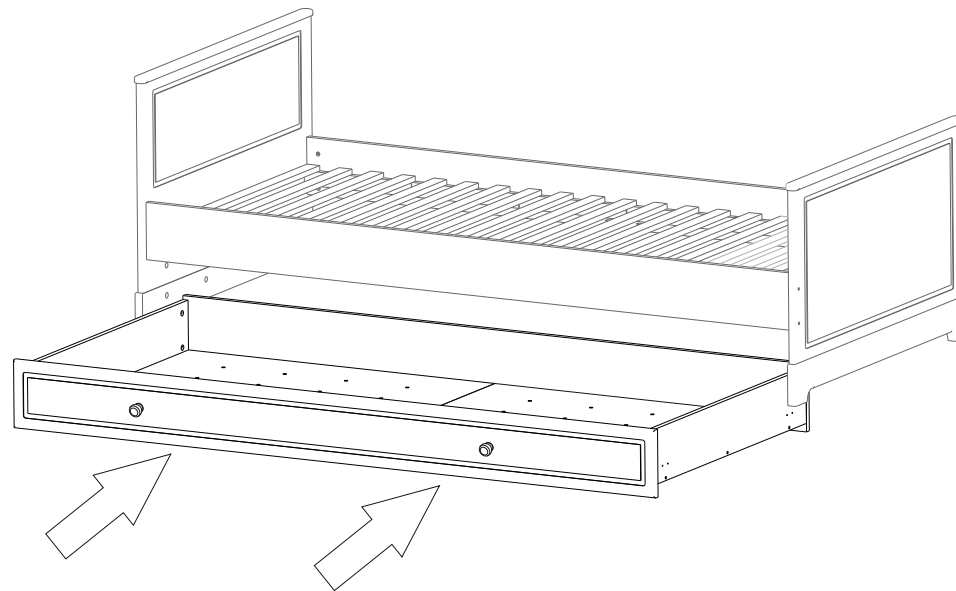

3

k9  
x4

c8  
Ø 4x16 x8

e1  
M4x22 x2

P1  
x2

3/4

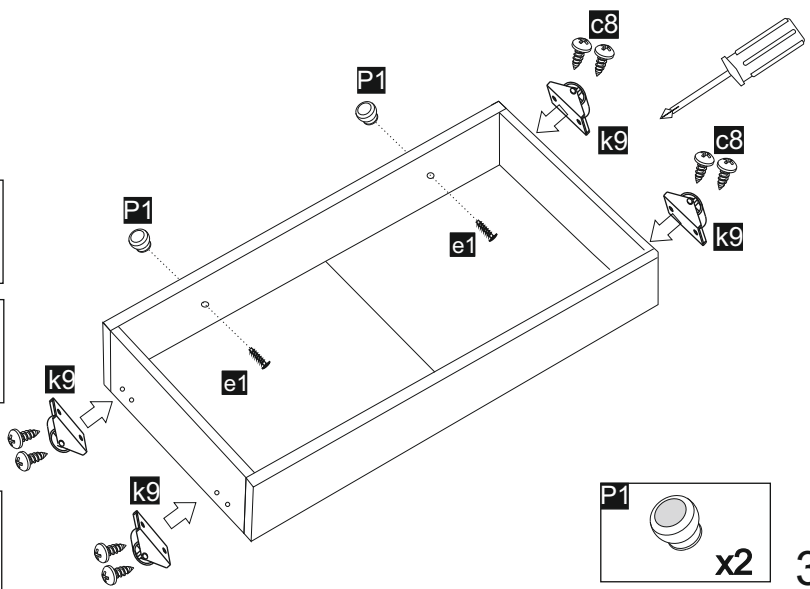

4/4