



Marylou

Drawer to The Cot Bed 60x120
Szufłada do łóżka 60x120

EN

Bellamy
27 Kościuszki Street
38-500 Sanok
www.bellamy.pl
biuro@bellamy.pl

PL

Bellamy
Ul. Kościuszki 27
38-500 Sanok
www.bellamy.pl
biuro@bellamy.pl

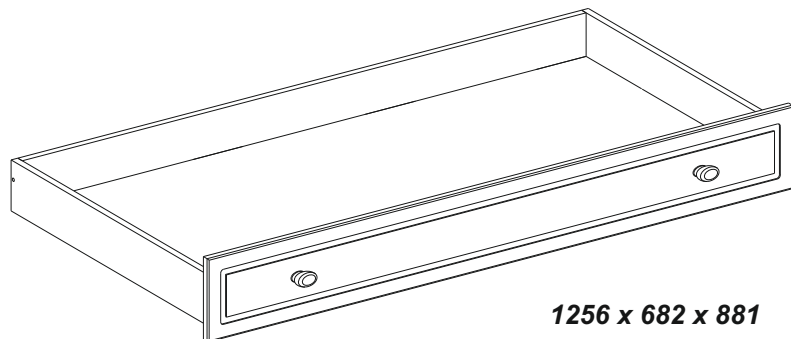

1256 x 682 x 881

EN

Returns of the assembled furniture will not be accepted.

Before attempting to assembly this product please check the contents of the package. If any components are missing or damaged, please contact the retailer from whom you bought this product.

Cleaning and maintenance

1. Use generally available furniture cleaning detergents.
2. Do not use aggressive detergents and always read the detergent's usage instructions.
3. Do not use hard brushes or any other harsh materials that could streak the surface of the furniture.

PL

Zwroty skrzęconych mebli nie są przyjmowane.

Przed przystąpieniem do montażu należy sprawdzić czy nie brakuje żadnych części oraz czy nie są uszkodzone. Jeżeli brakuje części lub są uszkodzona, proszę skontaktować się z lokalnym dostawcą.

Czyszczenie i pielęgnacja

1. Używać należy ogólnie dostępnych środków ochrony mebli drewnianych.
2. Nie stosować agresywnych środków czyszczących i zawsze zapoznać się z uwagami producenta tego preparatu.
3. Nie stosować twardych szczotek czy szorstkich ścierek mogących porysować powierzchnie mebli.

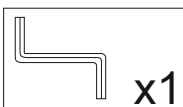

x1

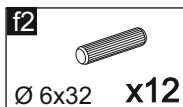

Ø 6x32 x12

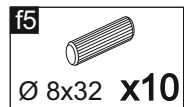

Ø 8x32 x10

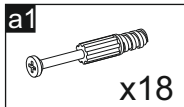

x18

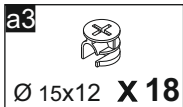

Ø 15x12 x 18

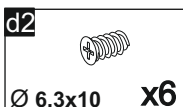

Ø 6,3x10 x6



L-550 x1

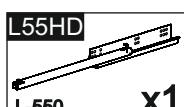

L-550 x1

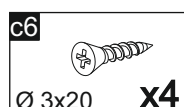

Ø 3x20 x4

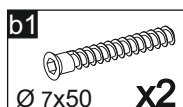

Ø 7x50 x2

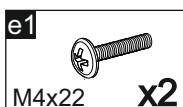

M4x22 x2

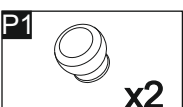

x2

1/8

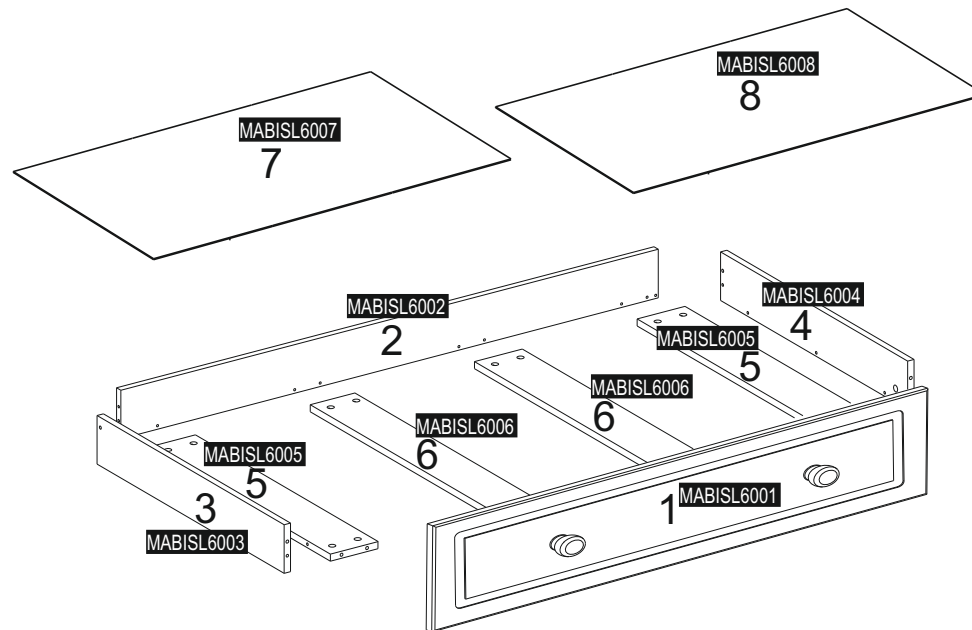
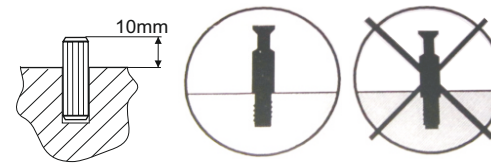
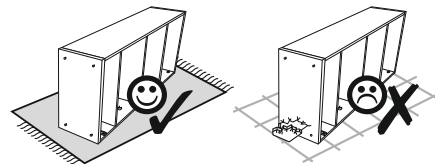

1

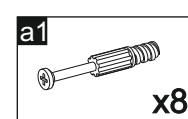
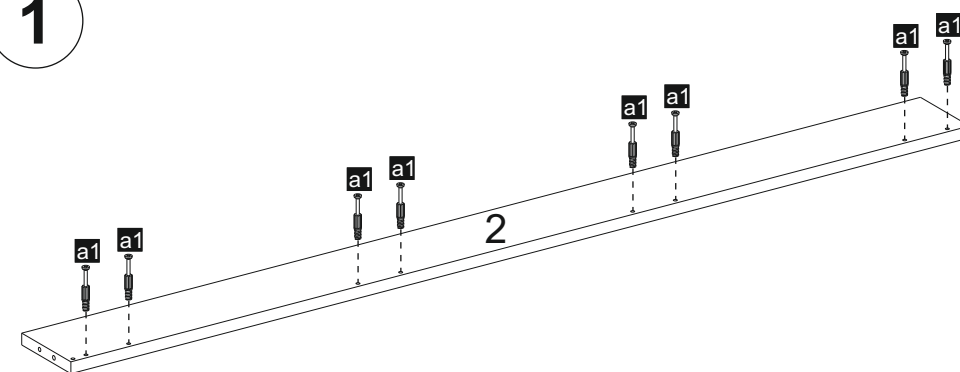

x8

2/8

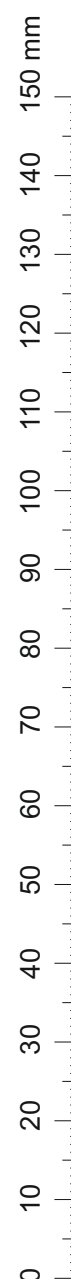

2

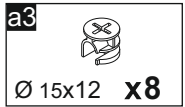
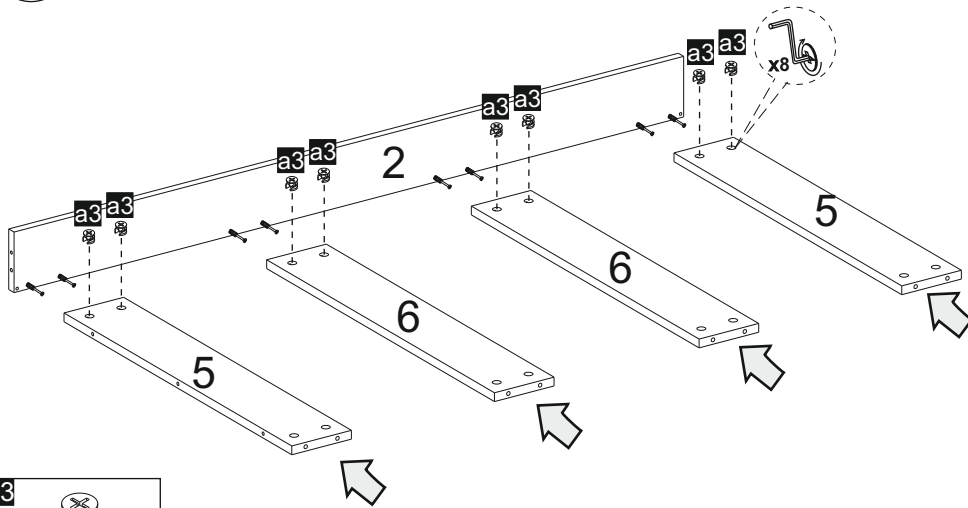

4

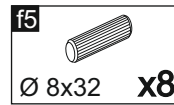
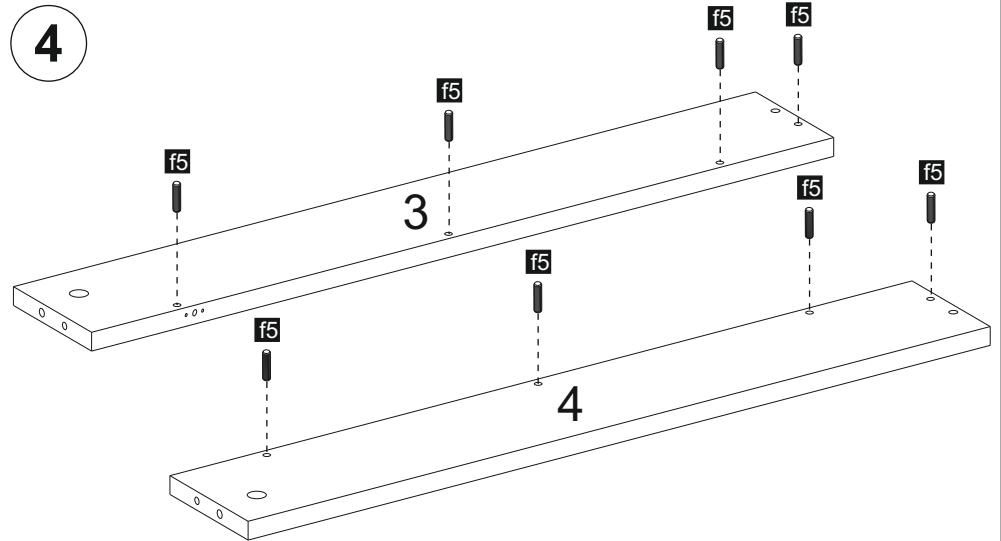

3

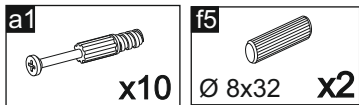
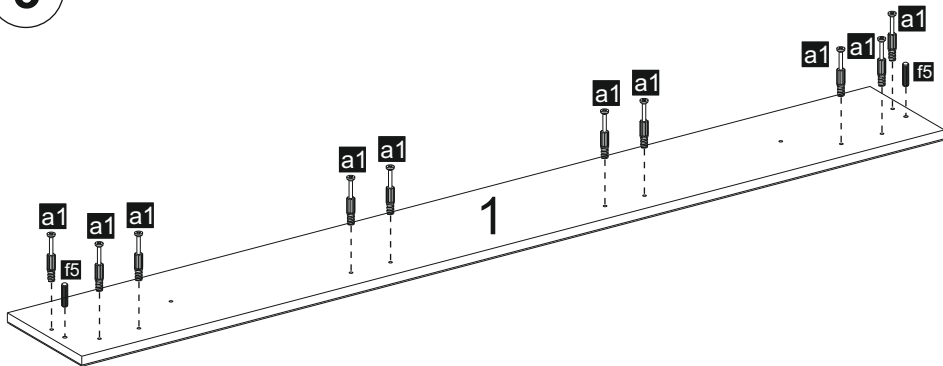

3/8

5

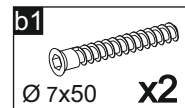
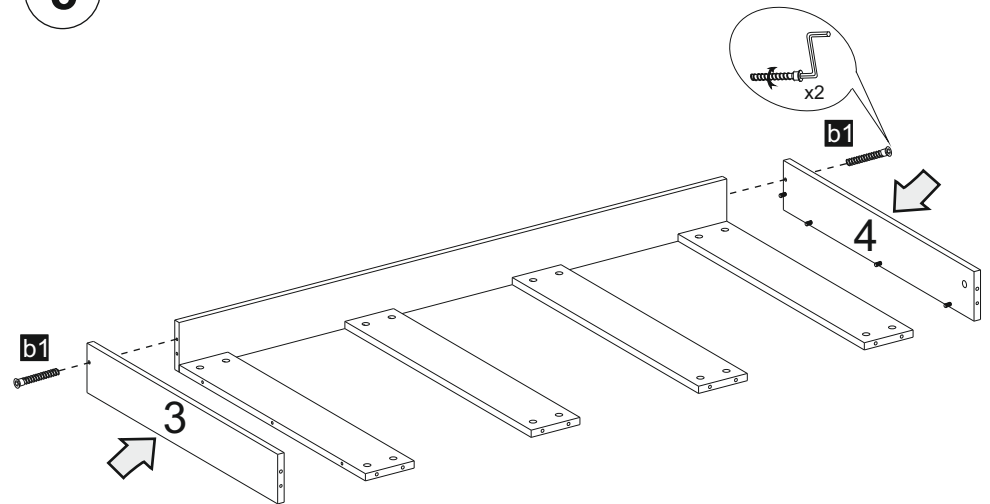

4/8

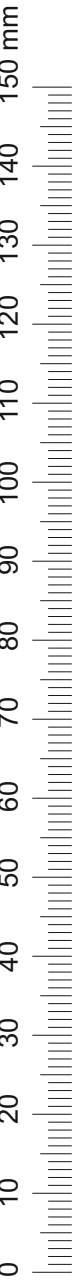

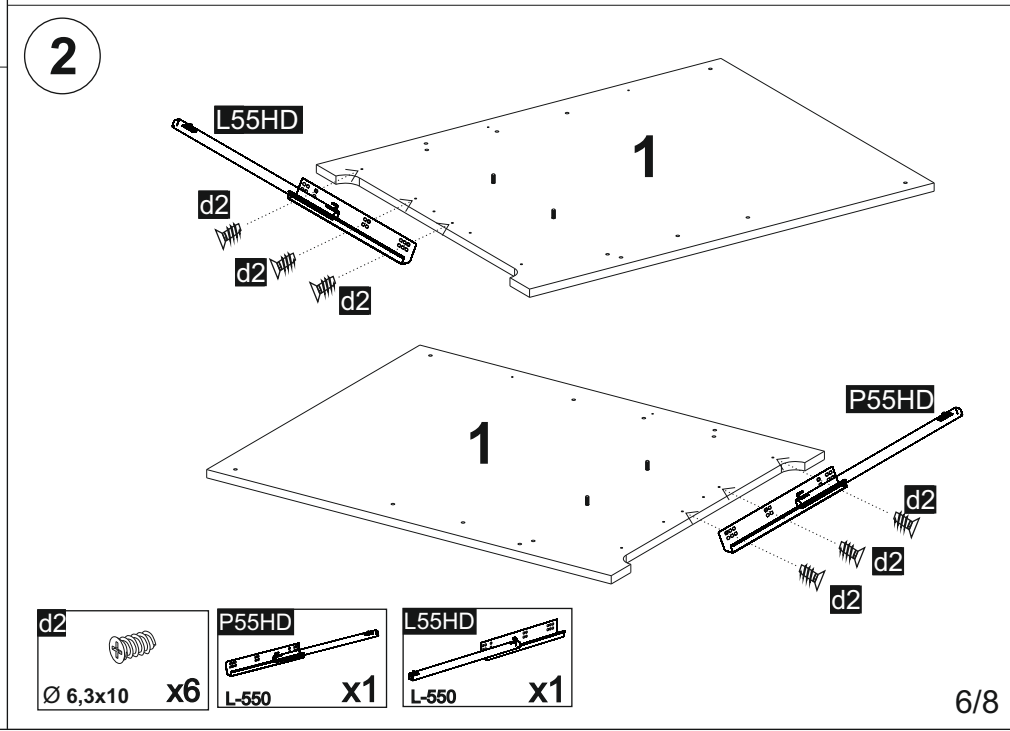
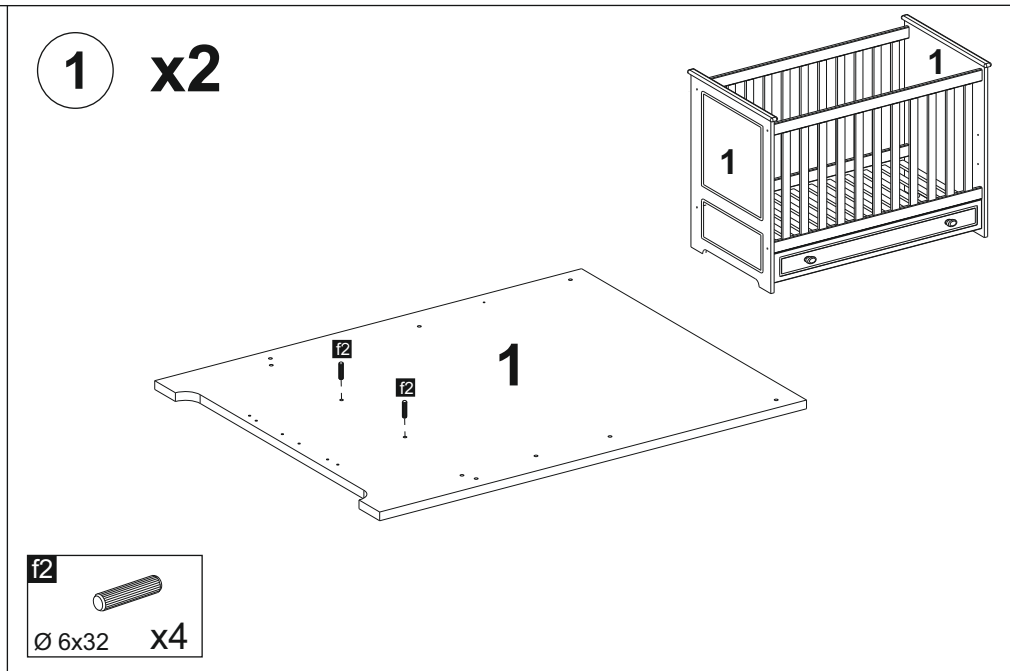
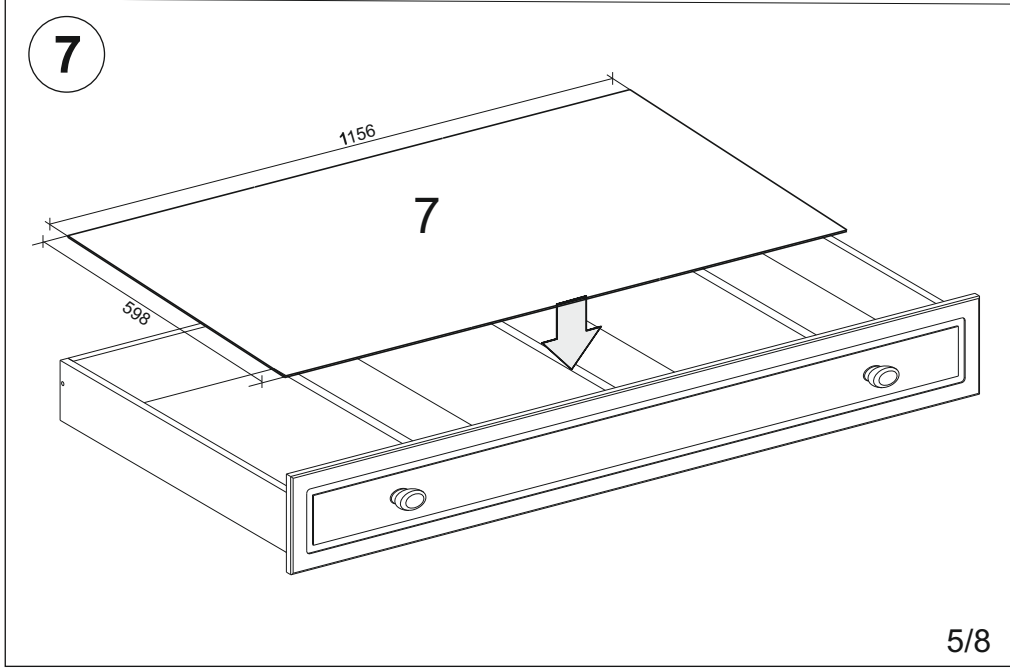
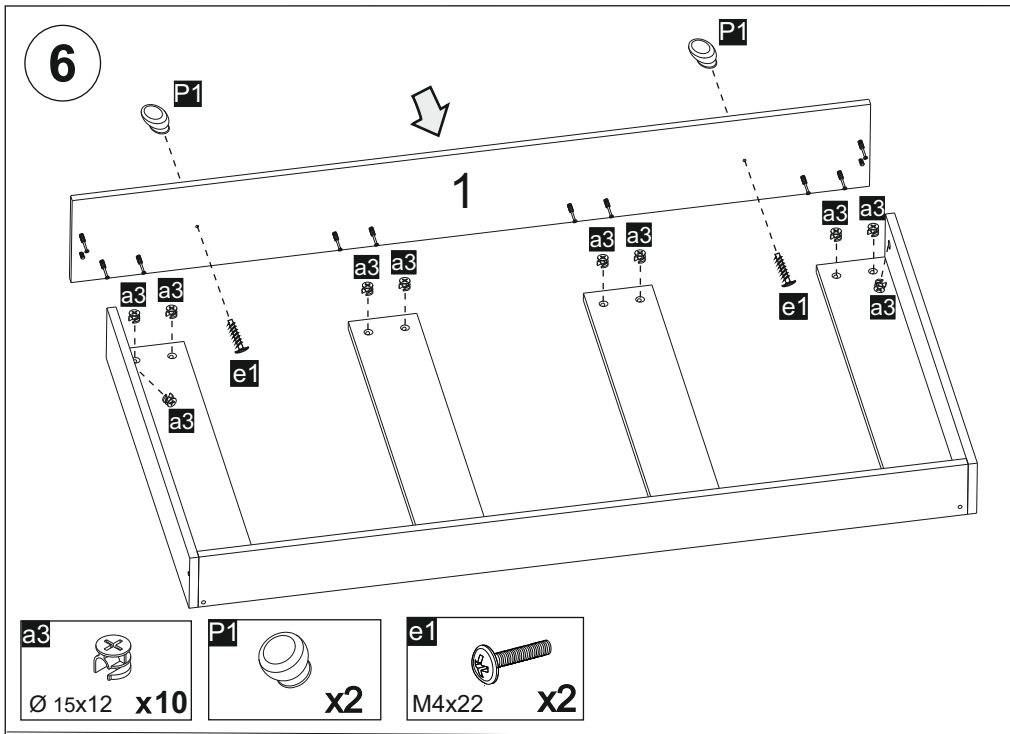

3

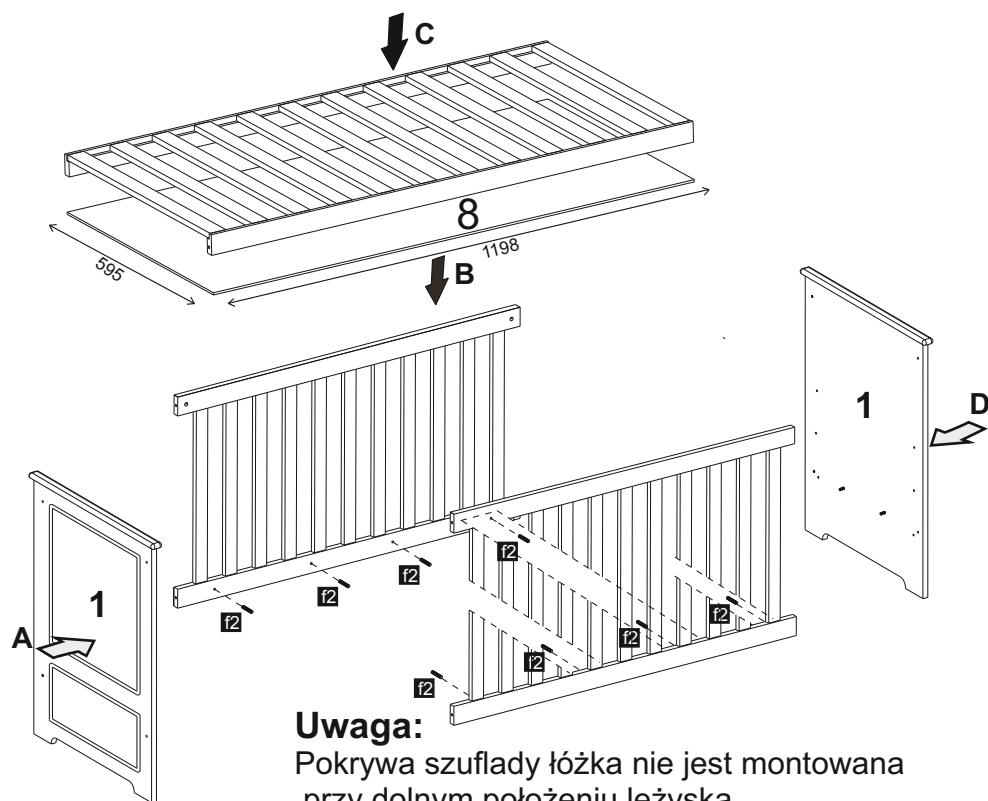
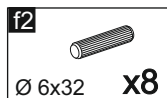
**Uwaga:**

Pokrywa szuflady łóżka nie jest montowana przy dolnym położeniu leżyska. W takim przypadku należy wyciągnąć pokrywę oraz kołki z ramki i przyczółków łóżeczka.

Attention:

The drawer cover cannot be installed when the cot base is on the lowest position. To install the cot base on the lowest position please remove the cover and implied accessories from the sides and front.

7/8

4

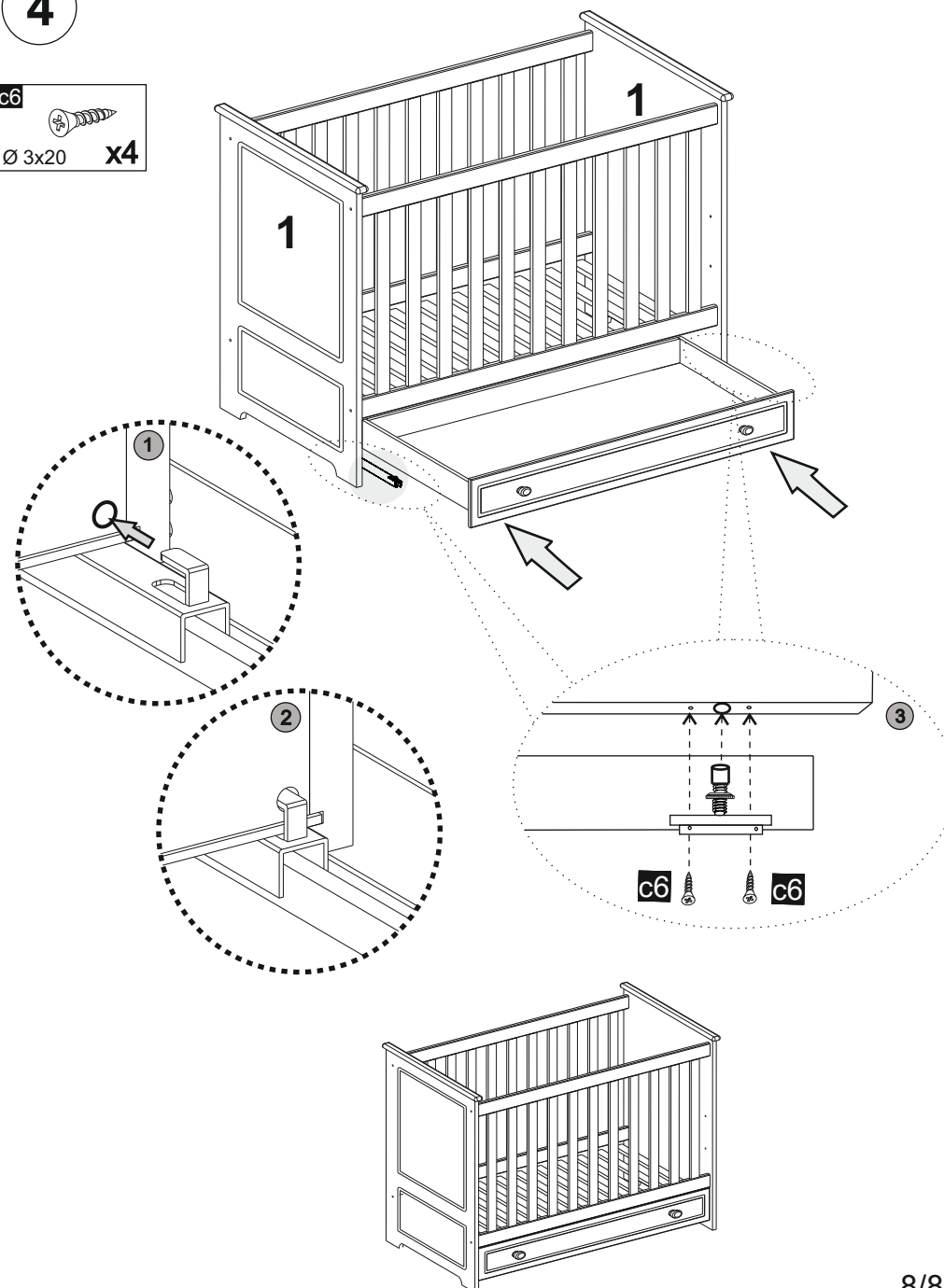
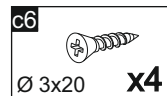

8/8