

<http://www.bega-gruppe.de>

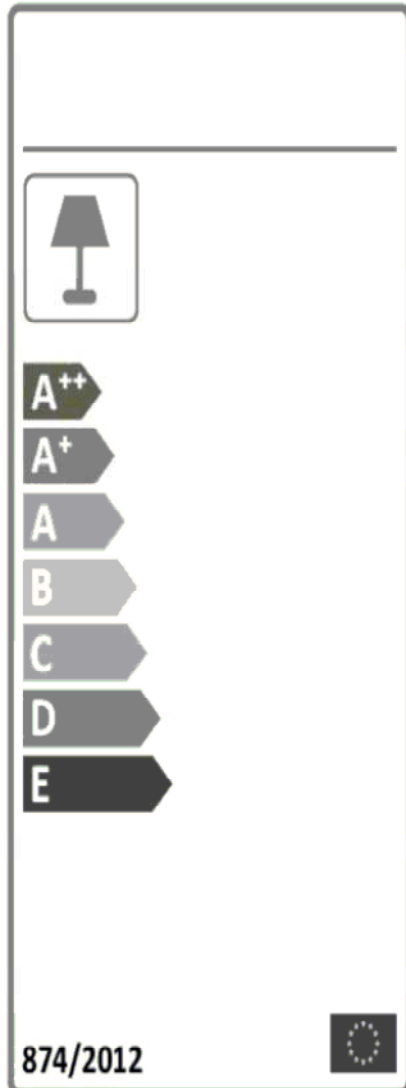

BG	Bulgarisch	български
CS	Tschechisch	čeština
DA	Dänisch	Dansk
DE	Deutsch	Deutsch
ET	Estnisch	Eesti
EL	Griechisch	ελληνικά
EN	Englisch	English
ES	Spanisch	español
FR	Französisch	Français
FI	Finnisch	suomalainen
HR	Kroatisch	hrvatski
HU	Ungarisch	magyar
IT	Italienisch	Italiano
LV	Lettisch	Latvijas
LT	Litauisch	Lietuvos
NL	Niederländisch	Nederlands
PL	Polnisch	Polski
PT	Portugiesisch	português
RO	Rumänisch	român
SK	Slowakisch	slovenský
SL	Slowenisch	slovenščina
SV	Schwedisch	Svenska

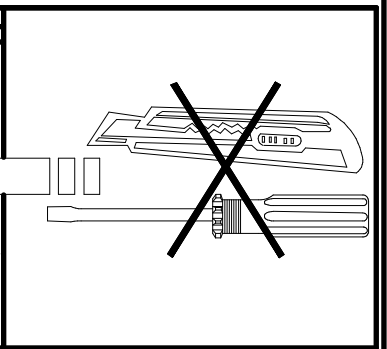

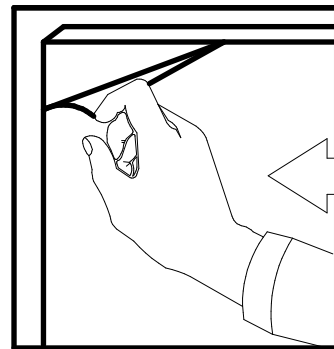
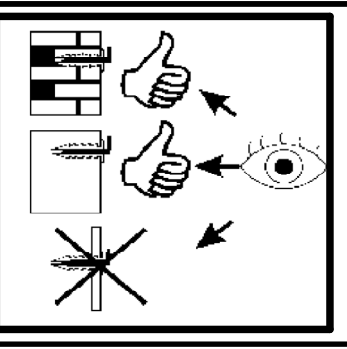
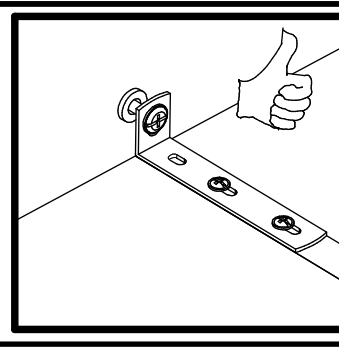
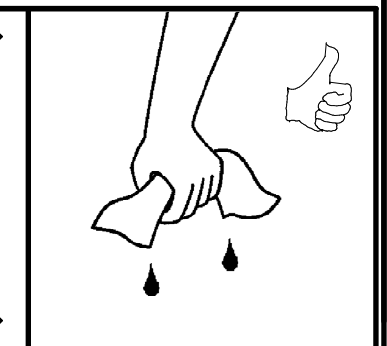
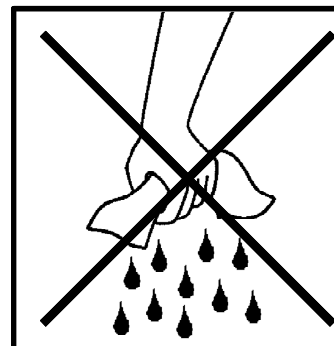
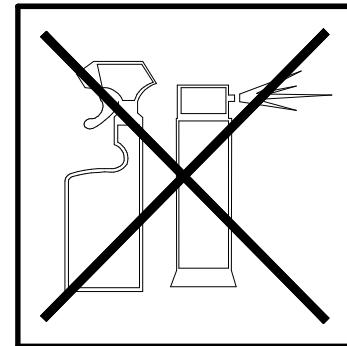
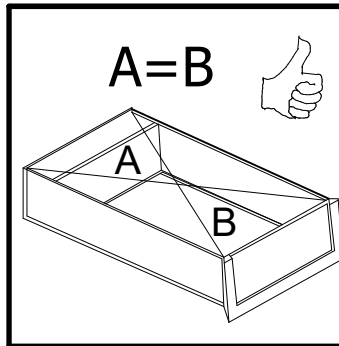
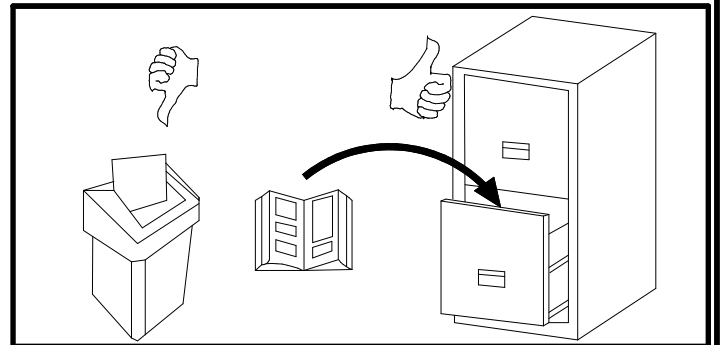
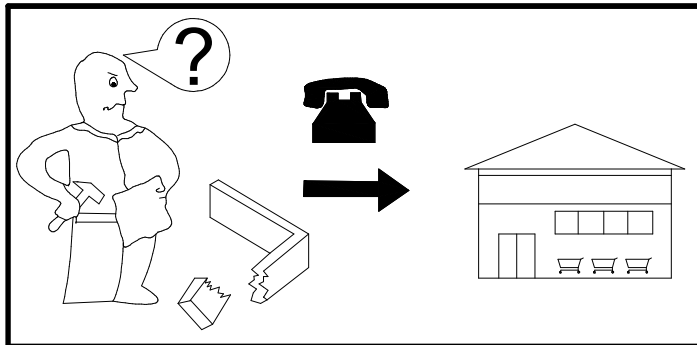
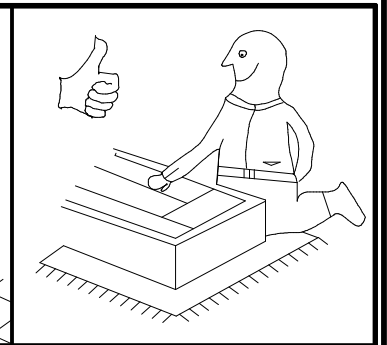
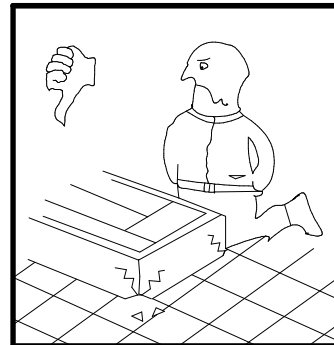
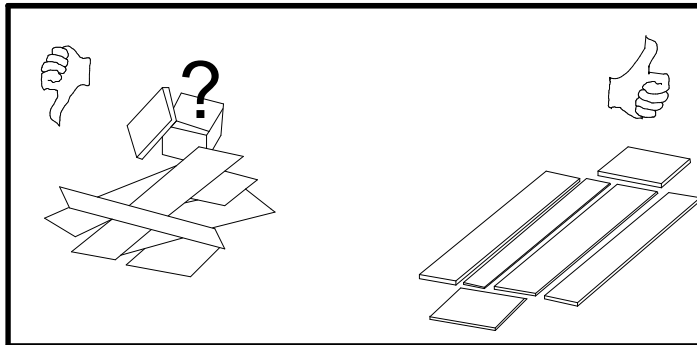
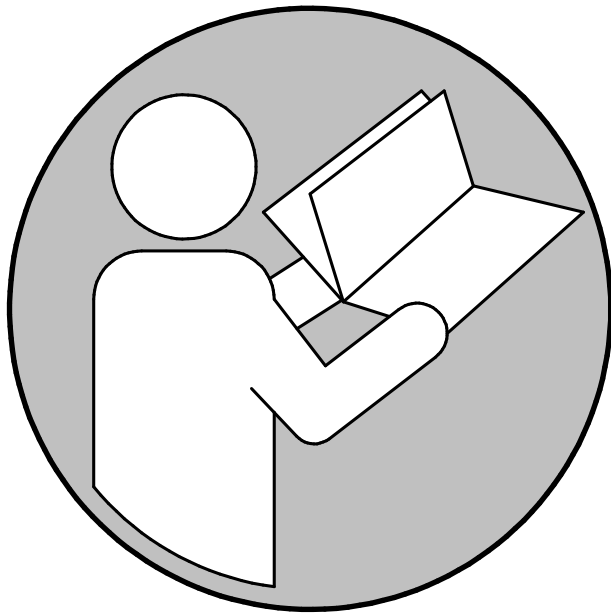

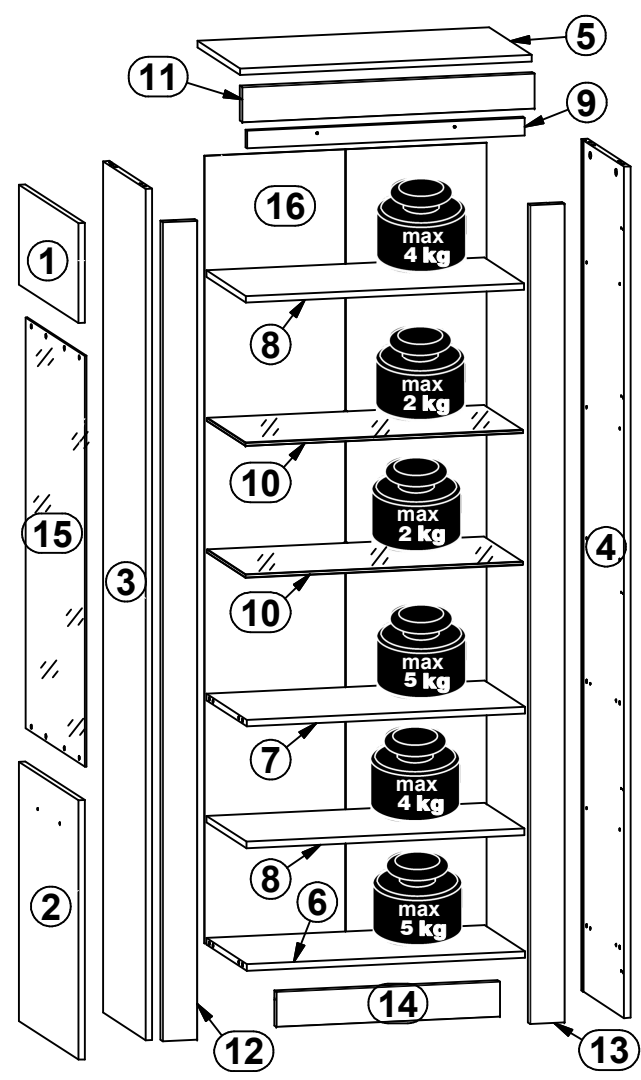
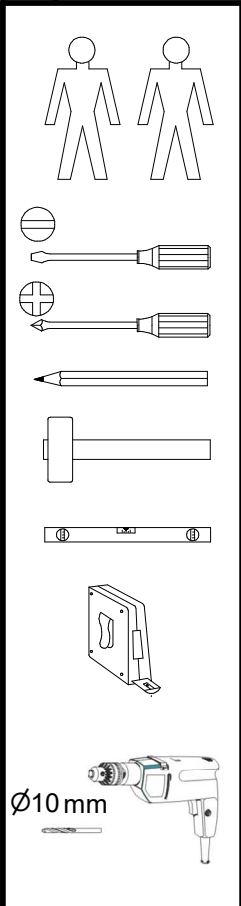

A	B	C (mm)		D
1	S365-0009	516	228	1/2
2	S365-0010	516	592	1/2
3	S365-1014	1944	371	1/2
4	S365-1015	1944	371	1/2
5	S365-2004	679	371	2/2
6	S365-3010	648	351	2/2
7	S365-3011	648	351	2/2
8	S365-3012	647	345	2/2
9	S365-4005	646	40	2/2
10	S365-5015	646	335	2/2
11	S365-5016	680	80	2/2
12	S365-5017	1870	80	1/2
13	S365-5018	1870	80	1/2
14	S365-5019	520	80	2/2
15	S365-5020	938	514	1/2
16	S365-9304	1798	657	1/2

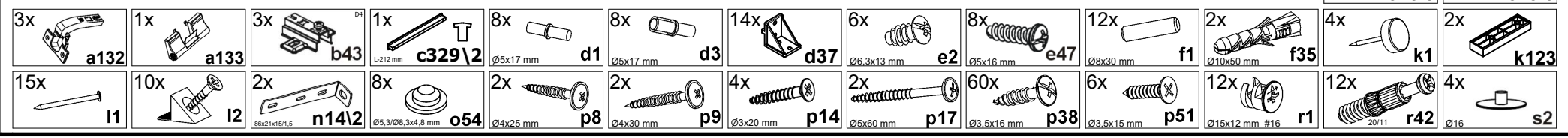
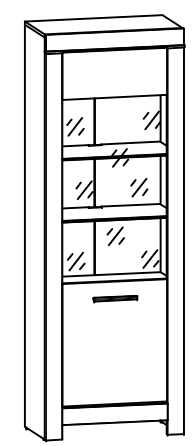

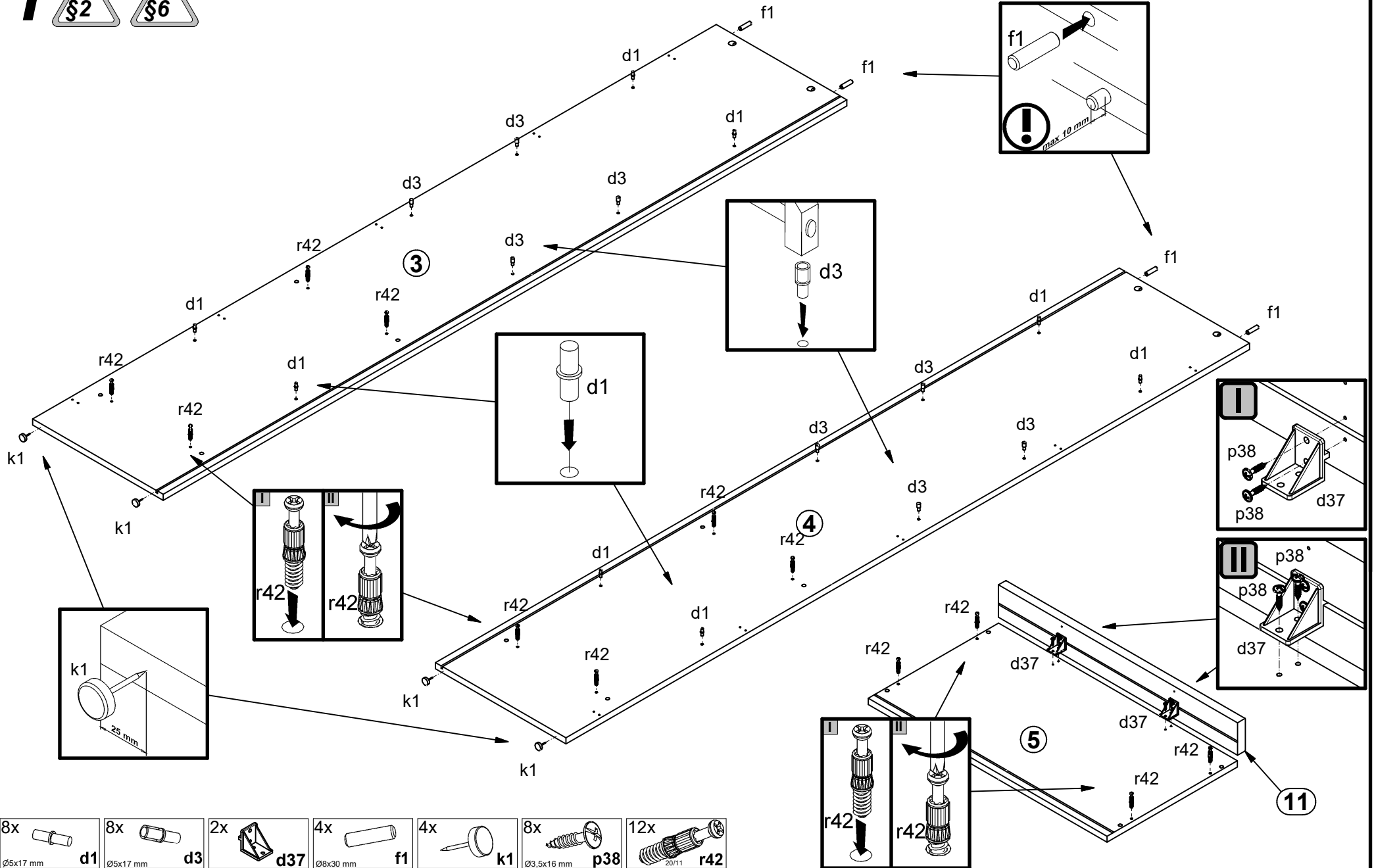





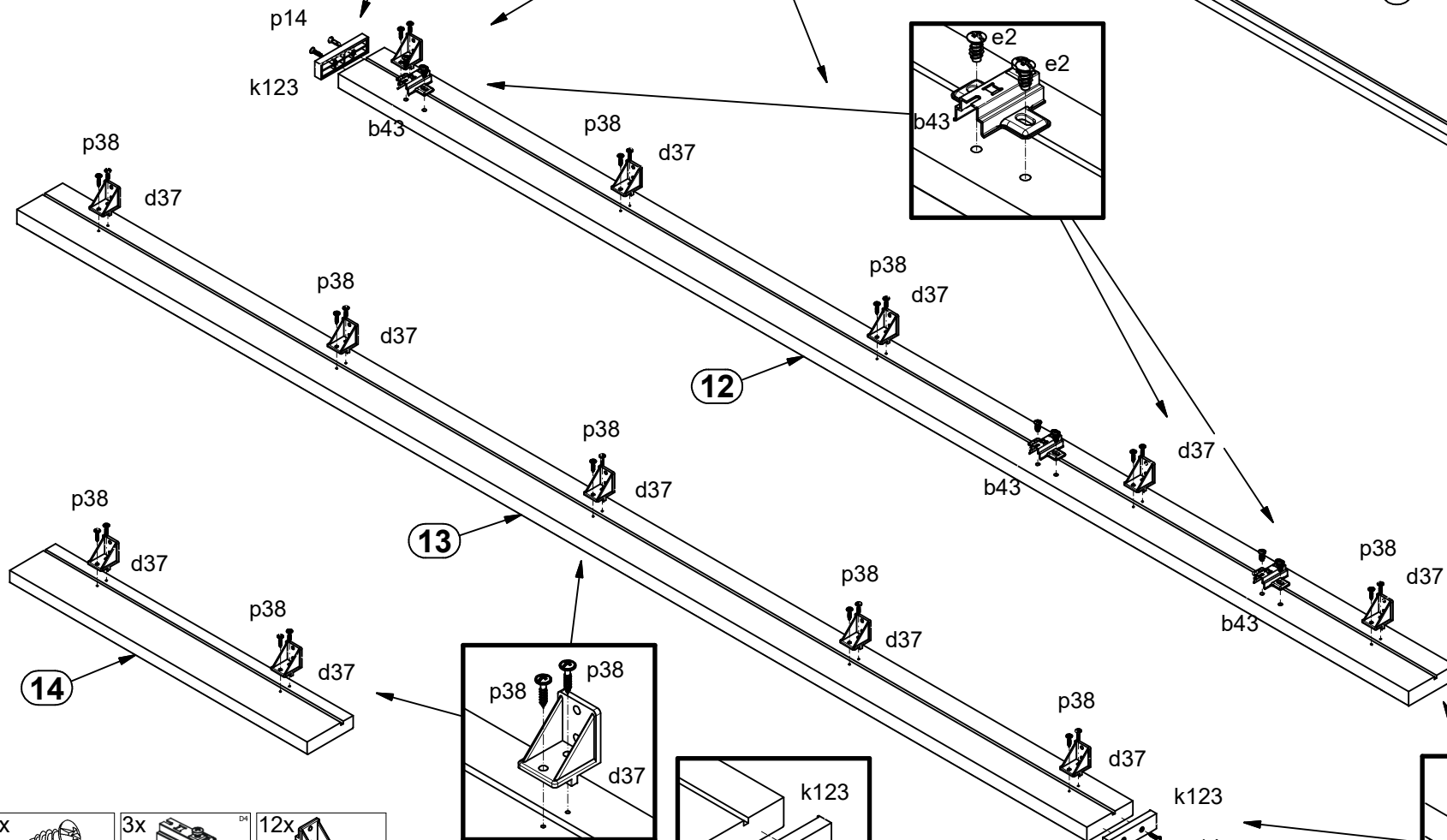
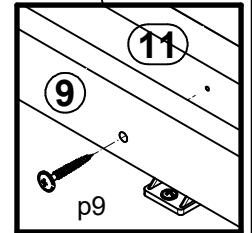
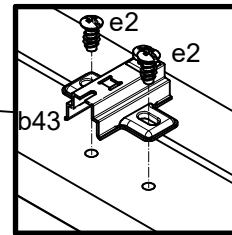
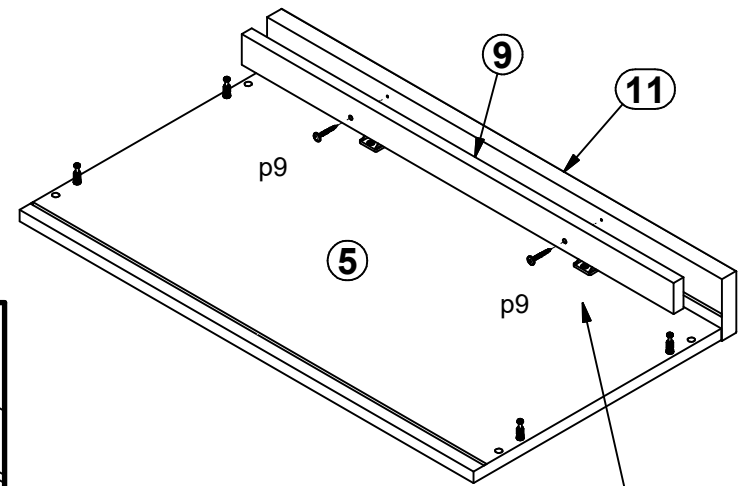
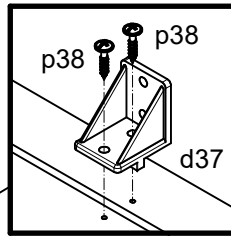
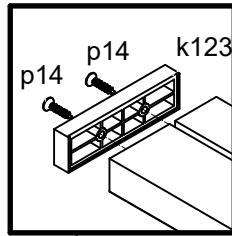

- | | | | | | | |
|----------------------|----------------------|-----------|----------------------|----------|-------------------------|---------------------|
| 8x
∅5x17 mm
d1 | 8x
∅5x17 mm
d3 | 2x
d37 | 4x
∅8x30 mm
f1 | 4x
k1 | 8x
∅3,5x16 mm
p38 | 12x
20/11
r42 |
|----------------------|----------------------|-----------|----------------------|----------|-------------------------|---------------------|

2  



- 6x  e2
Ø6,3x13 mm
- 3x  b43
- 12x  d37
- 2x  p9
Ø4x30 mm
- 4x  p14
Ø3x20 mm
- 24x  p38
Ø3,5x16 mm
- 2x  k123

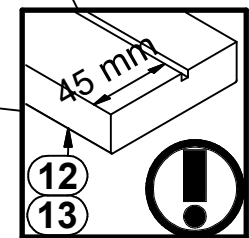
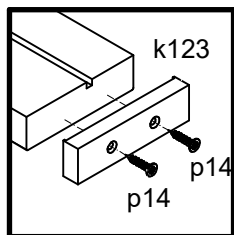



3 

II

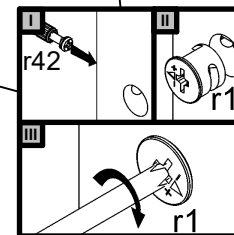
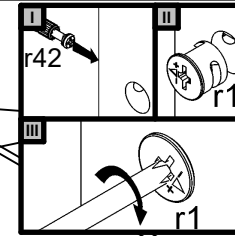
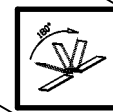
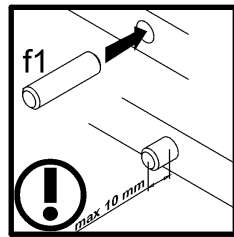
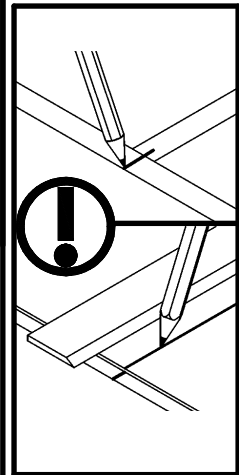
I





8x  f1
Ø8x30 mm

12x  r1
Ø15x12 mm #16

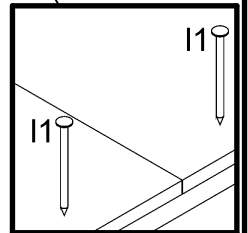
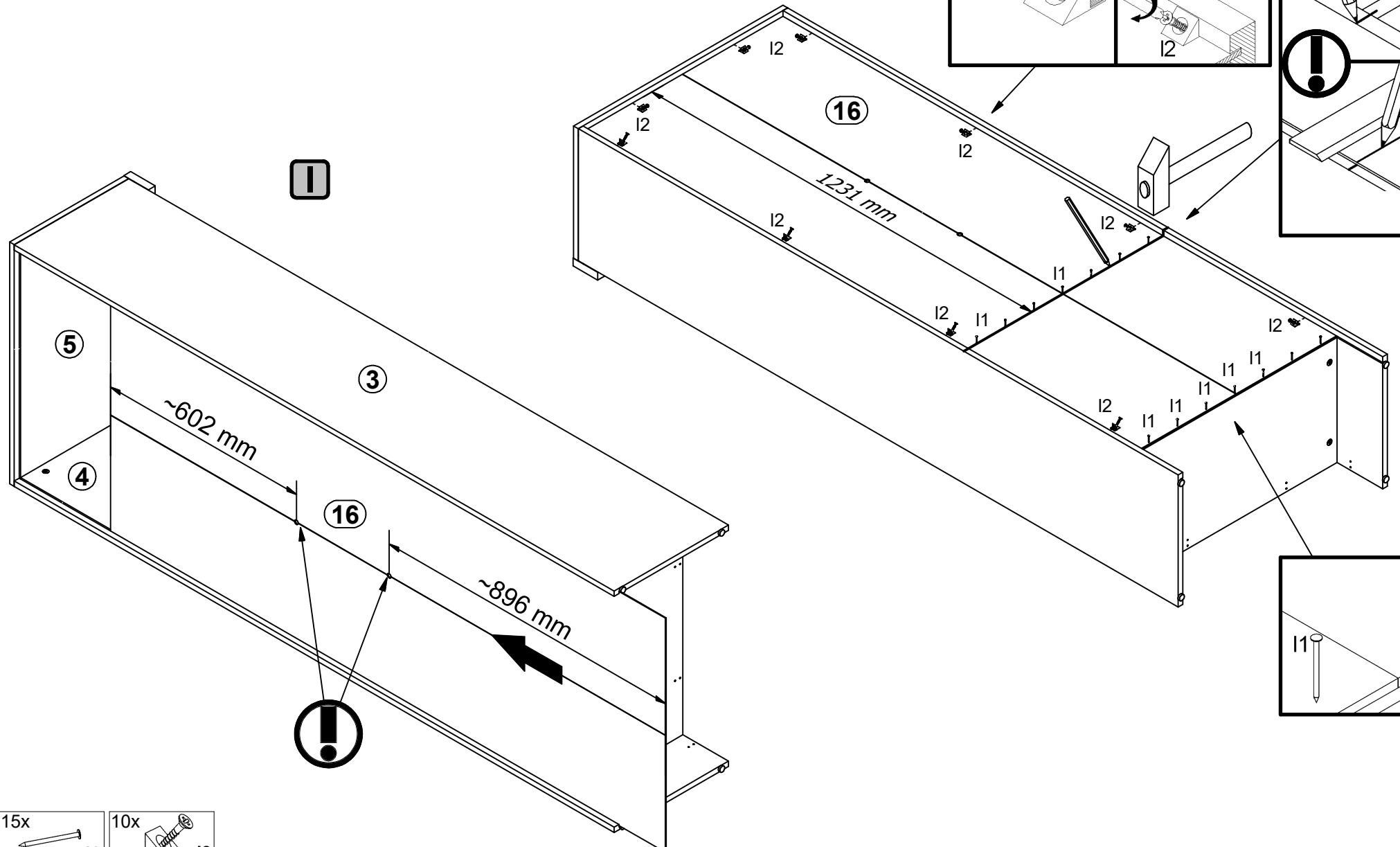
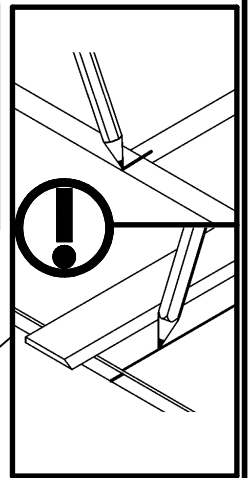
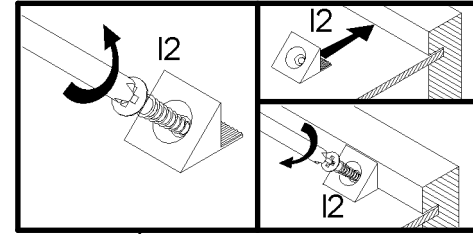
4 



- 15x  I1
- 10x  I2

5 §6

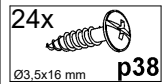
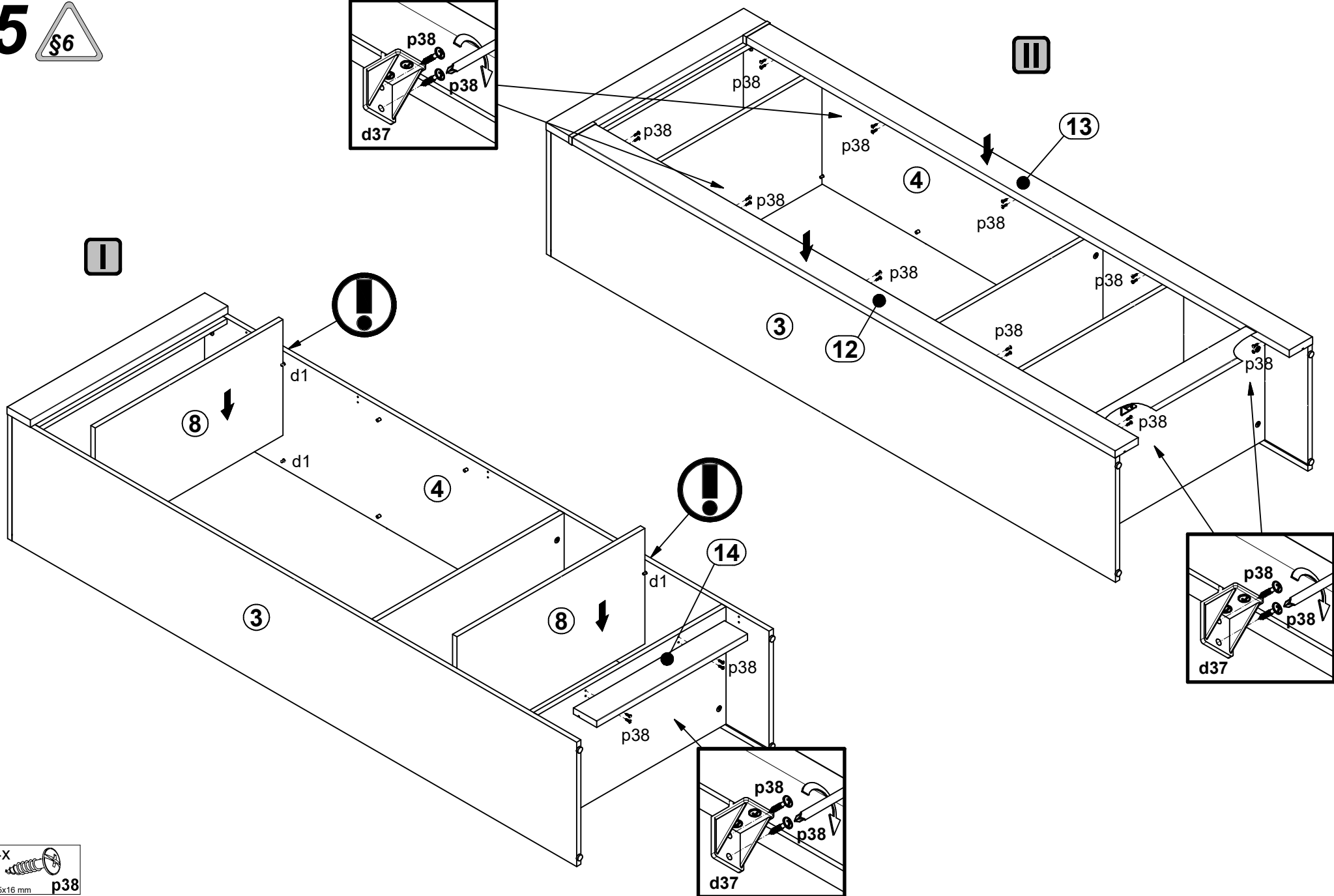
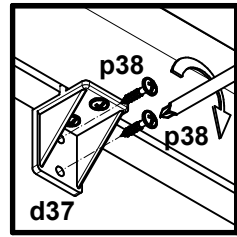



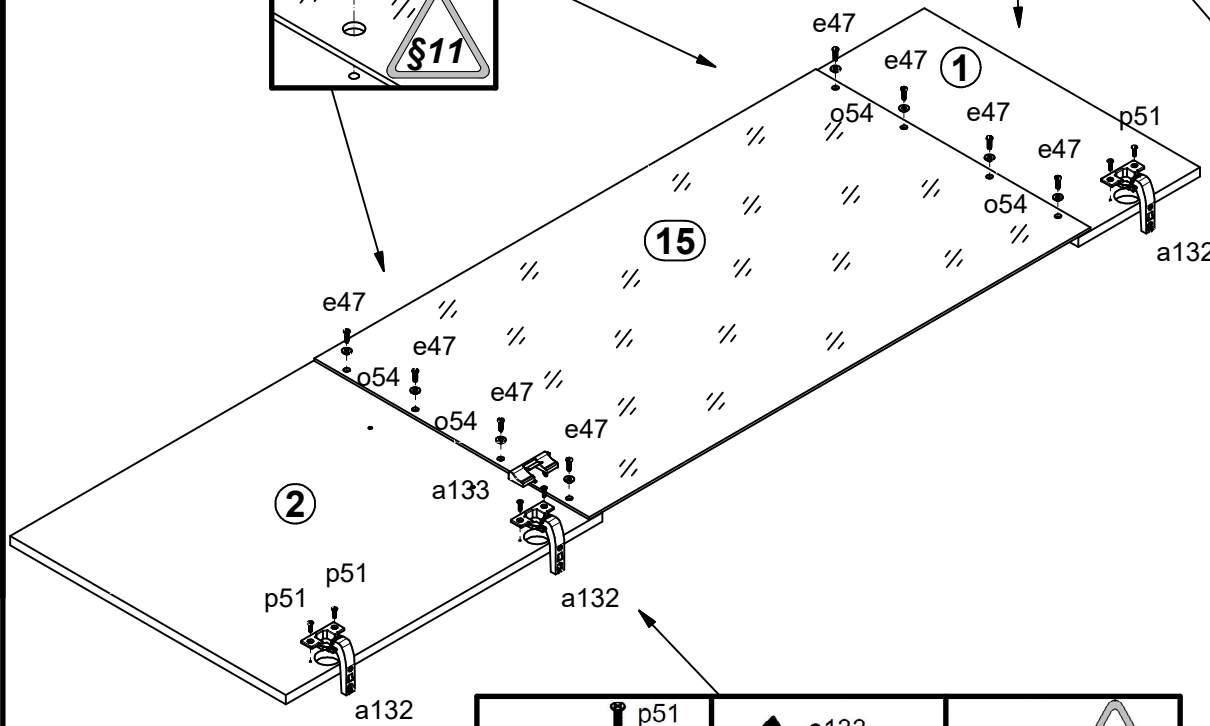
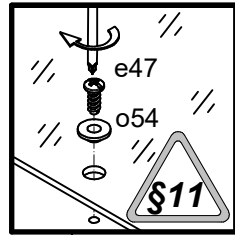
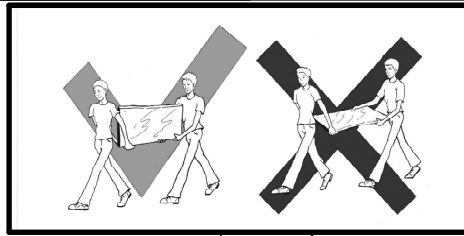

6 §2 §6 §11

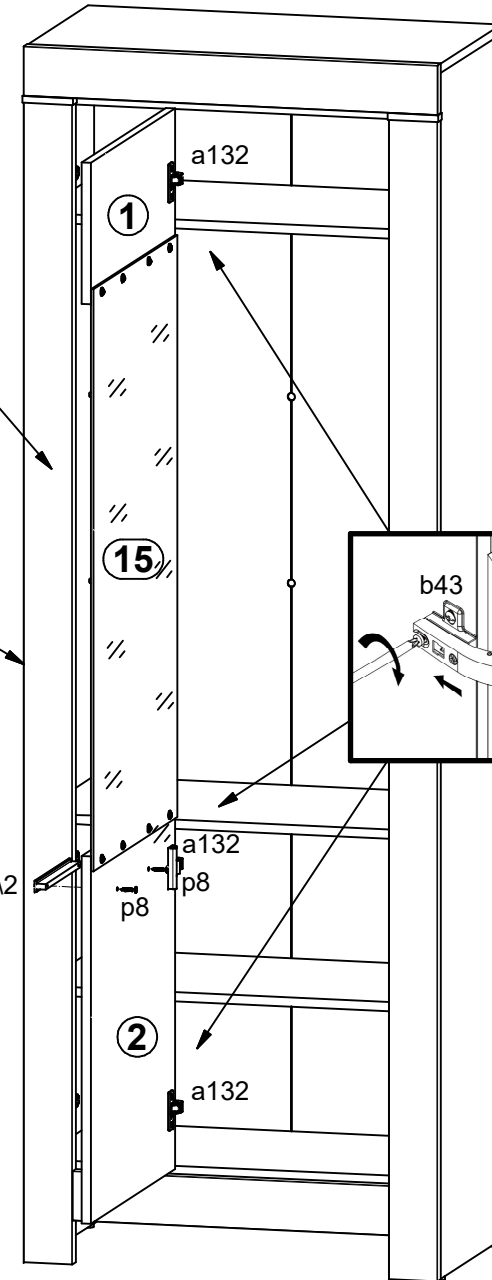
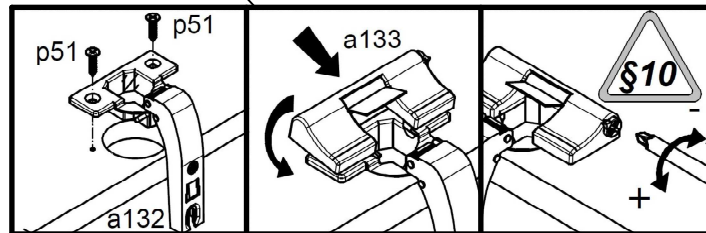
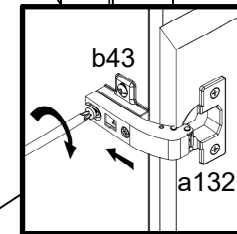

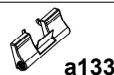
12

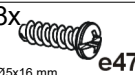

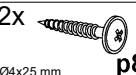
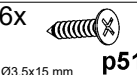
- 3x  a132
- 1x  a133
- 1x  c329\2
- 8x  e47
- 8x  o54
- 2x  p8
- 6x  p51

7 §11

