











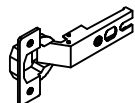

1

8

|   |   |   |   |   |   |   |   |   |
|---|---|---|---|---|---|---|---|---|
|  |  |  |  |  |  |  |  |  |
| 20  | 20  | 20  | 20  | 2   | 2   | 1   | 4   | 4   |
|  |  |  |  |  |   |   |   |   |
| 6   | 25  | 4   | 2   | 4   |   |   |   |   |

1

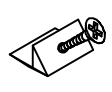
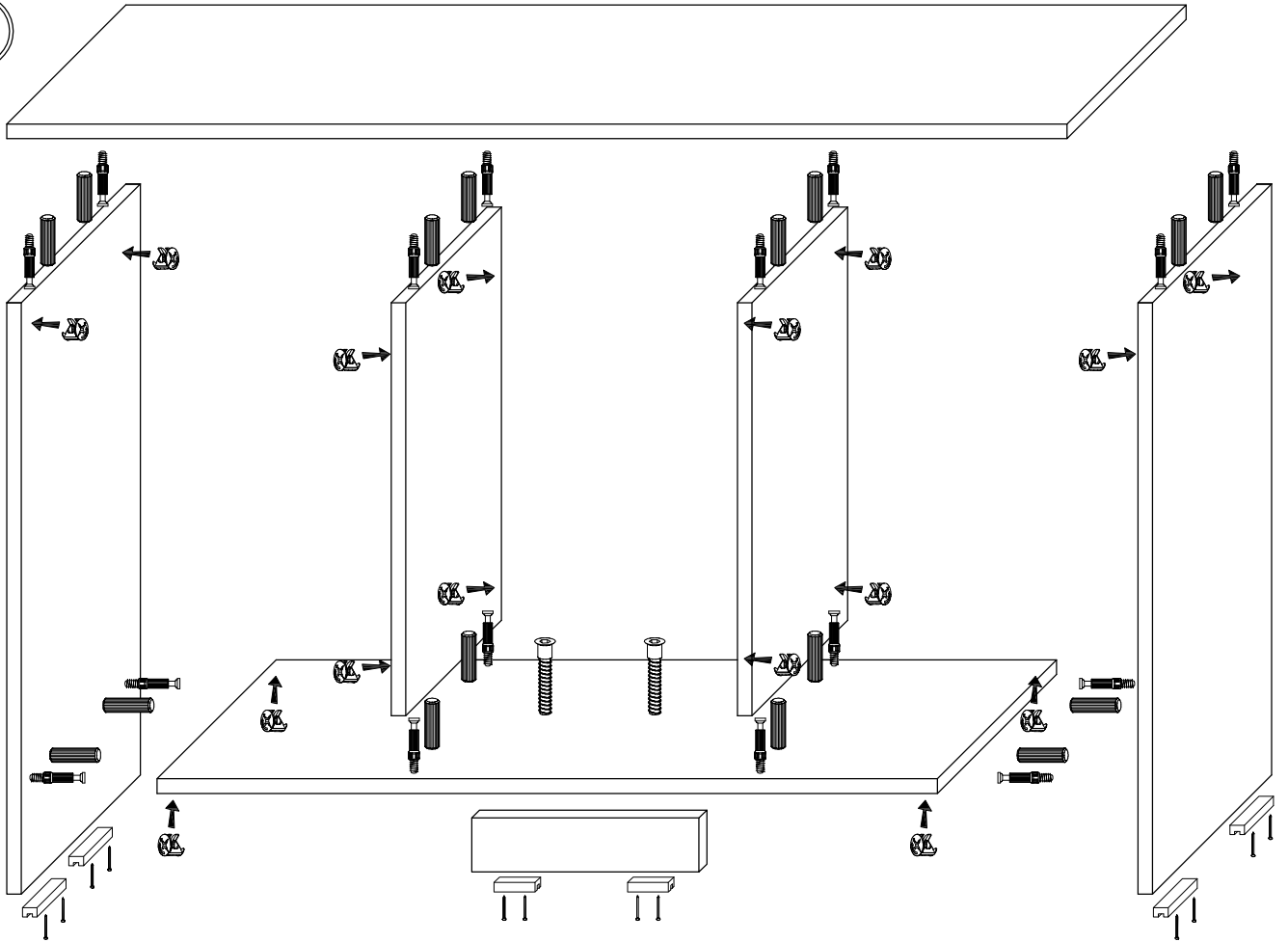

2

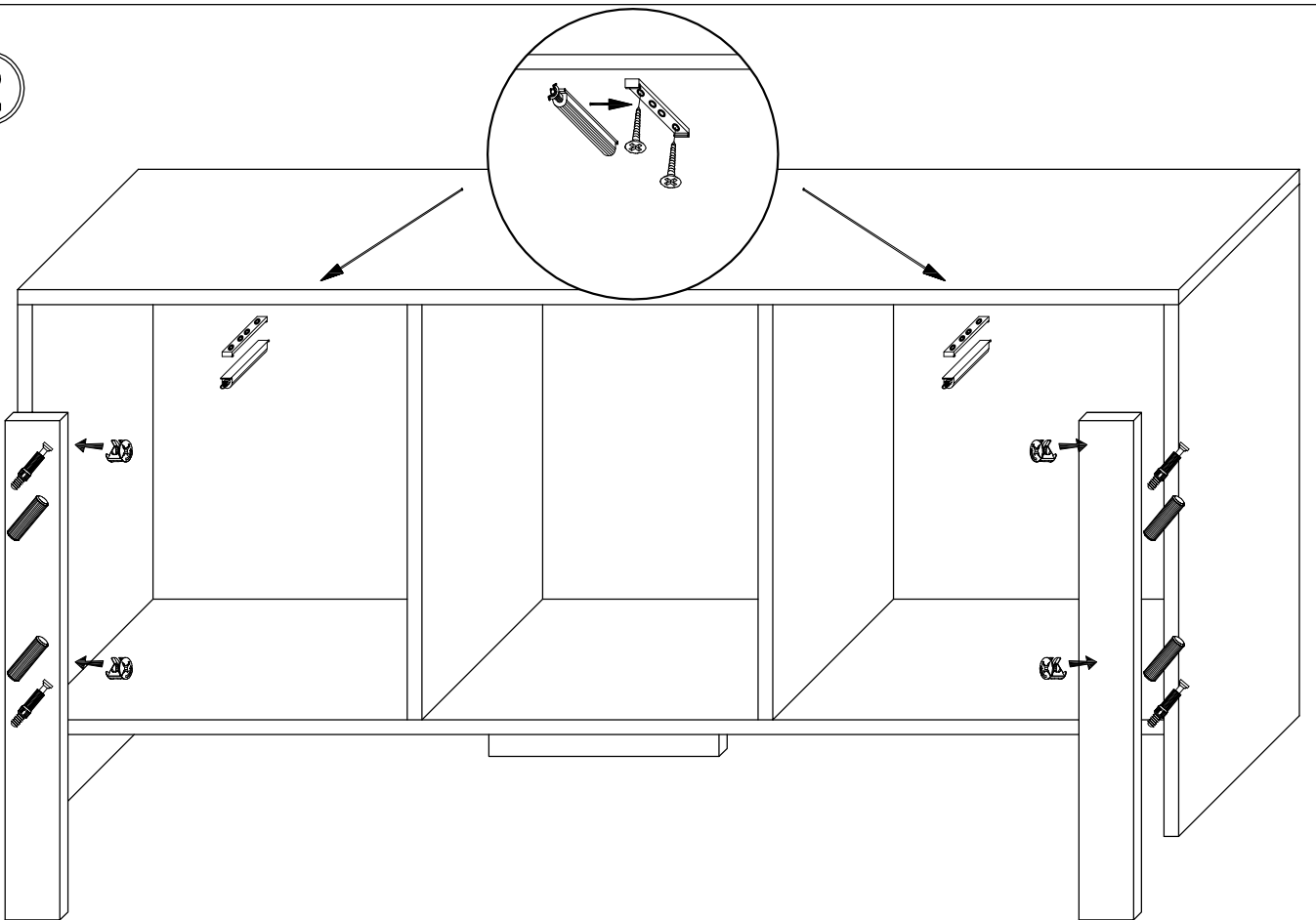

3

