

PRZED ROZPOCZĘCIEM MONTAŻU ZAPOZNAĆ SIĘ Z INSTRUKCJĄ

Narzędzia niezbędne do montażu (nie dostarczane przez producenta)

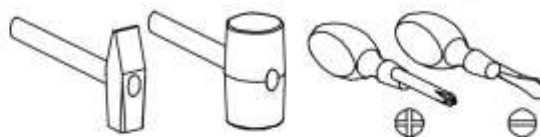

GOYA

RTV

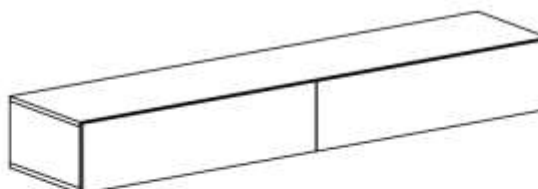
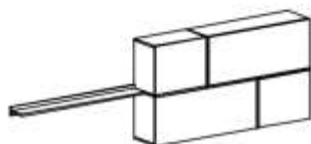

Nr	Nazwa elementu	Dł [mm]	Szer [mm]	Gr [mm]	Ilość	Kod	Paczka
1	blat górny	1800	382	16	1		
2	blat dolny	1800	382	16	1		
3	bok lewy	200	382	16	1		
4	przegroda śr.	200	379	16	1		
5	bok prawy	200	382	16	1		
6	HDF tył	1788	220	2,5	1		
7	kłapa lewa	895	228	16	1		
8	kłapa prawa	895	228	16	1		
9	przegroda lewa	200	379	16	1		
10	przegroda prawa	200	379	16	1		

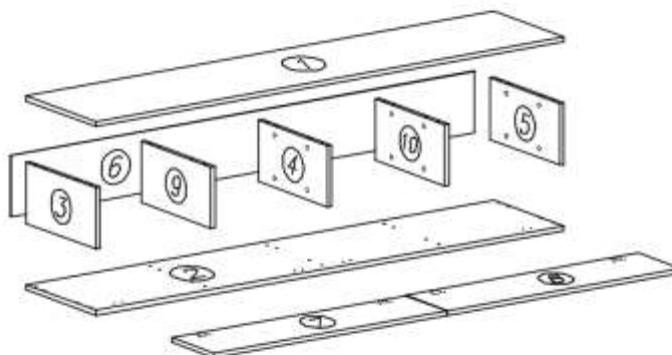

L6



L9



K5



K1



G31

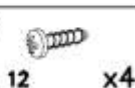

C3

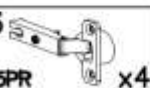

G30

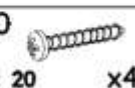

D3



G34

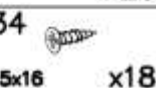

B1



P5

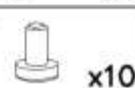

W2



W4



PZ35PR

x4

3,5x16

x18

x20

x10

x1

x40

