

# DUCA DC I

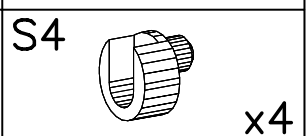

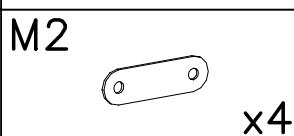

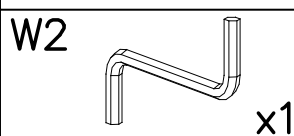

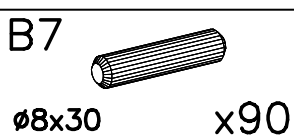
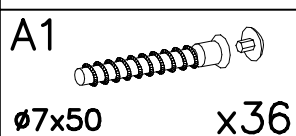
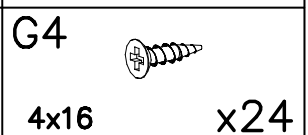
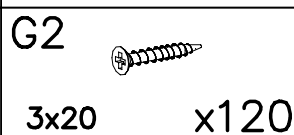
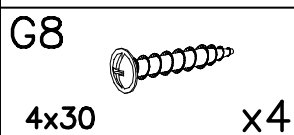
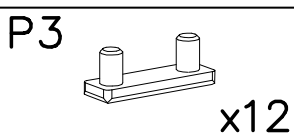
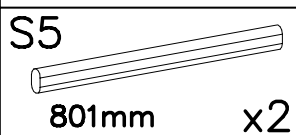
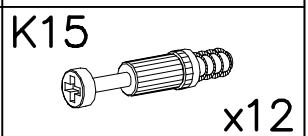
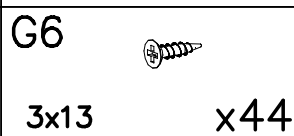
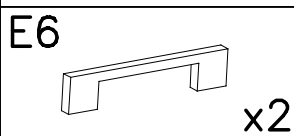
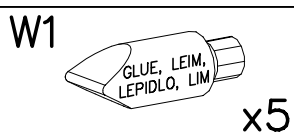
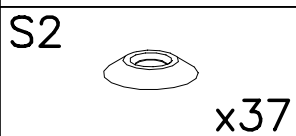
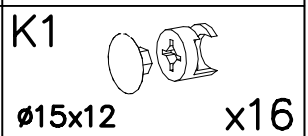
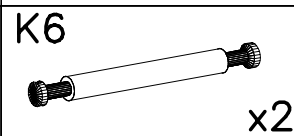
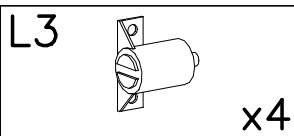
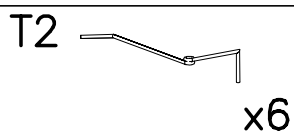
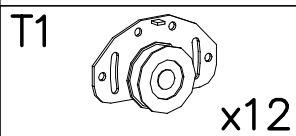
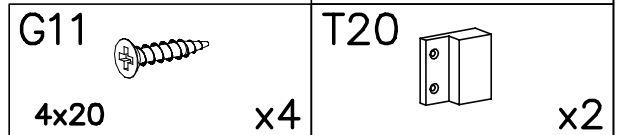
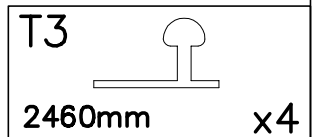
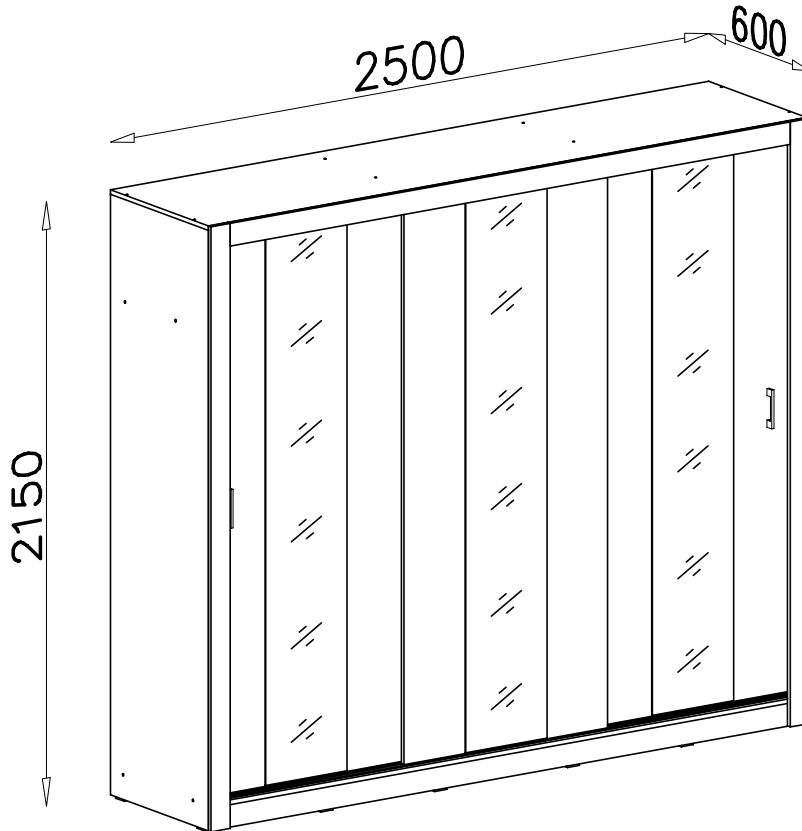
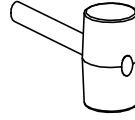
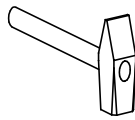
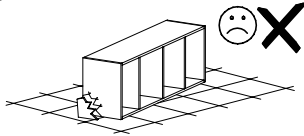
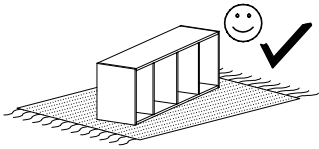
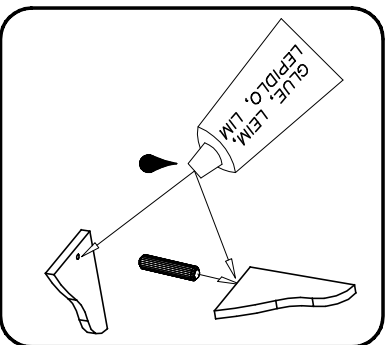
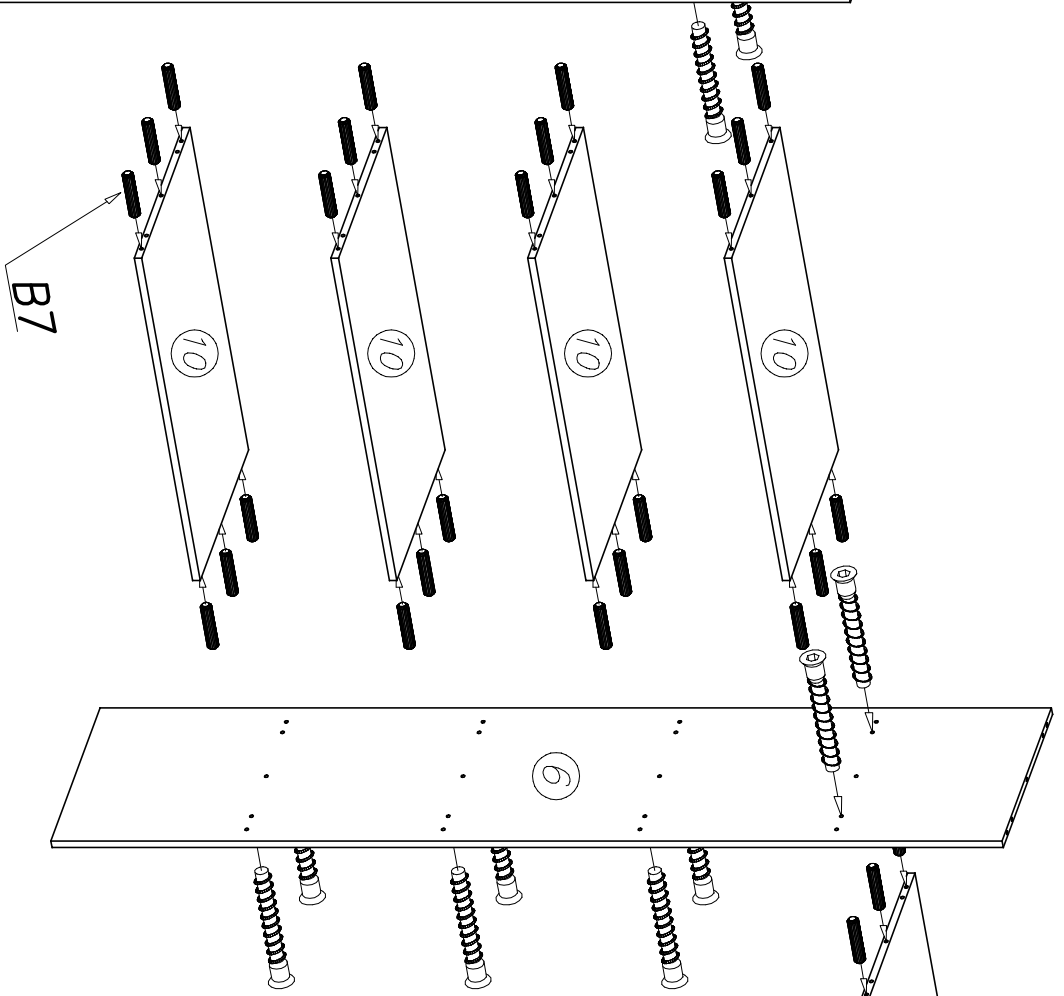
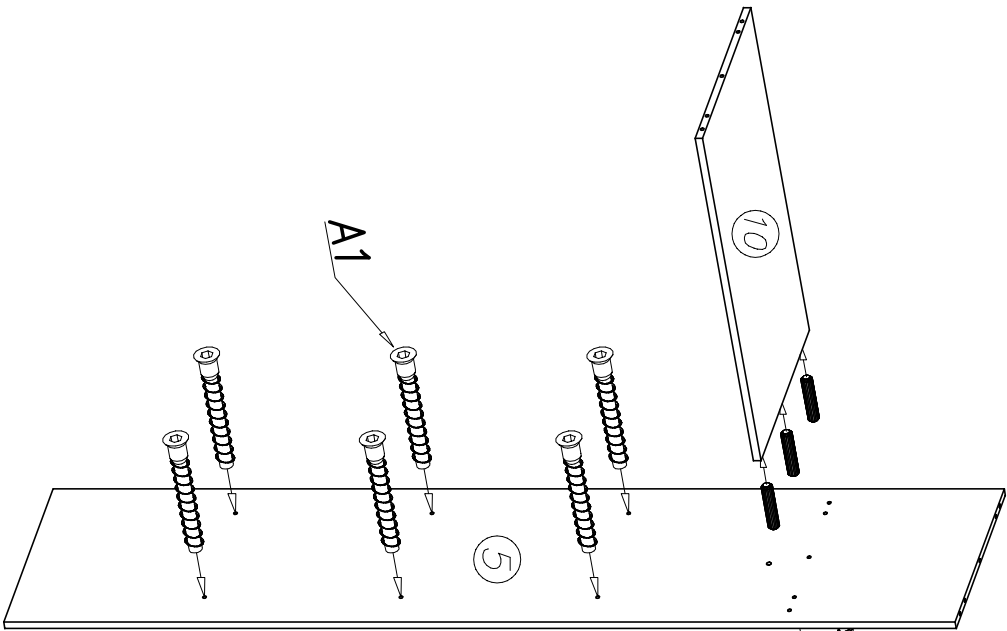
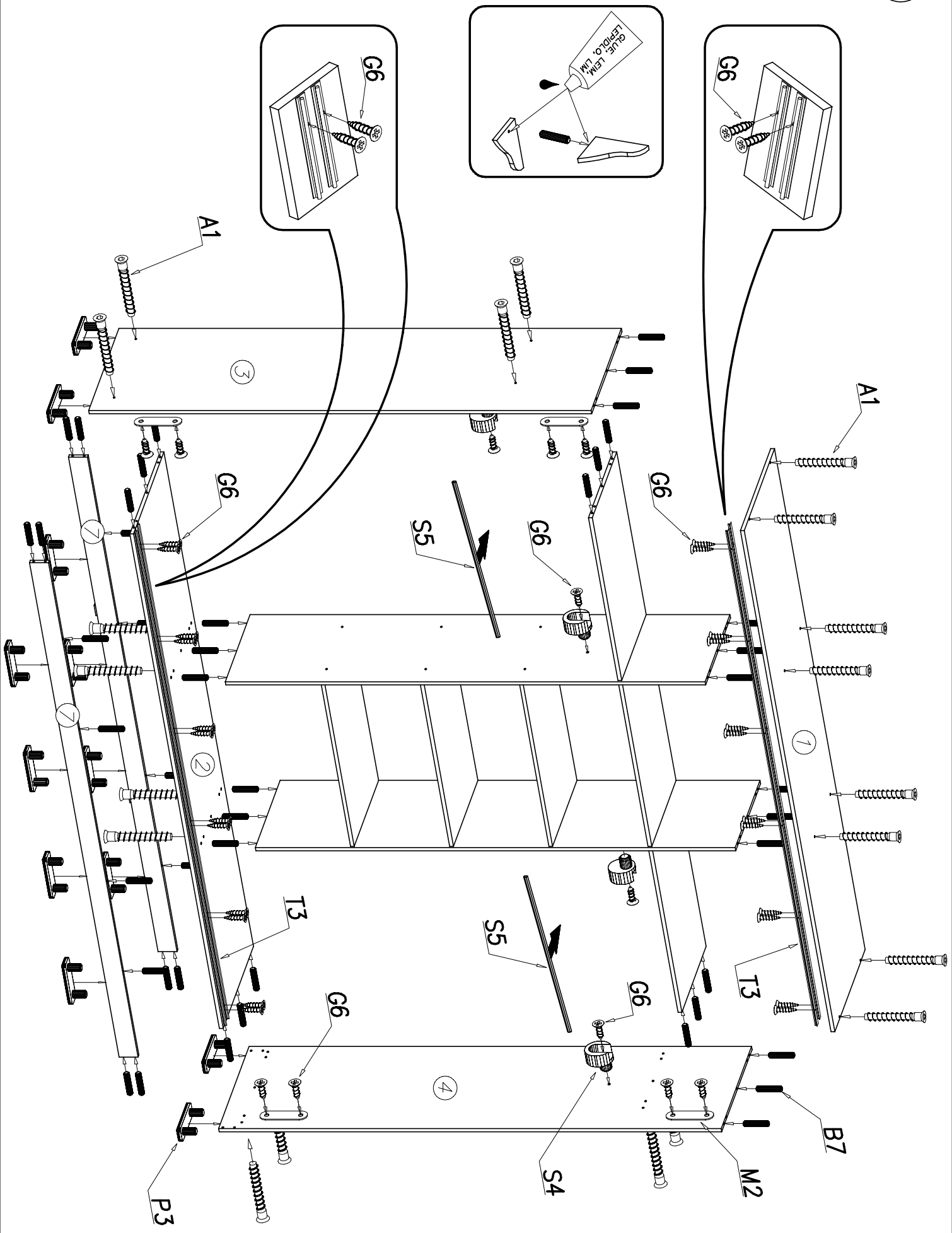
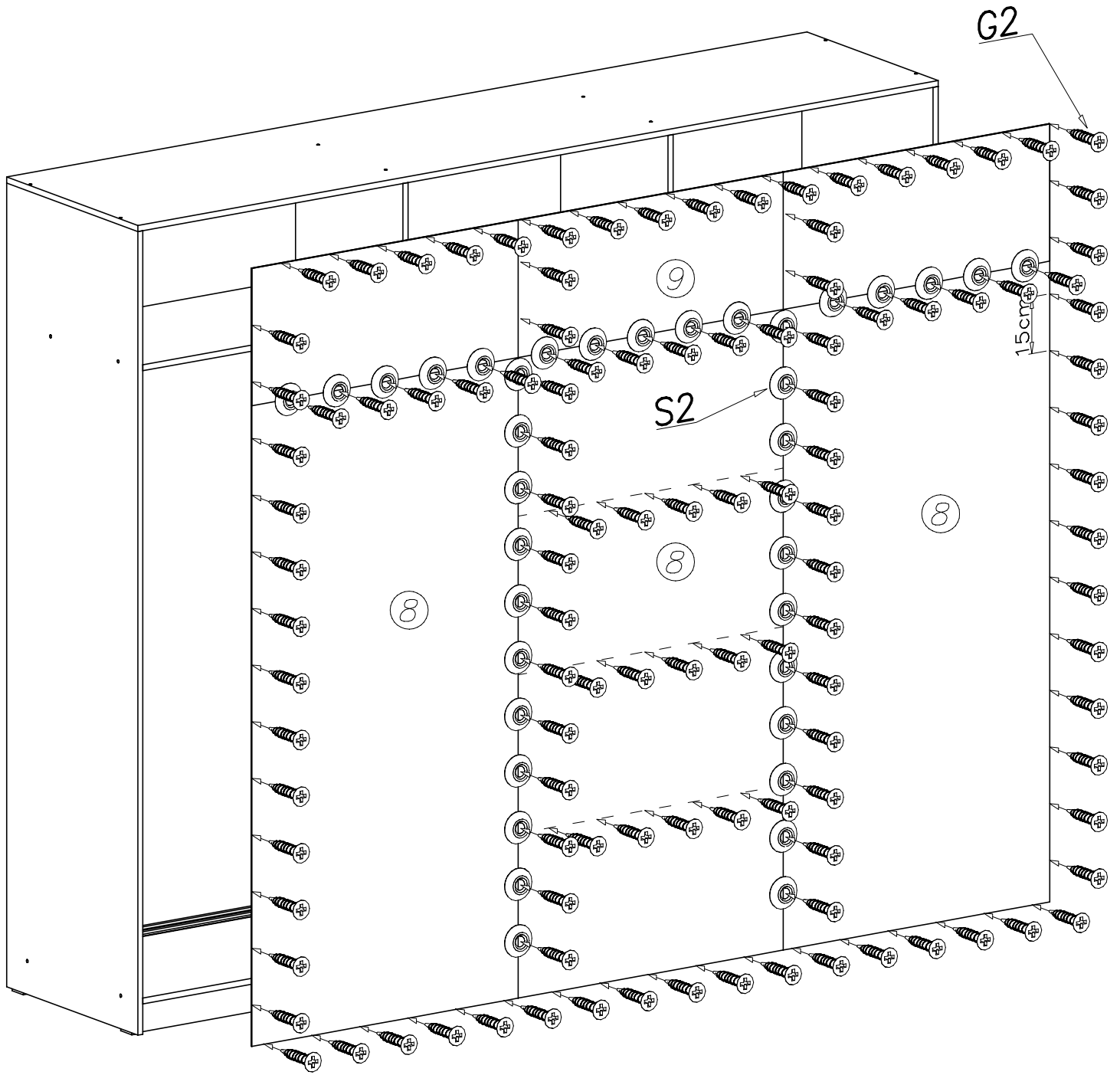

IV

E6

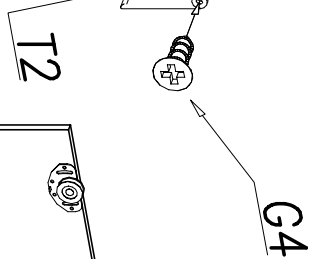
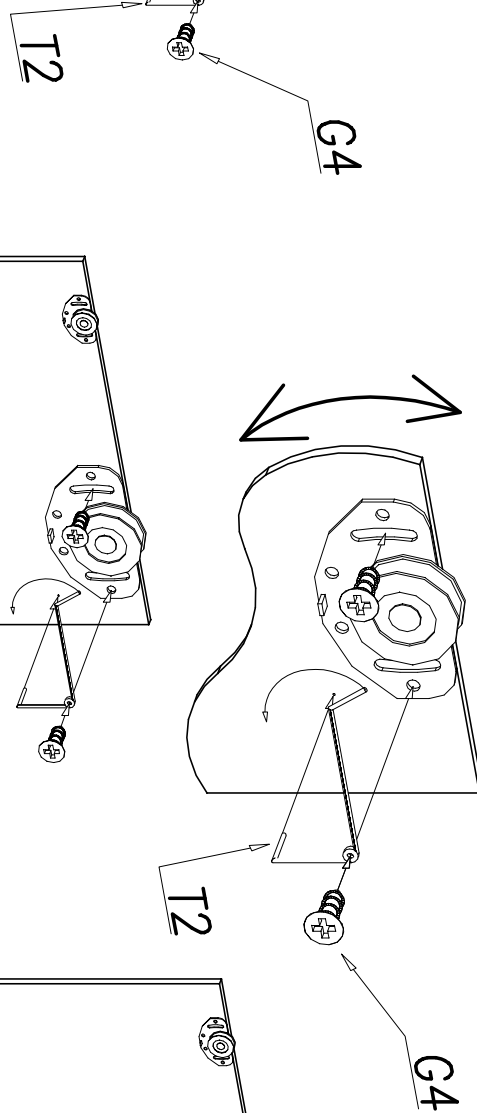
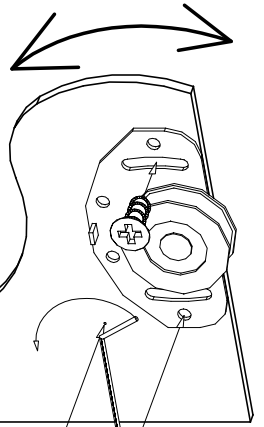
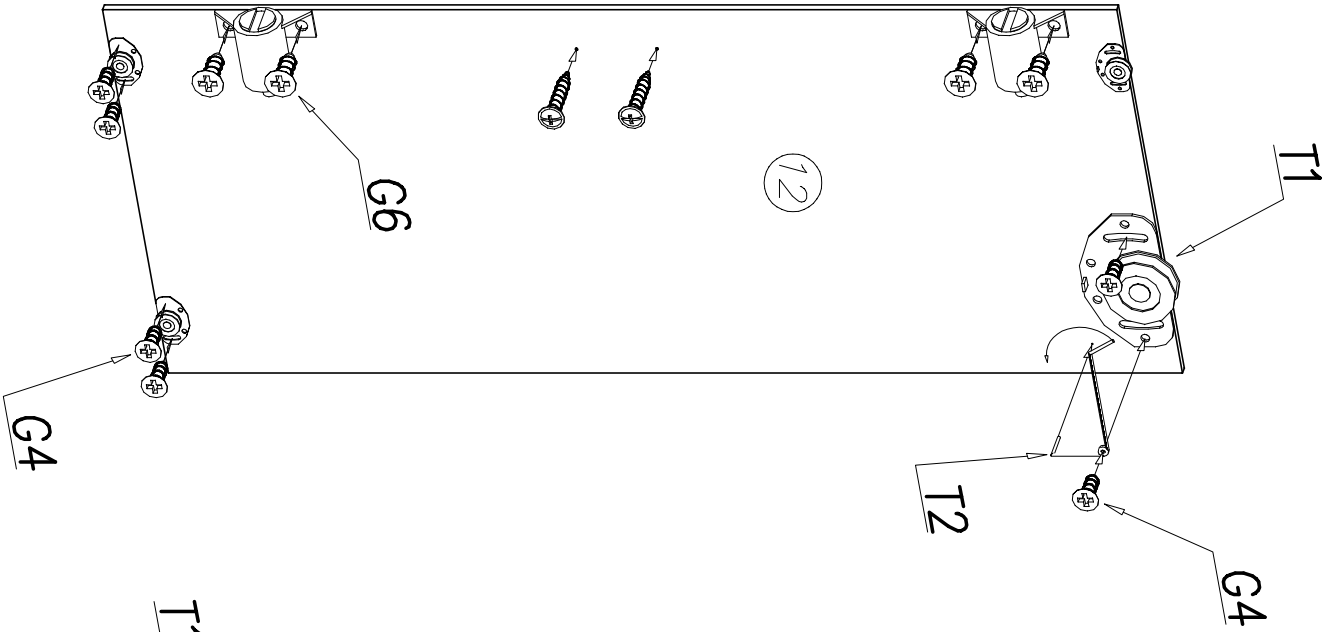

11

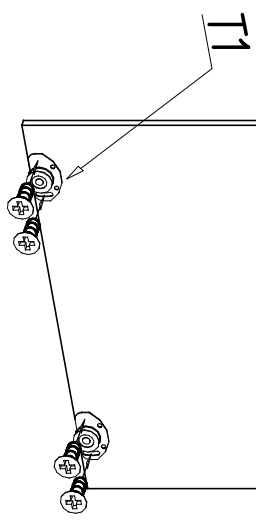
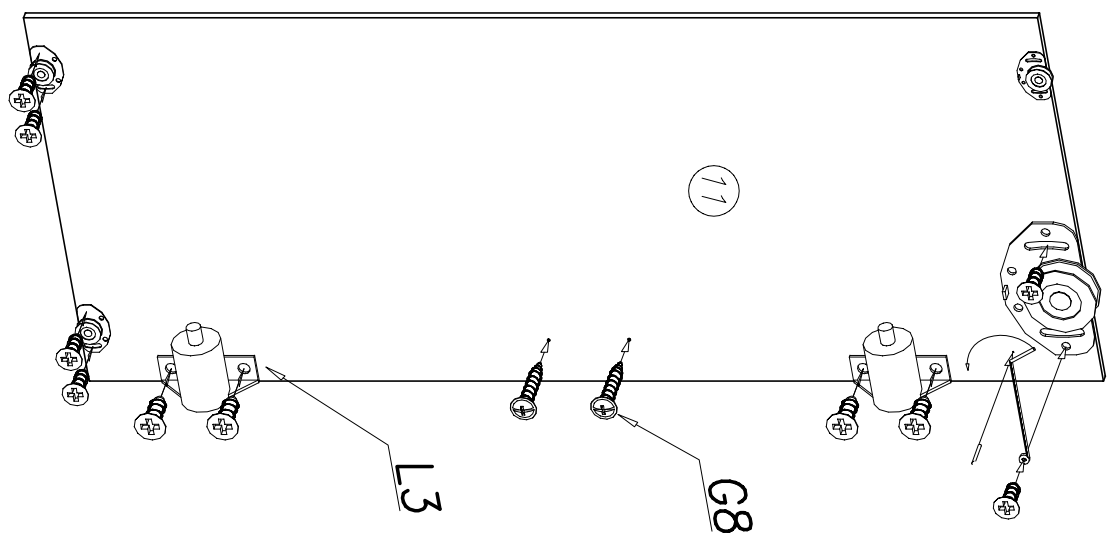

V

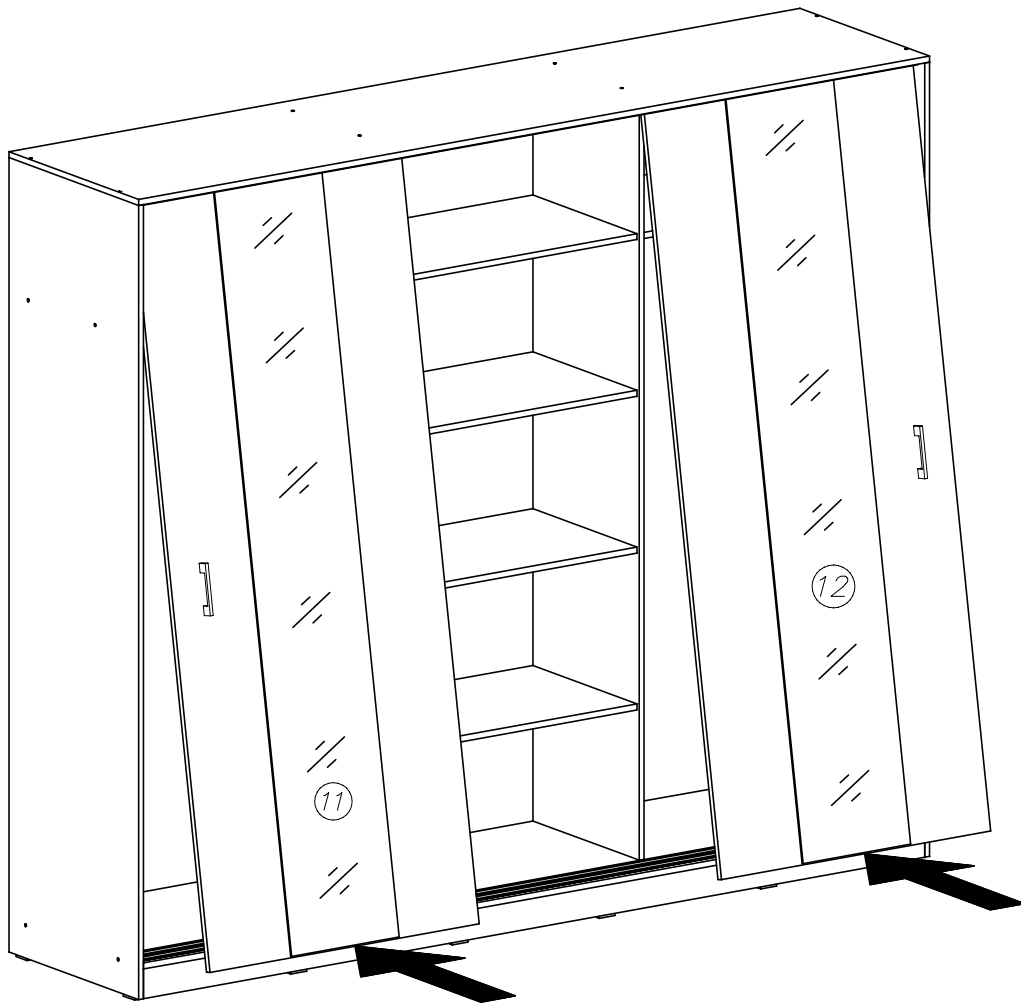

VI

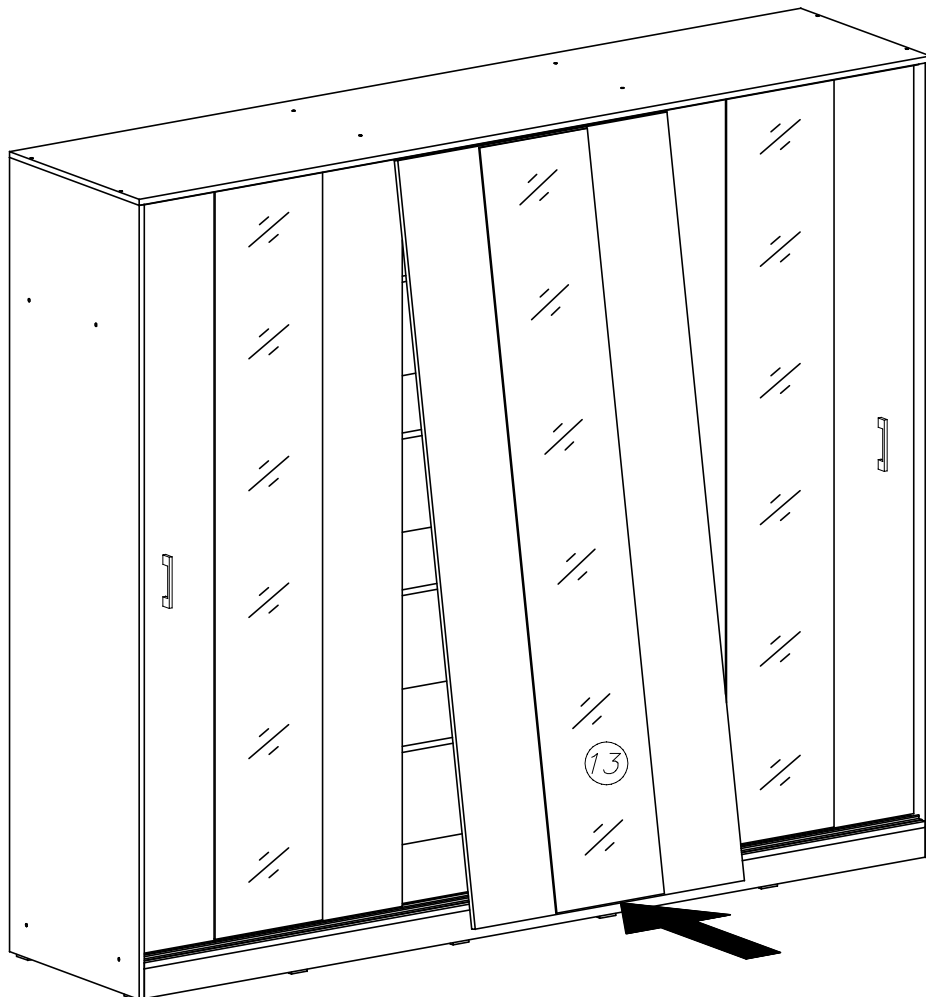

VII

