

ASSEMBLY INSTRUCTION FOR PSN 1102-DT-SW (TOALETKA 1102)

<p>Note:</p> <ul style="list-style-type: none"> • Read the instruction carefully. • Do not touch the sharp edges of the product. • Do not use the product for purposes not intended. • Do not use the product in wet areas. • Do not use the product in areas with high humidity. • Do not use the product in areas with high temperature. • Do not use the product in areas with high salt content. • Do not use the product in areas with high acid content. • Do not use the product in areas with high alkaline content. 	 2 Persons	TOOL REQUIRED 
--	---	---

STEP 1

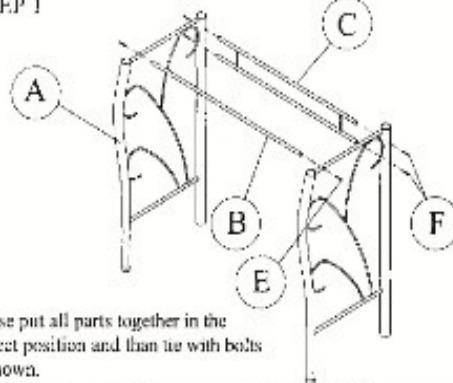

Please put all parts together in the correct position and then tie with bolts as shown.

STEP 2

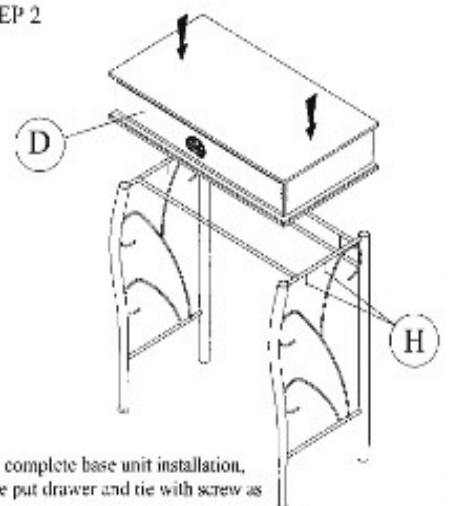

After complete base unit installation, please put drawer and tie with screw as shown.

STEP 3

Fix the Mirror to dresser with two option as shown in diagram.

Option 1

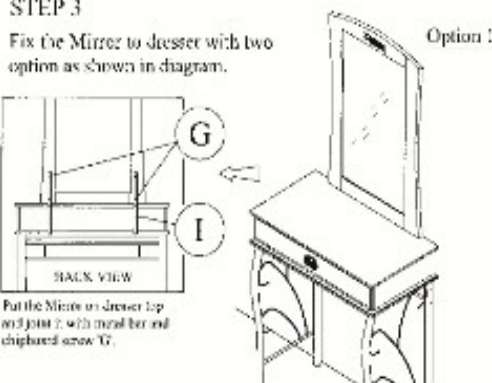





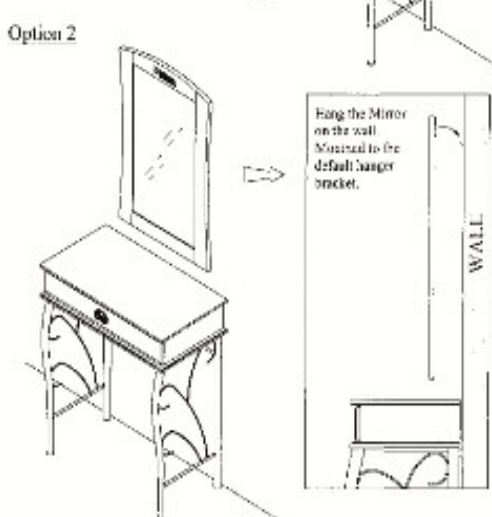

Put the Mirror on Dresser top and joint I with metal bar and chipboard screw G.

Option 2

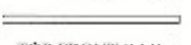

Hang the Mirror on the wall. Mount it to the default hanger bracket.

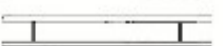
PART & HARDWARE LIST FOR PSN 1102-DT-SW

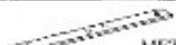
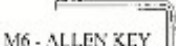
NO	PART	QTY	NO	PART	QTY
A	 SIDE FRAME LEFT RIGHT	1 pc	E	 M6x25mm	2 pcs
		1 pc	F	 M6x50mm	4 pcs
B	 TOP FRONT RAIL	1 pc	G	 CHIPBOARD SCREW #4 x 20mm	8 pcs
C	 TOP BACK FRAME	1 pc	H	 CHIPBOARD SCREW #4 x 30mm	4 pcs
D	 DRAWER	1 unit	I	 METAL BAR	2 pcs
				 M6 - ALLEN KEY	1 pc

Please follow our Assembly Instruction procedure for easier assemble.