

# SZAFKA WYSOKA 1 DRZWI 80-30-1D

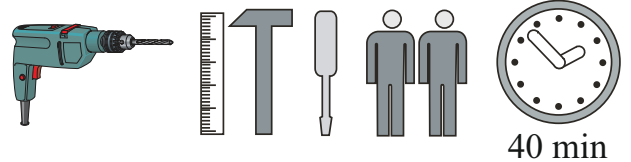

NO	Dim.			Col.-No	Qty
1	1400	236	16	1	2
2	268	235	16	1	2
3	268	212	16	1	1
4	268	204	16	1	2
5	1398	298	16	1	1
6	1376	278	3	1	1

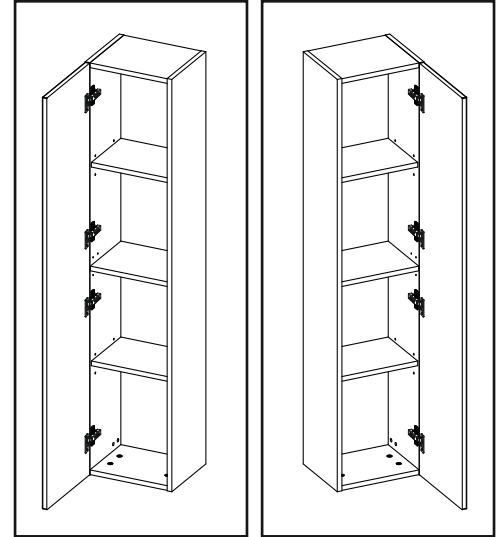

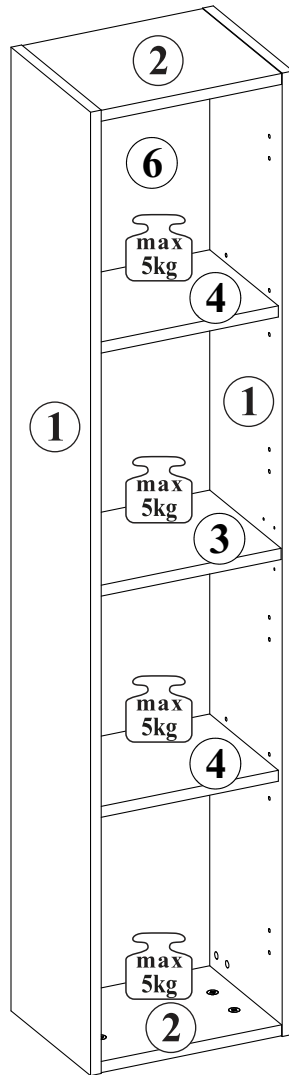
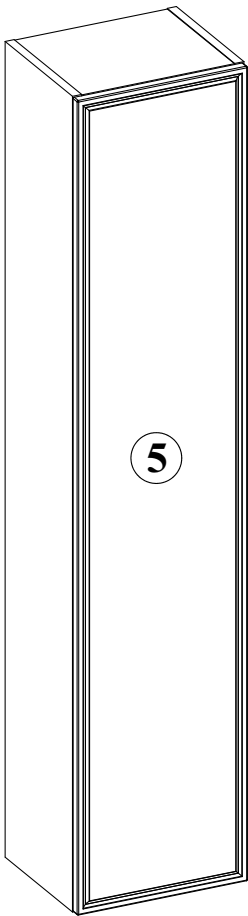
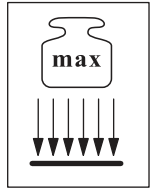
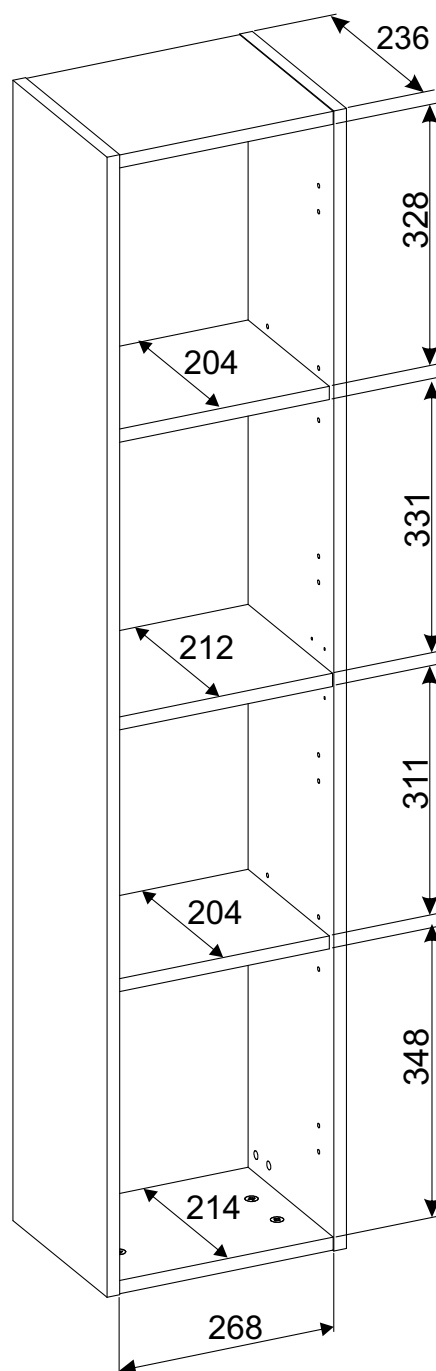
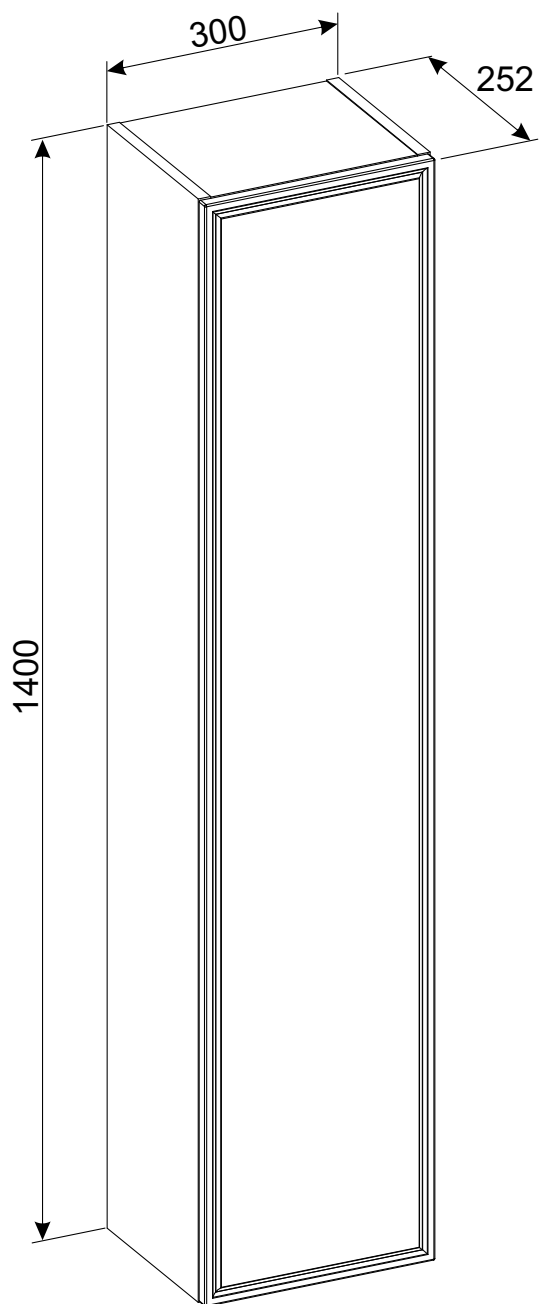



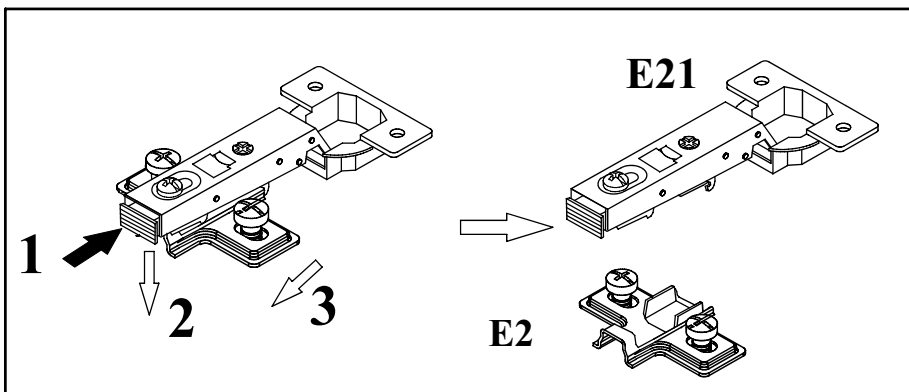
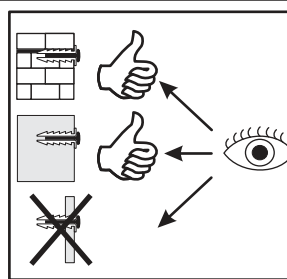
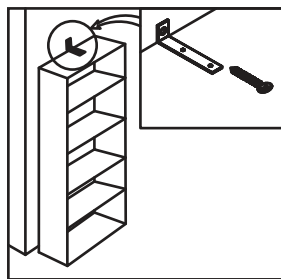
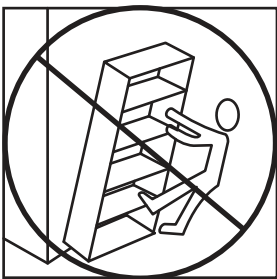
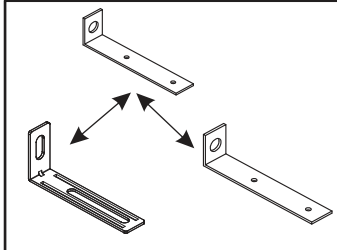
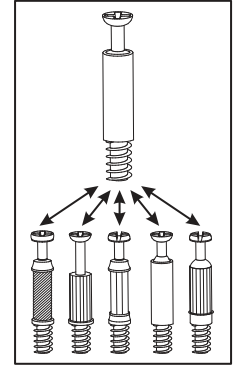
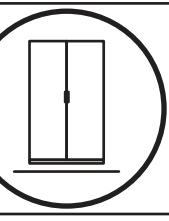
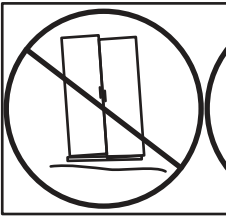
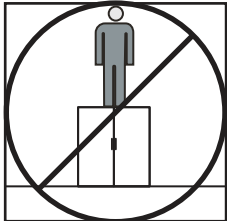
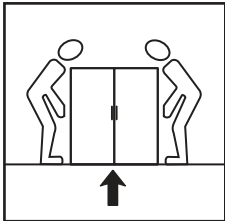
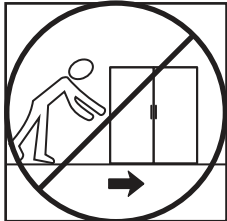
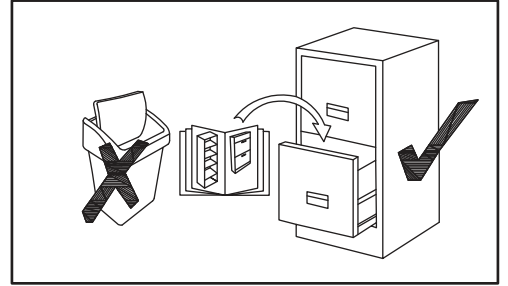
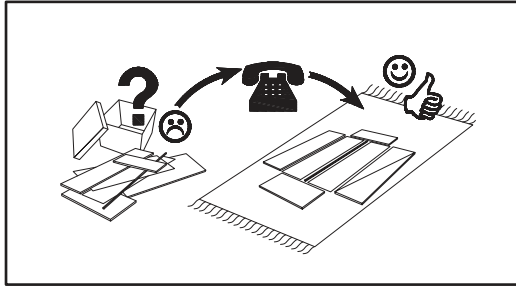
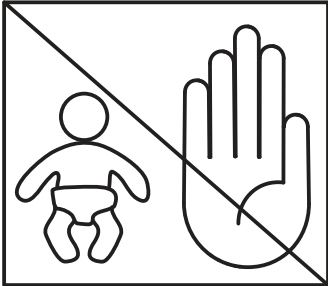
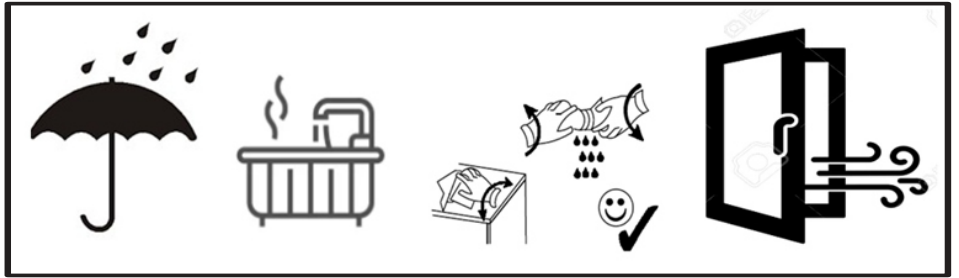
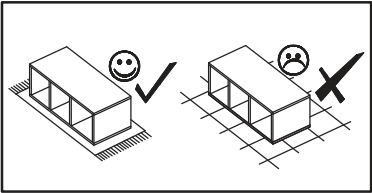
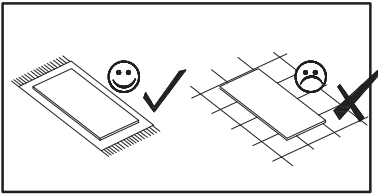

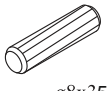
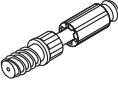

# SZAFKA WYSOKA 1 DRZWI 80-30-1D

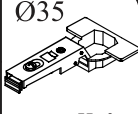
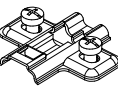

**SZAFKA WYSOKA  
1 DRZWI 80-30-1D**

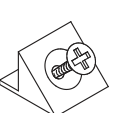
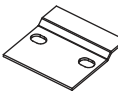

**SZAFKA WYSOKA  
1 DRZWI 80-30-1D**

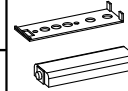
A1 x12  ø8x35	B4 x12 	B5 x12  ø15x12	G5 x12 	ZXP x1 	ZXL x1 
E21 x4  Ø35 H=0	E2 x4  H=0	D10 x10  USØ3,5x13	G7 x8 	Z2 x8  Ø5	Z5 x4  Ø10
S1 x6 	SZ7 x2 	UP13 x3  UPØ3x20	D6 x4  USØ4x30	G04 x1 	

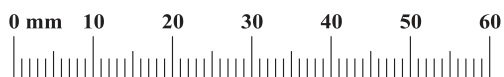

**SZAFKA WYSOKA  
1 DRZWI 80-30-1D**

**1**

D6	
x4	USØ3,5x30

Z5	
x4	Ø10

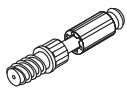
B4	
x12	

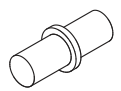
G7	
x8	

ZXP	
x1	

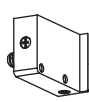
ZXL	
x1	

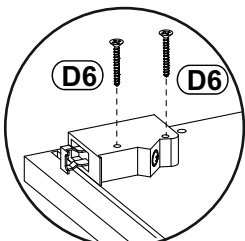
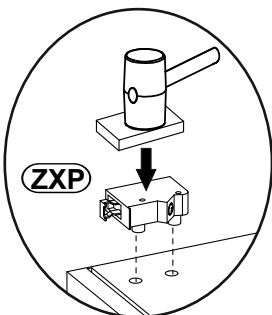
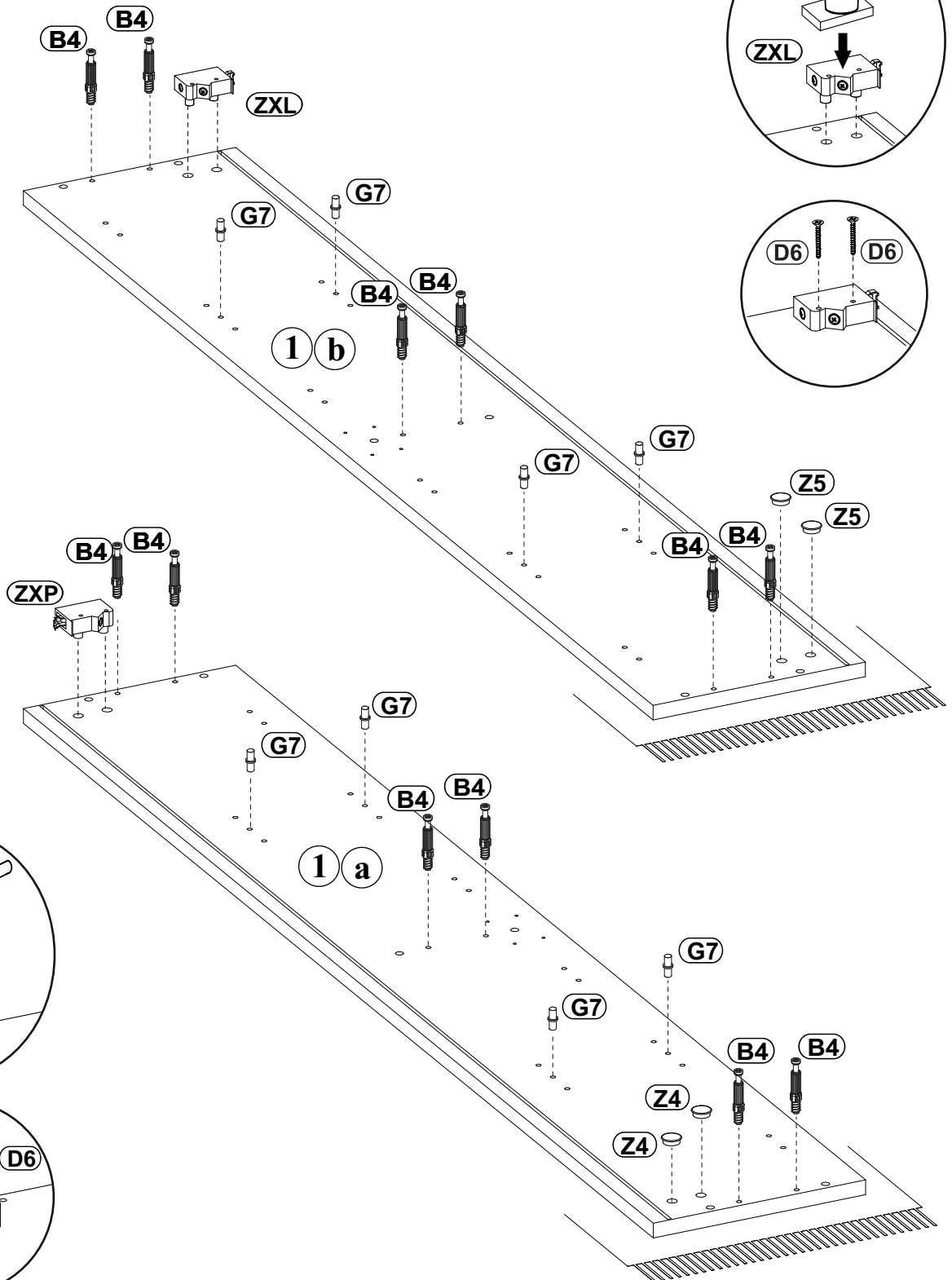
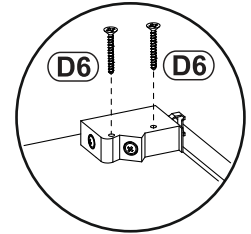
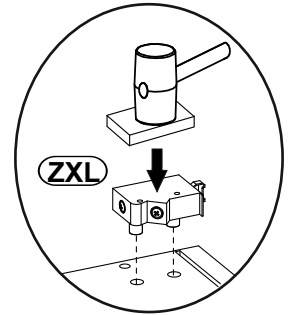
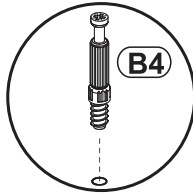
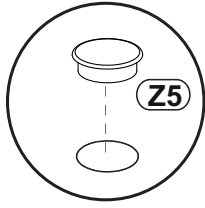
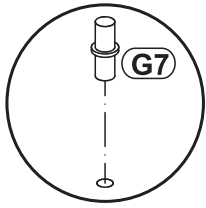

SZAFKA WYSOKA  
1 DRZWI 80-30-1D

2

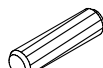
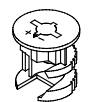
A1		B5	
x12	ø8x36	x12	ø15x12

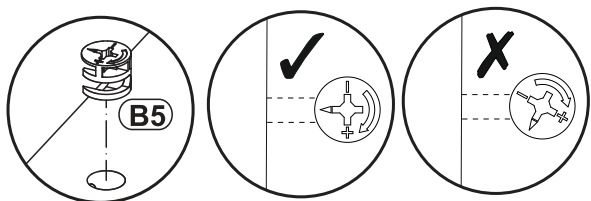
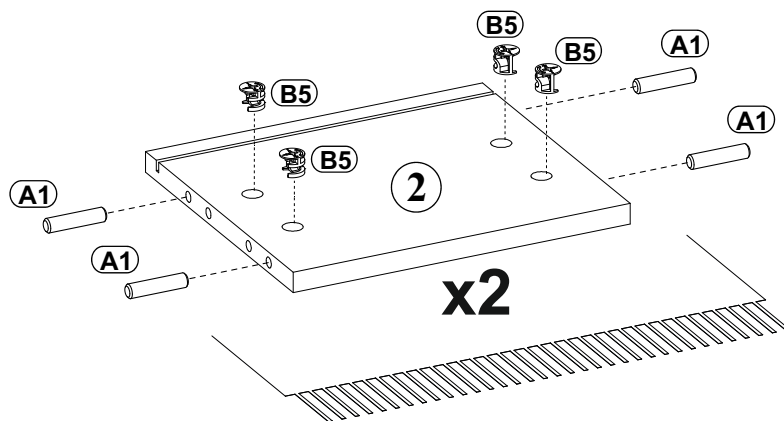
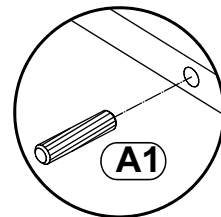
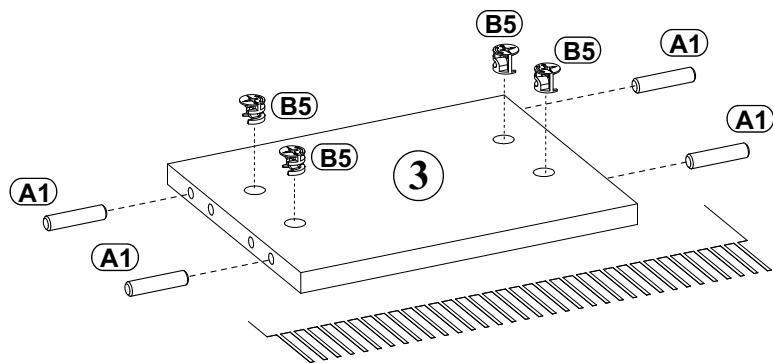

3

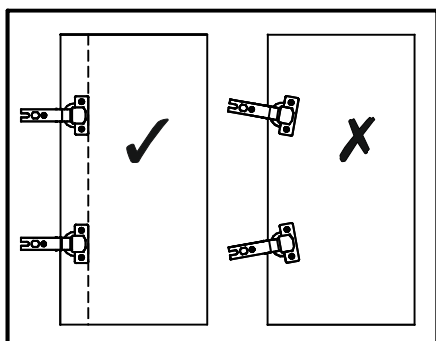

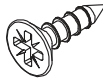
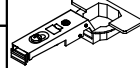
D10		E7	
x8	USØ3,5x13	x4	Ø35 H=0

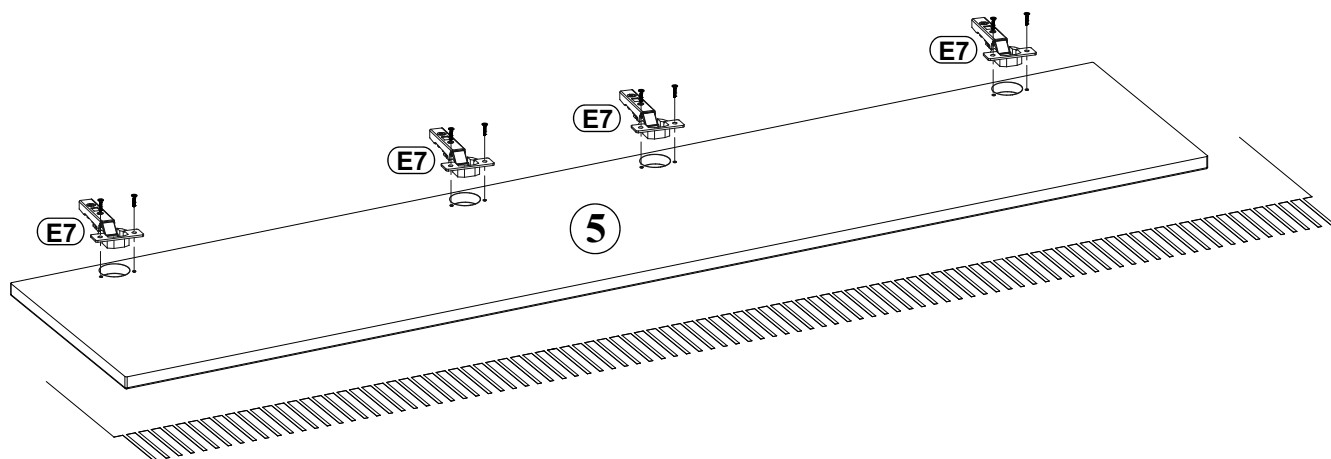
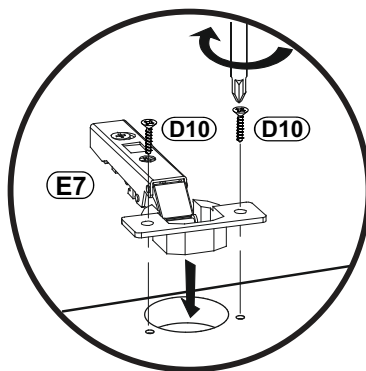

SZAFKA WYSOKA  
1 DRZWI 80-30-1D

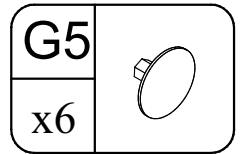

4

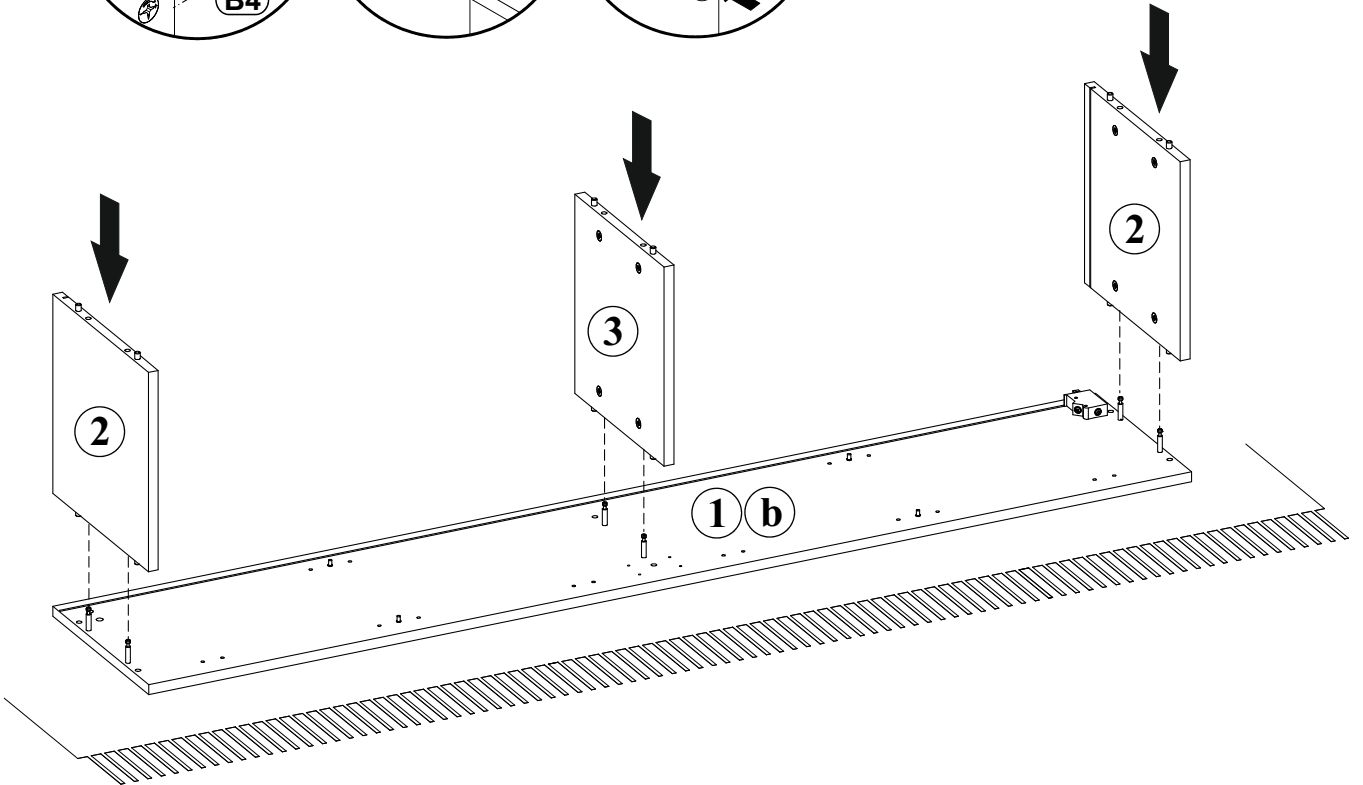
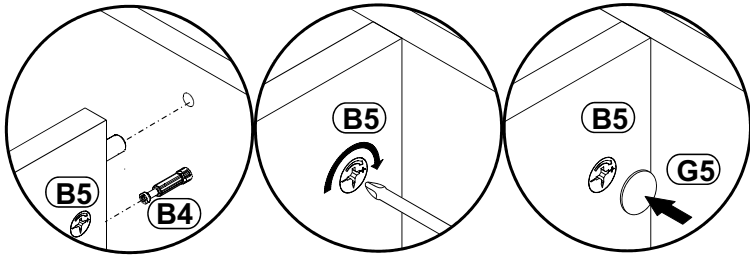

5

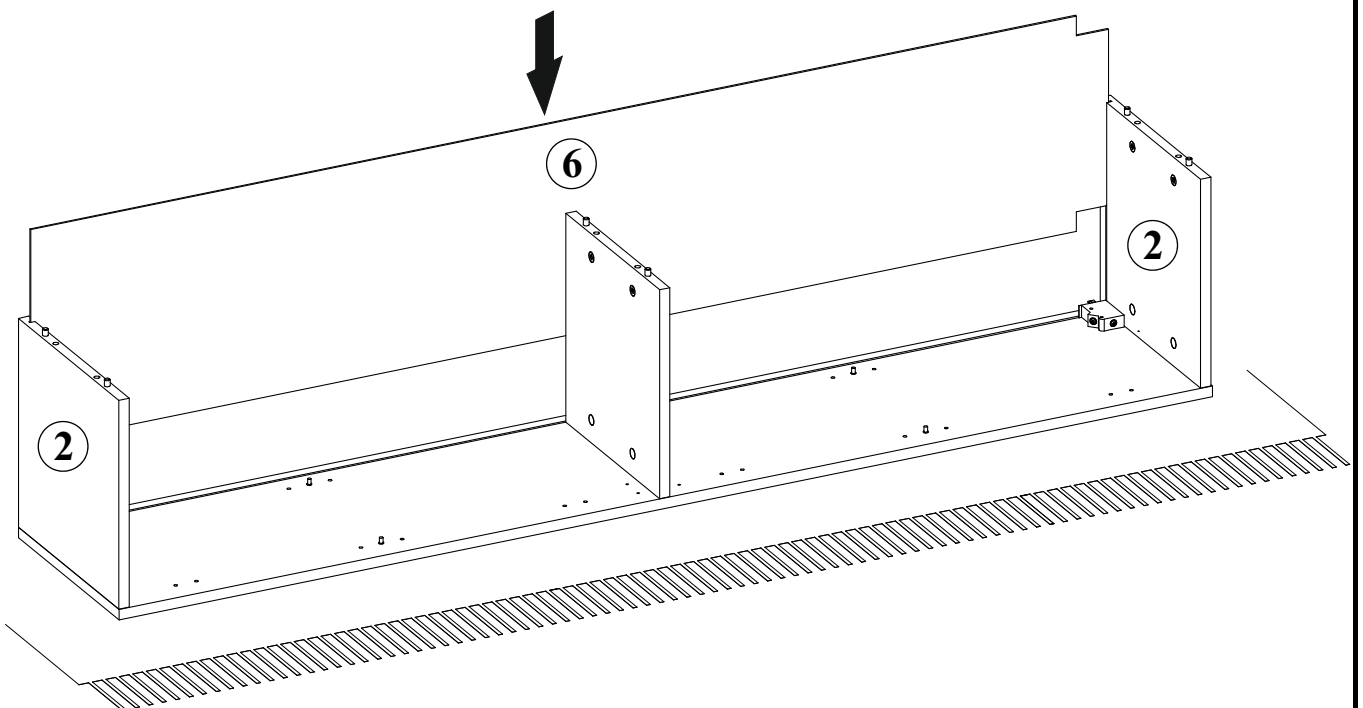

SZAFKA WYSOKA  
1 DRZWI 80-30-1D

G5	
x6	

6

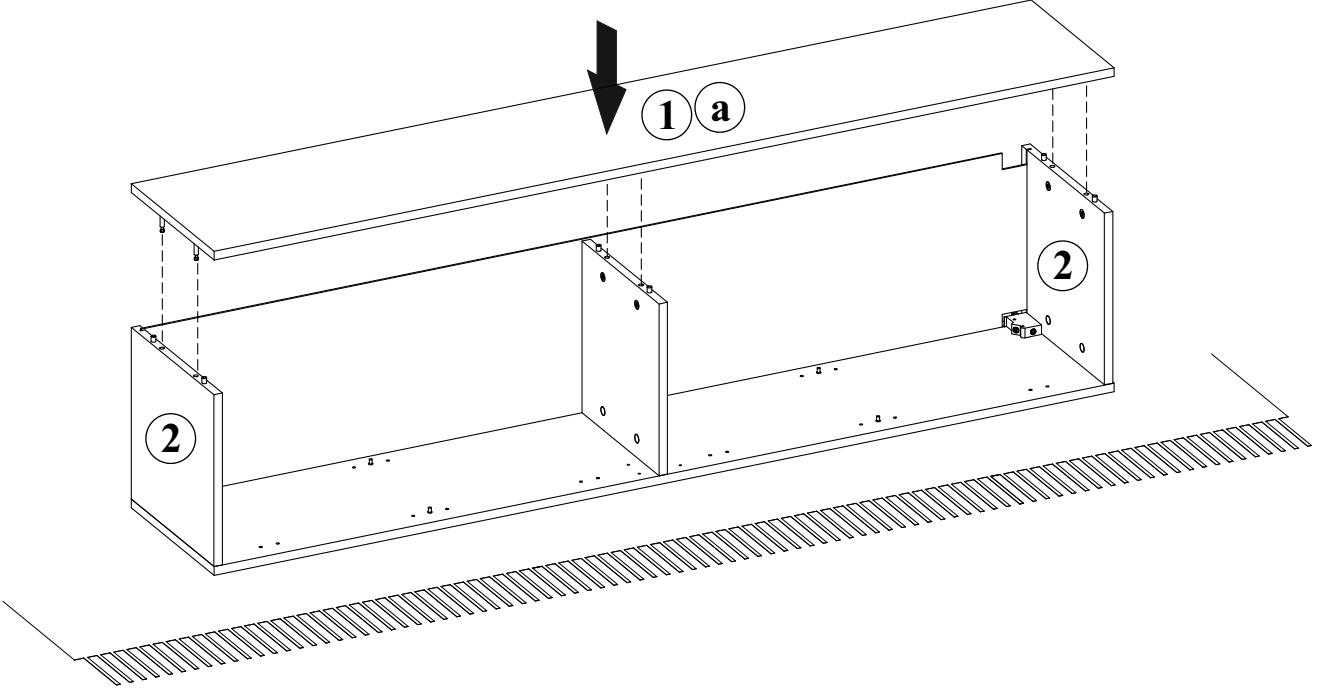
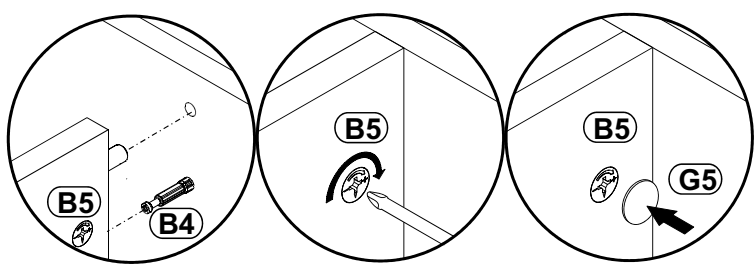

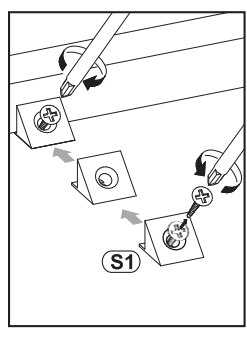

7

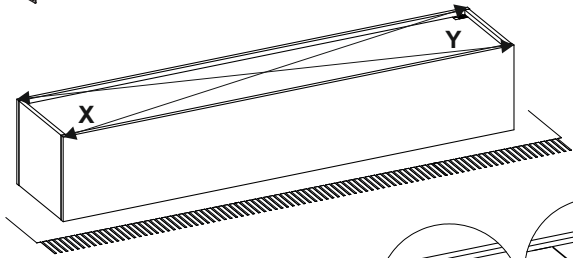

  $X=Y$   $\uparrow 90^\circ$

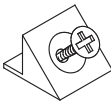

S1	
x6	

U13	
x3	UP $\varnothing 3 \times 20$

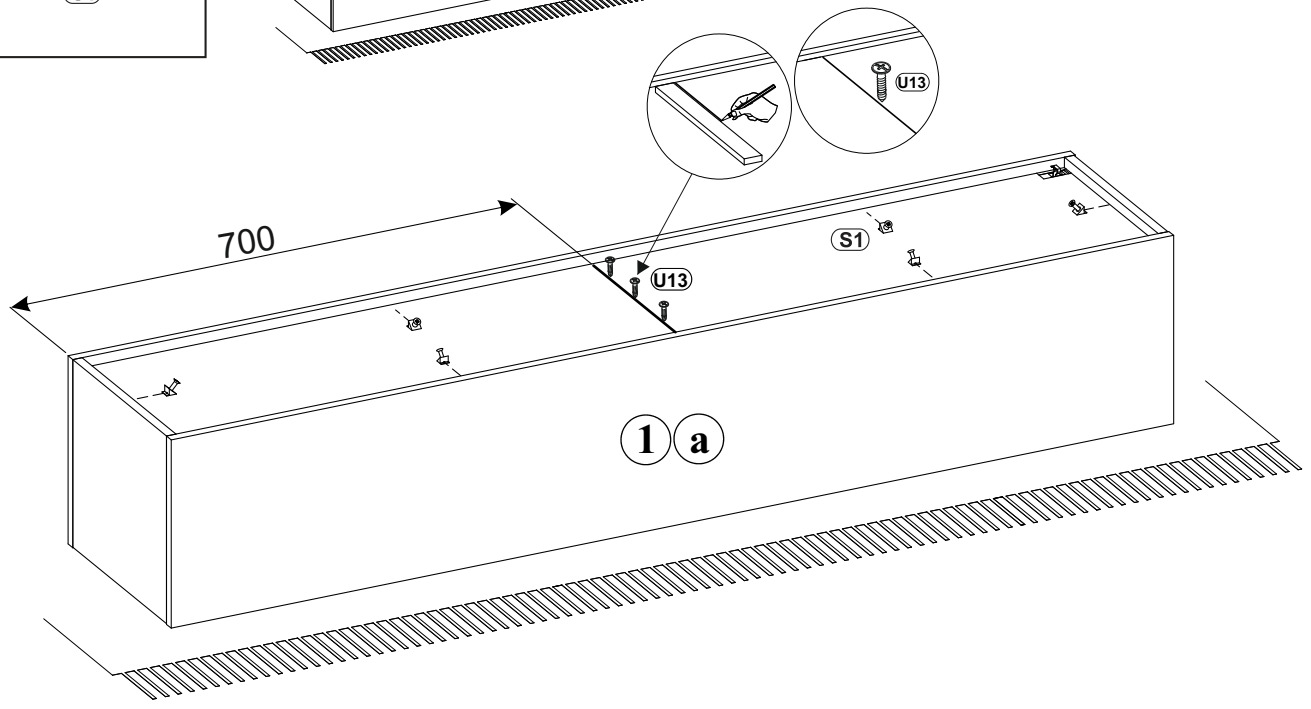



SZAFKA WYSOKA  
1 DRZWI 80-30-1D

8

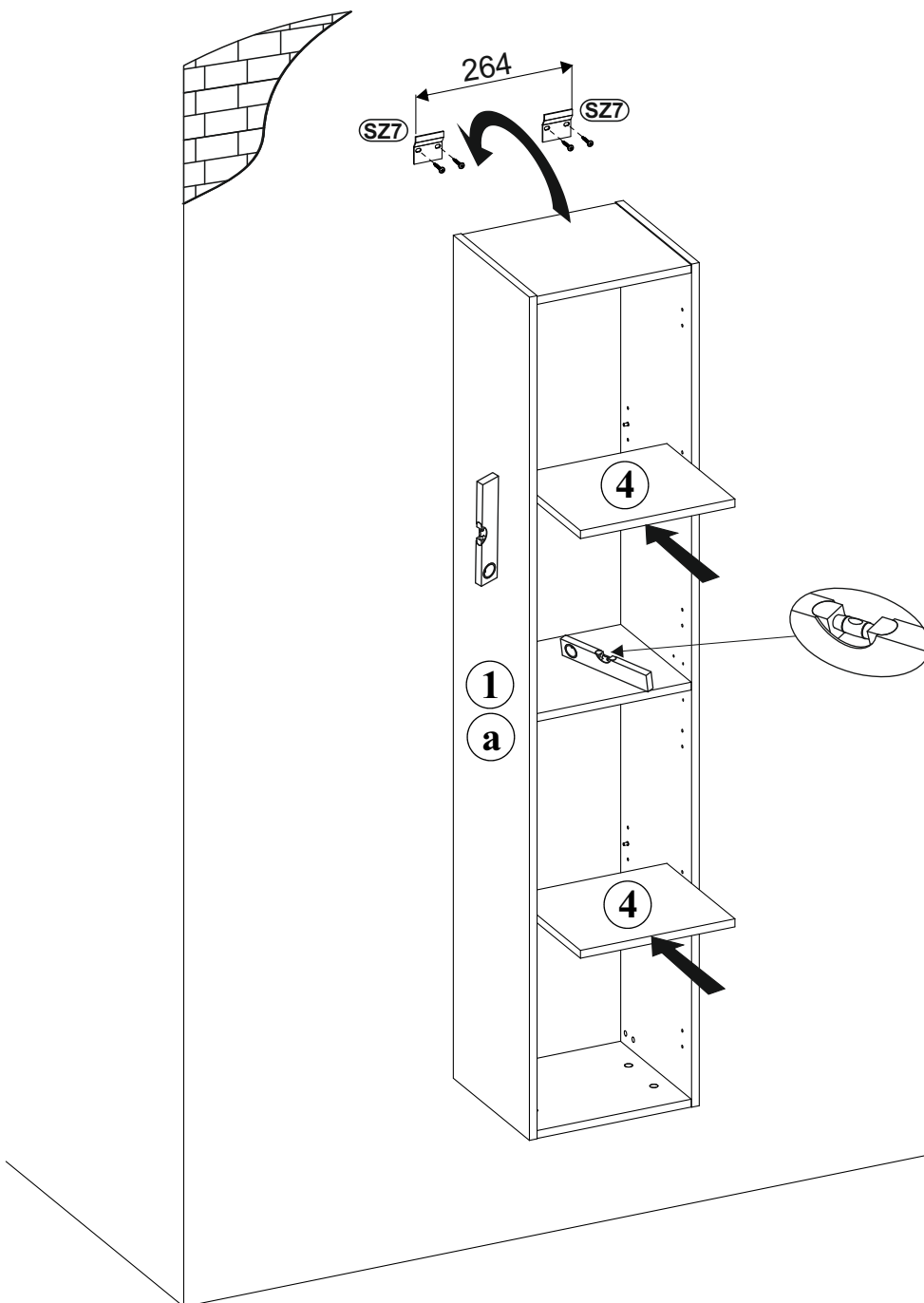
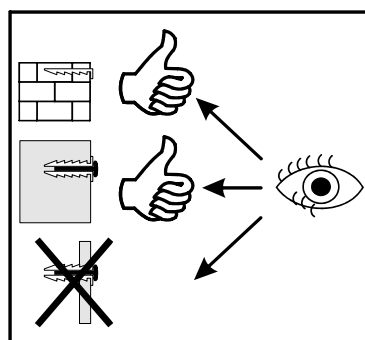
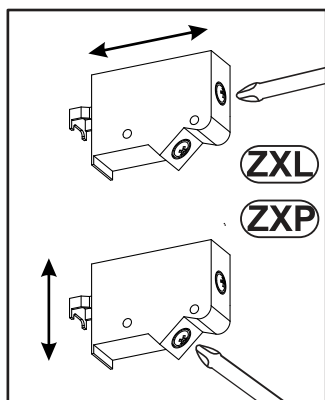
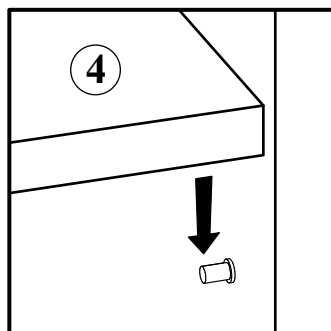
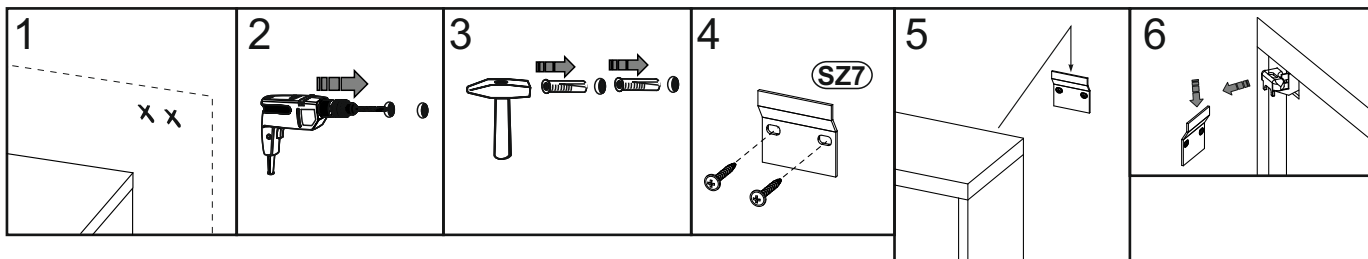
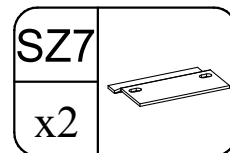
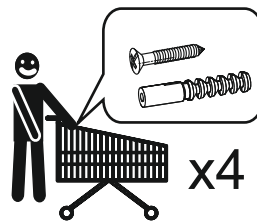

**SZAFKA WYSOKA  
1 DRZWI 80-30-1D**

**9**

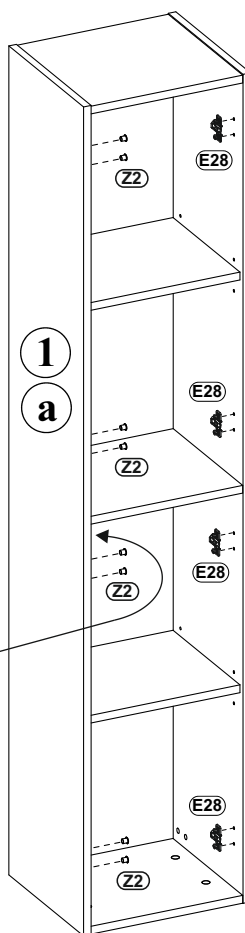
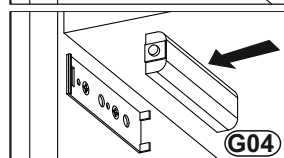
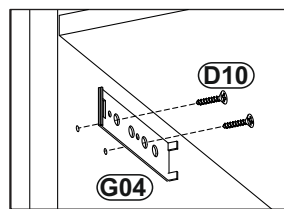
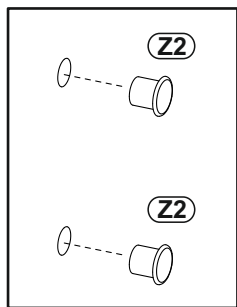
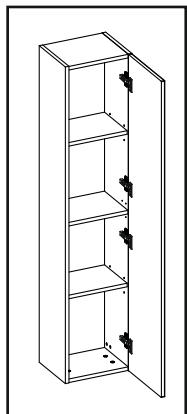

E28		Z2	
x4	H=0	x8	Ø5

D10		G04	
x2	USØ3,5x13	x1	

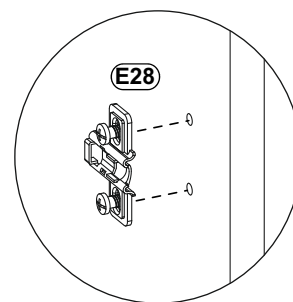

**10**

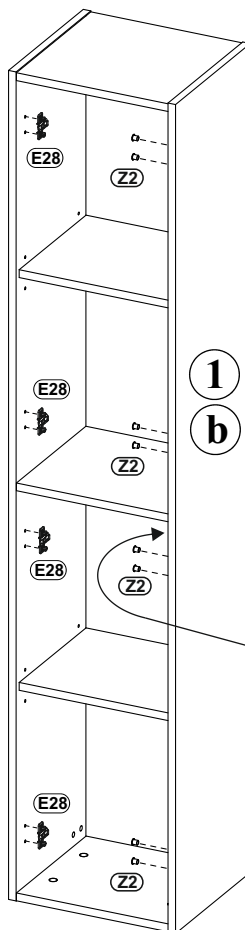
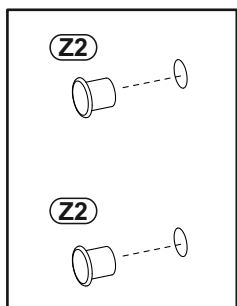
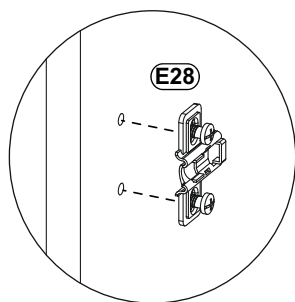
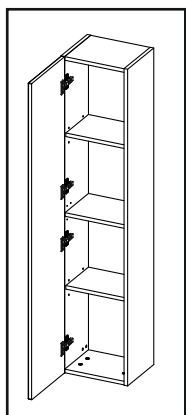

E28		Z2	
x4	H=0	x8	Ø5

D10		G04	
x2	USØ3,5x13	x1	

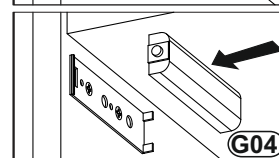
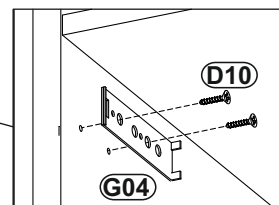

SZAFKA WYSOKA  
1 DRZWI 80-30-1D

11

