

BLAT 120 CM B1852, 89-120-B

SILIKON

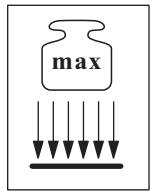

x2

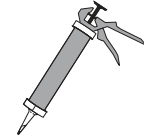
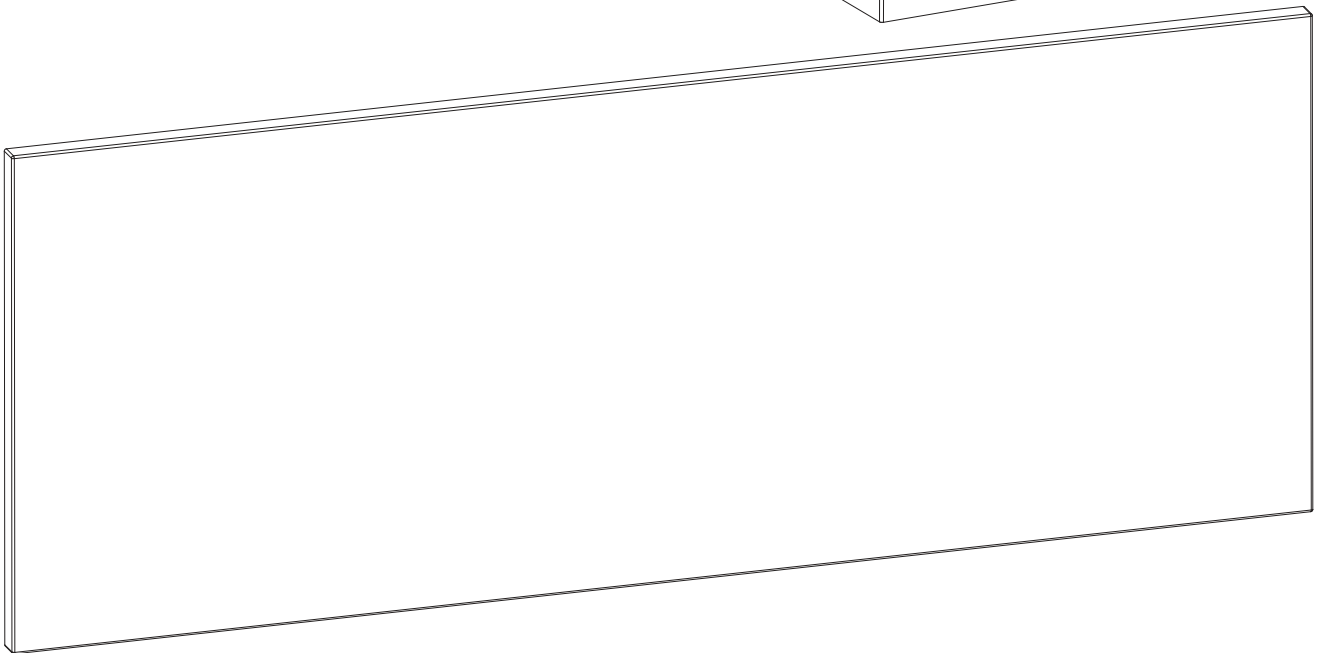
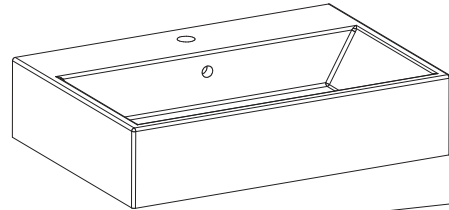

BLAT 120 CM B1854, 89-140-B

NO	Dim. [mm]		Col.-No	Qty
1	1202	462	25	1



90 min

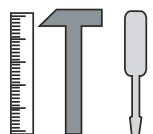
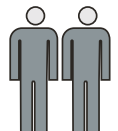

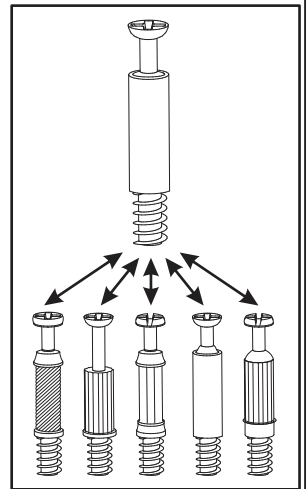
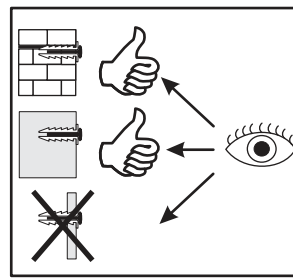
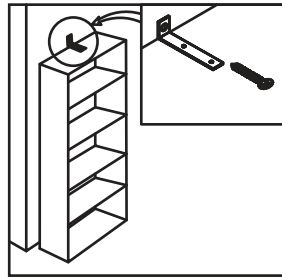
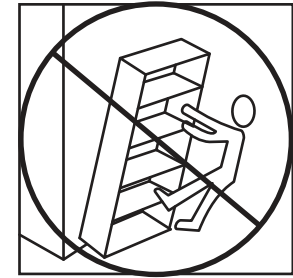
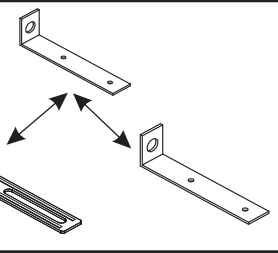
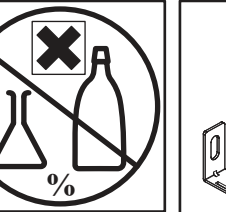
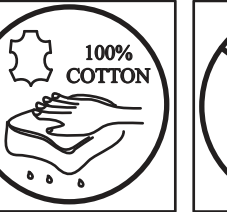
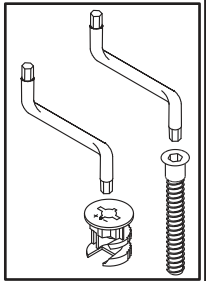
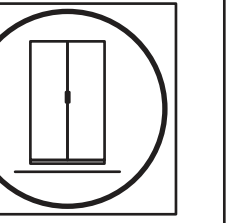
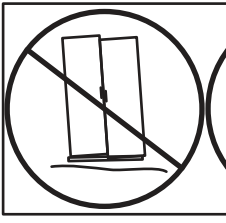
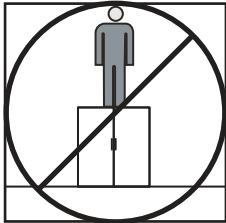
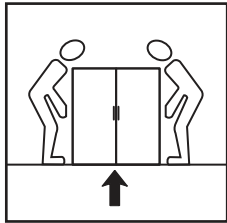
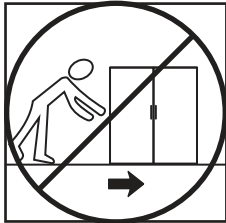
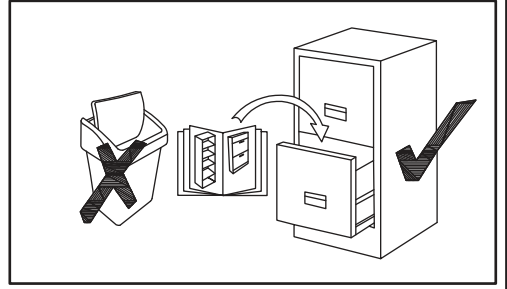
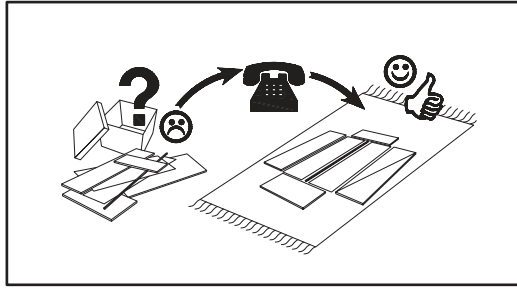
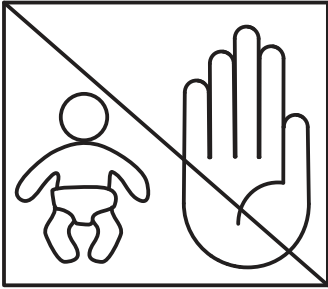
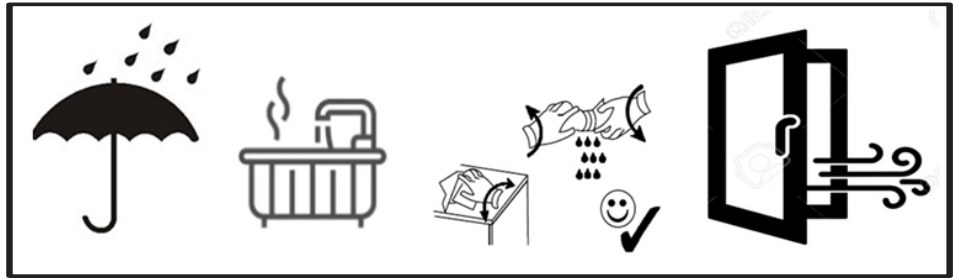
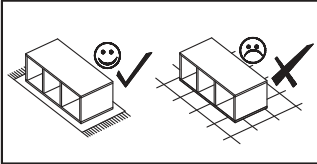
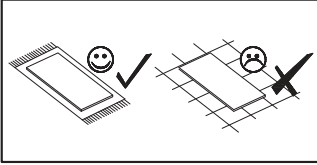

BLAT 120 CM BI852, 89-120-B

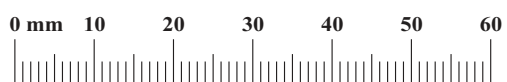
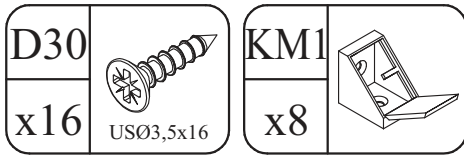

1

x2

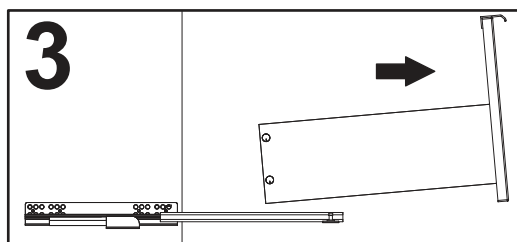
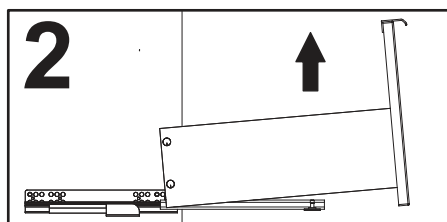
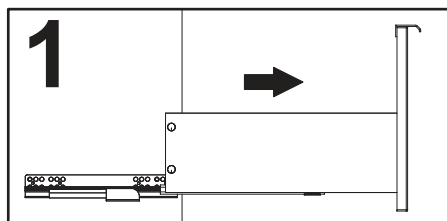
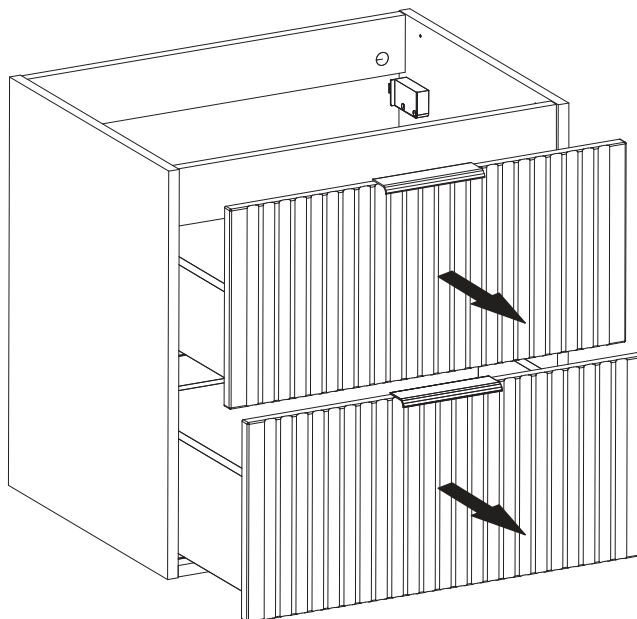

2

SZAFKA OTWARTA 81-__-A

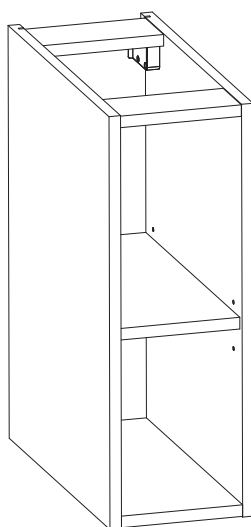

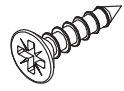
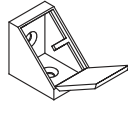
D30		KM1	
x8	USØ3,5x16	x8	

3

x2

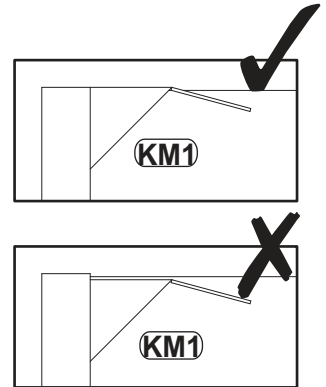
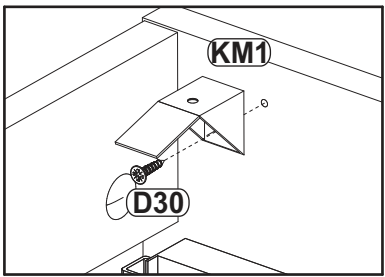
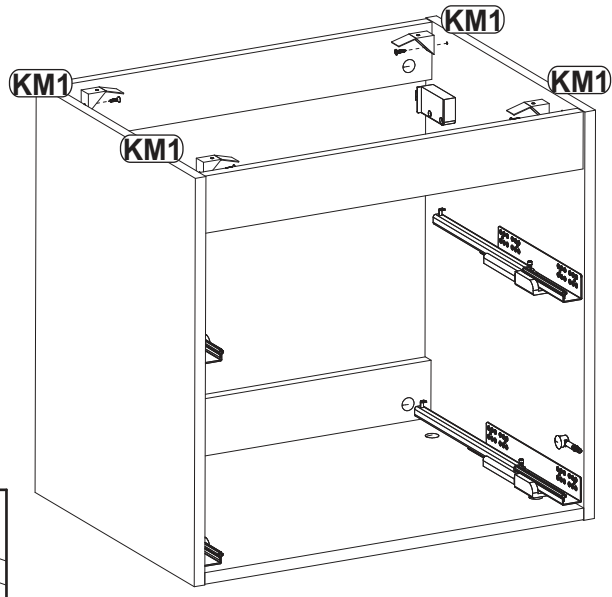

4

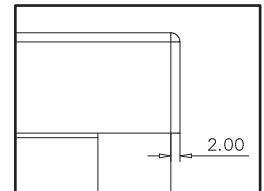
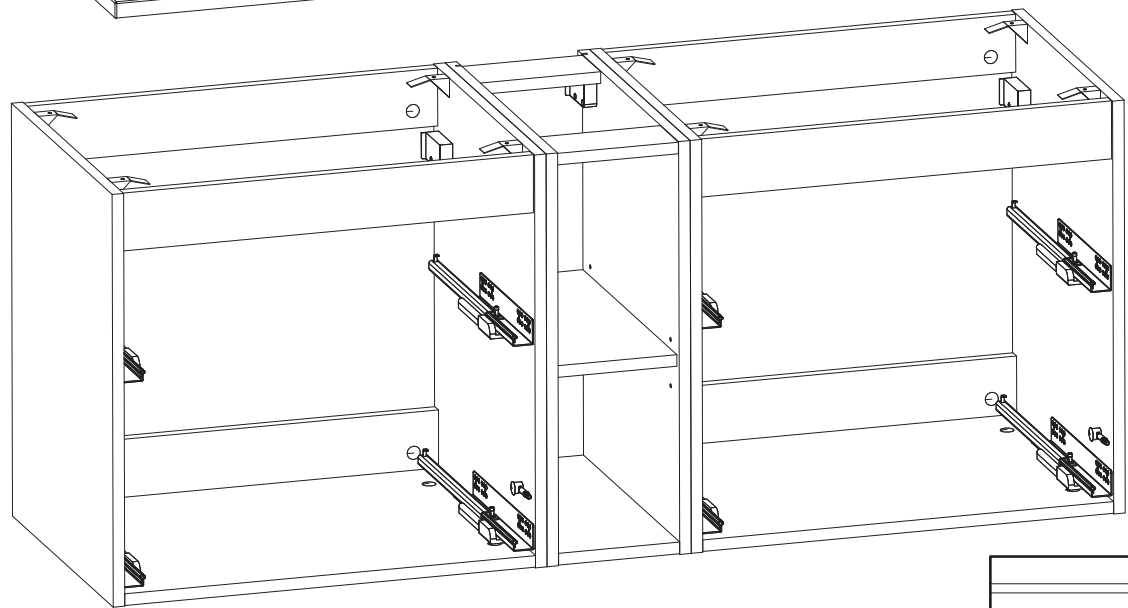
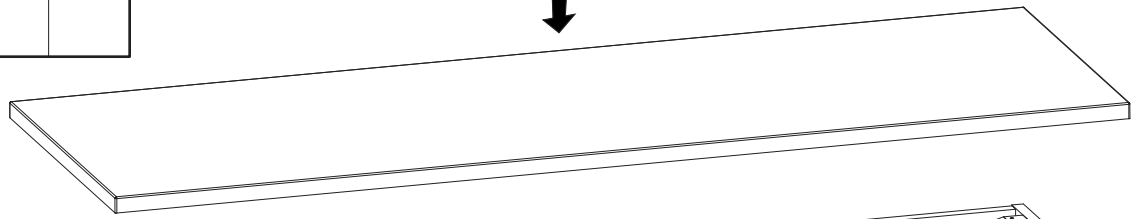
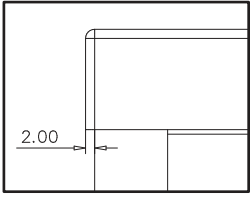

D30
x8
USØ3,5x16

5

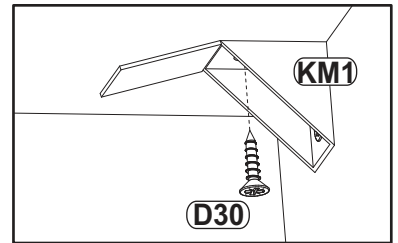
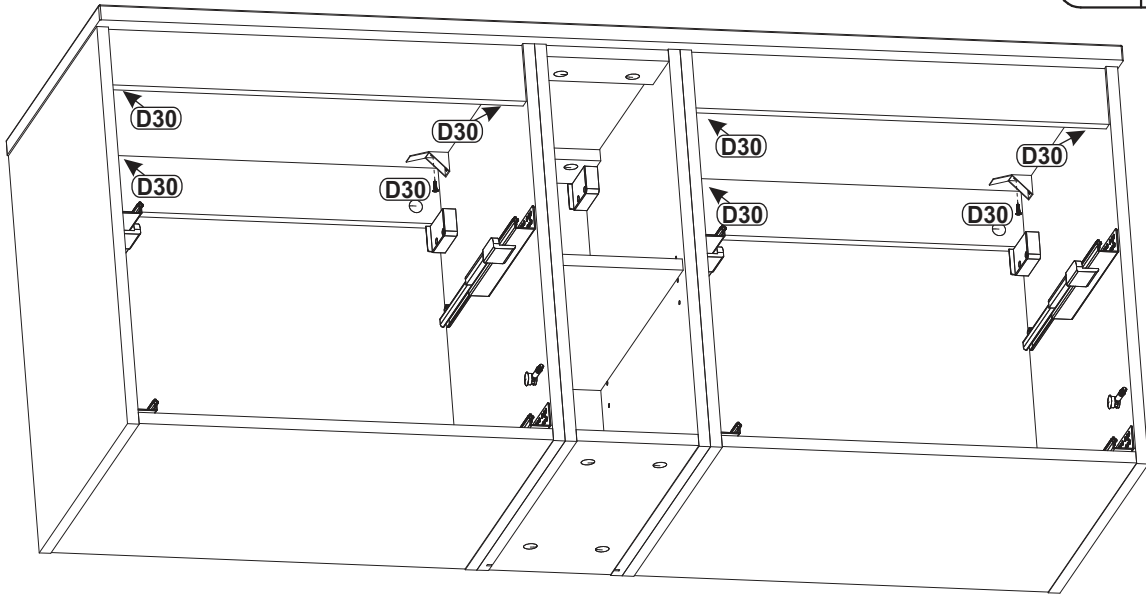

6

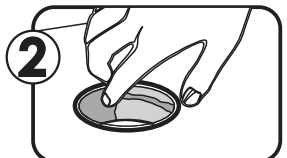
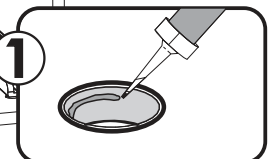
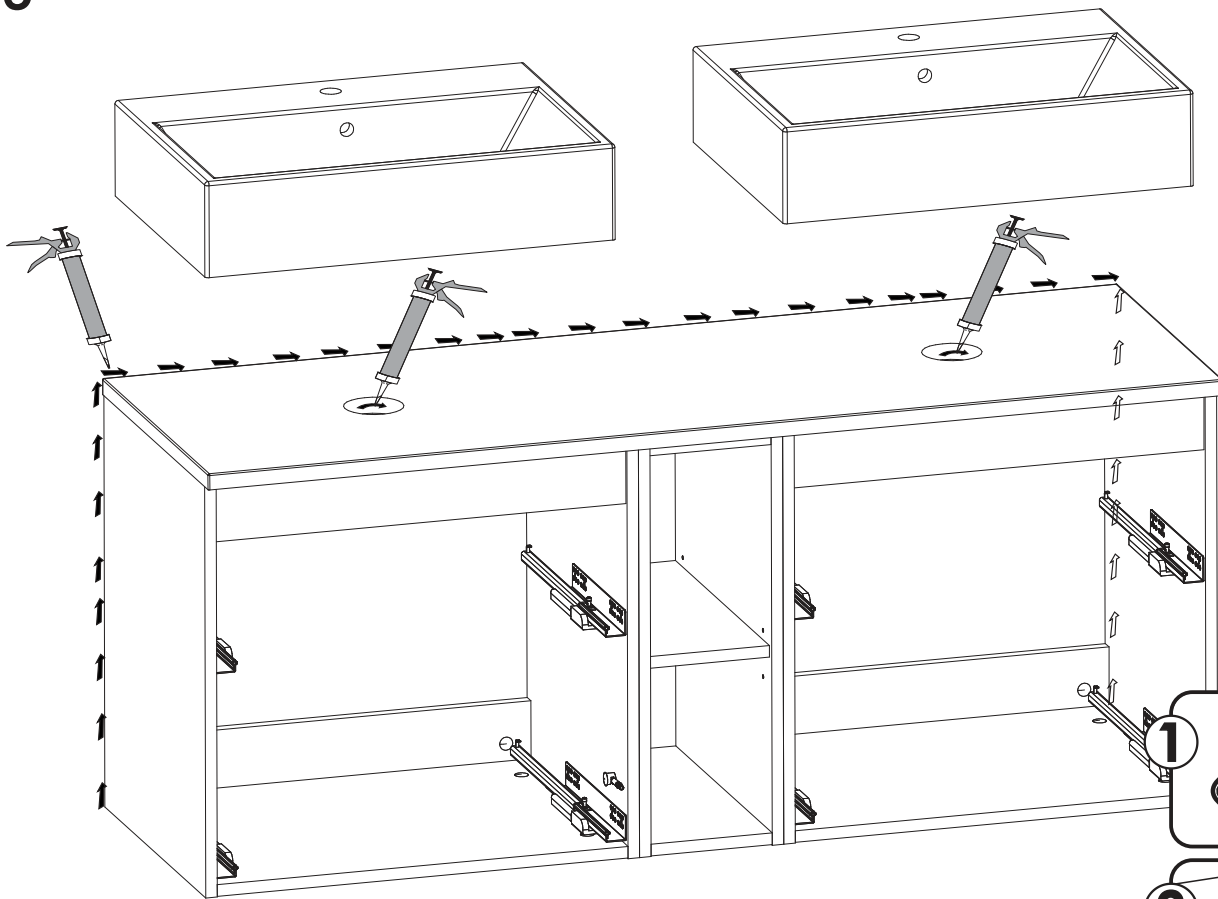

7

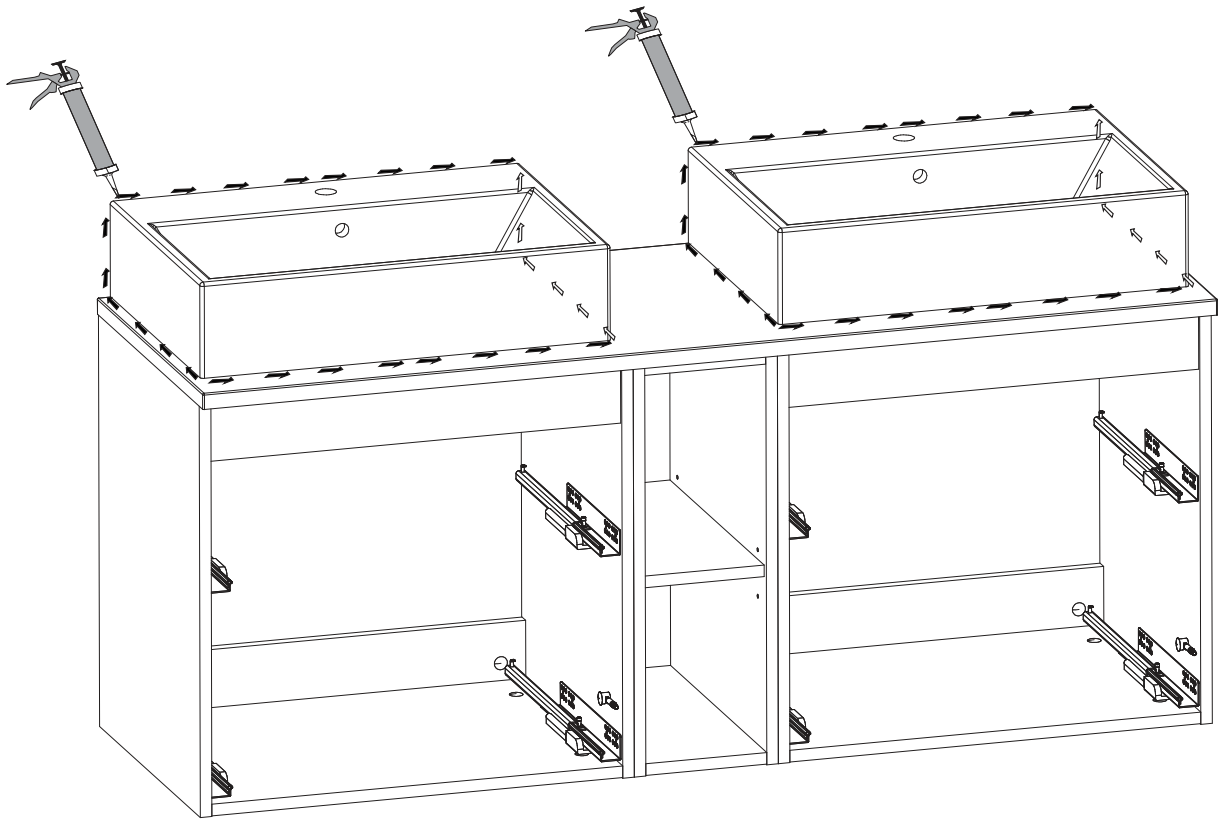

8

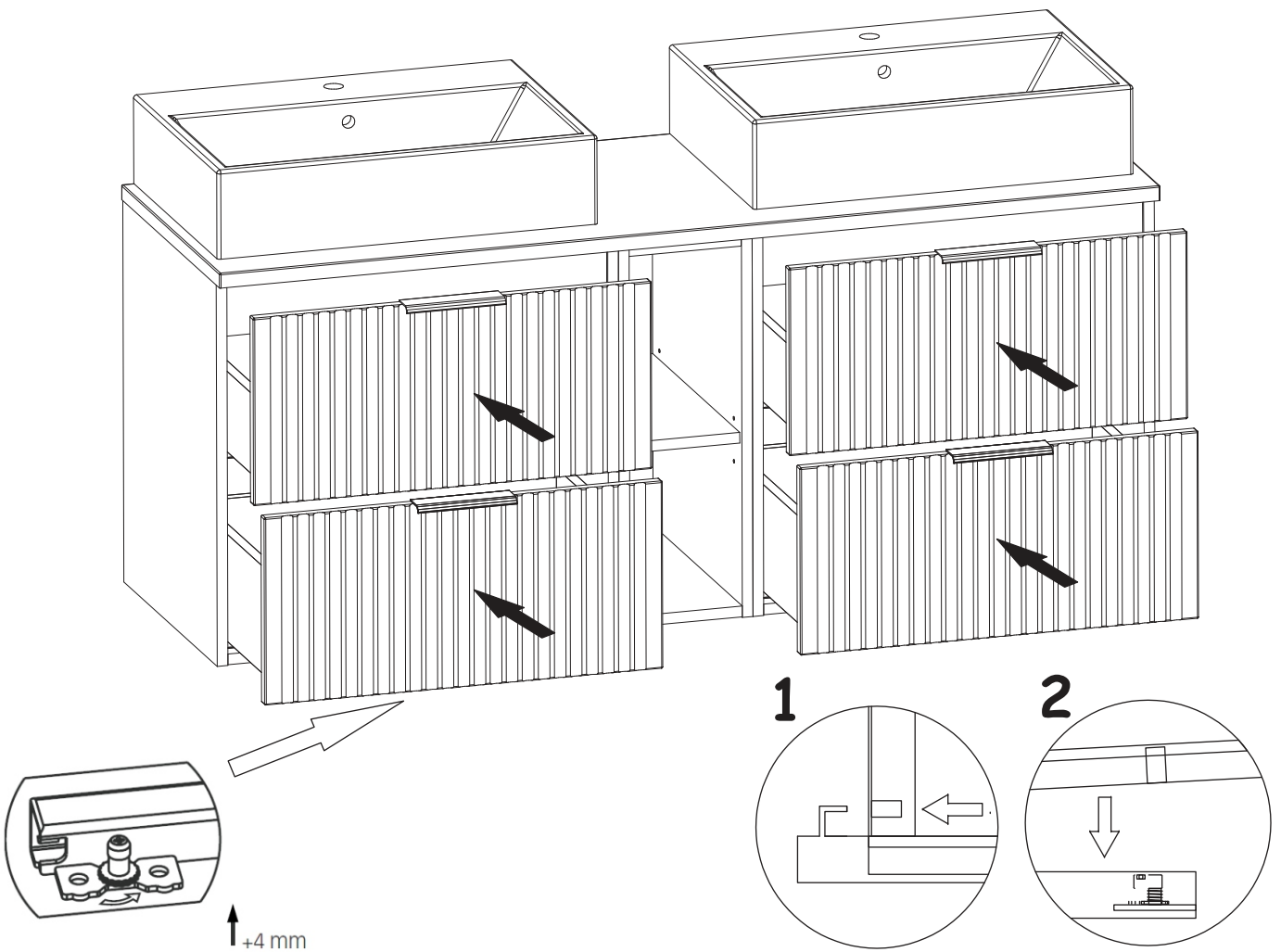

7

