

# WRAP

## R 105

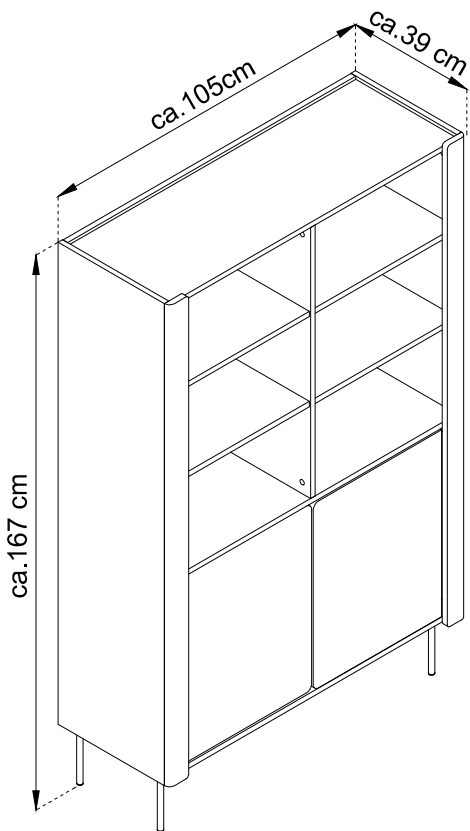

- (D) Montageanleitung
- (FR) Notice de montage
- (NL) Handleiding voor de montage
- (CZ) Montážní návod
- (HU) Szerelési útmutató
- (TR) Montaj talimati

- (GB) Assembly Instructions
- (IT) Istruzioni di montaggio
- (PL) Instrukcja montażu
- (SK) Návod na montáž
- (RO) Instrucțiuni de montaj
- (RU) Инструкции по монтажу

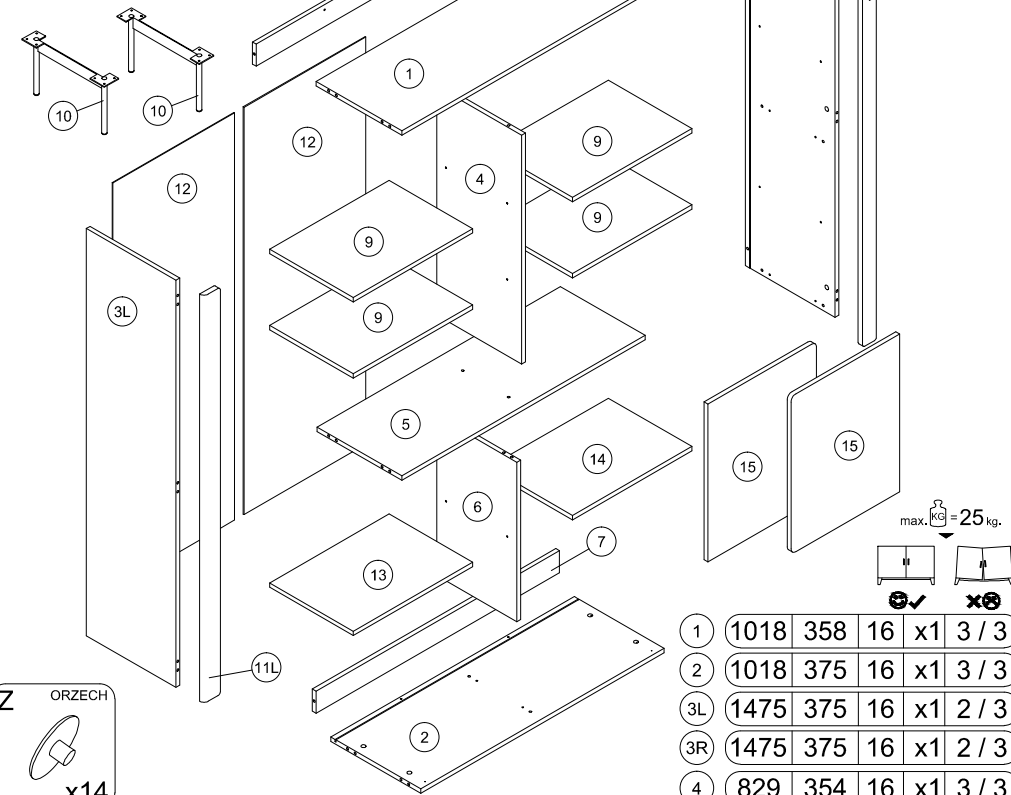
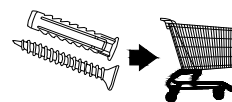
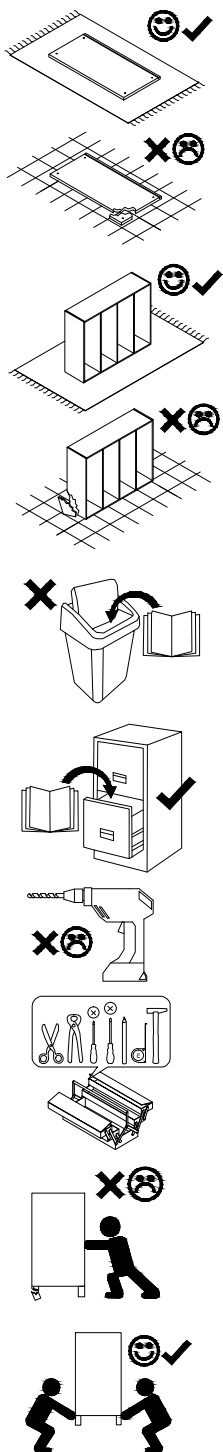

max. kg = 25 kg.

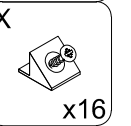
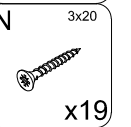
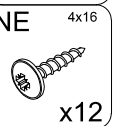
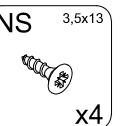
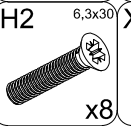
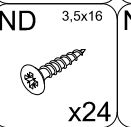
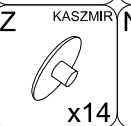
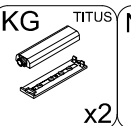
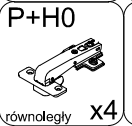
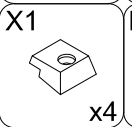
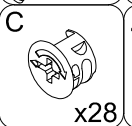
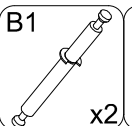
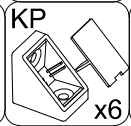
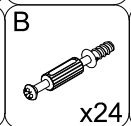
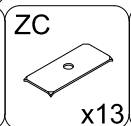
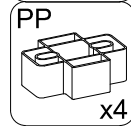
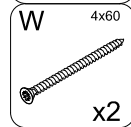
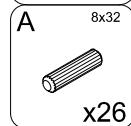
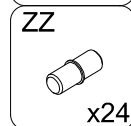

1	1018	358	16	x1	3 / 3
2	1018	375	16	x1	3 / 3
3L	1475	375	16	x1	2 / 3
3R	1475	375	16	x1	2 / 3
4	829	354	16	x1	3 / 3
5	1018	354	16	x1	3 / 3
6	578	334	16	x1	3 / 3
7	1018	80	16	x1	2 / 3
8	1018	80	16	x1	2 / 3
9	500	350	16	x4	3 / 3
10	344	200	60	x2	1 / 1
11L	1475	68	18	x1	2 / 3
11R	1475	68	18	x1	2 / 3
12	1404	515	2,5	x2	2 / 3
13	500	330	16	x1	2 / 3
14	500	330	16	x1	3 / 3
15	571	454	16	x2	2 / 3

20.03.2023

! **Uwaga • Upozornění • Achtung • Attention • Caution • Figyelem**  
**Attenzione • Opgelet • Внимание • Atenție • Upozornenie • Dikkat** !

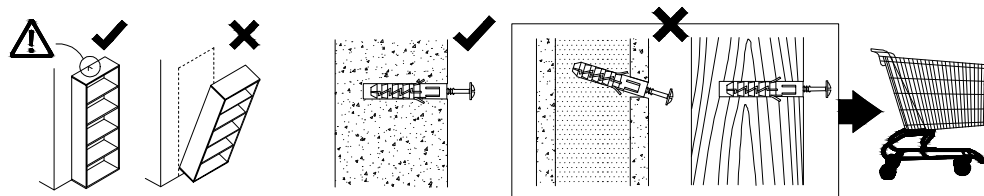
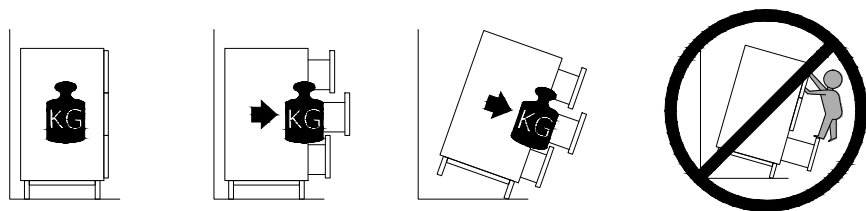

! **Uwaga • Upozornění • Achtung • Attention • Caution • Figyelem**  
**Attenzione • Opgelet • Внимание • Atenție • Upozornenie • Dikkat** !

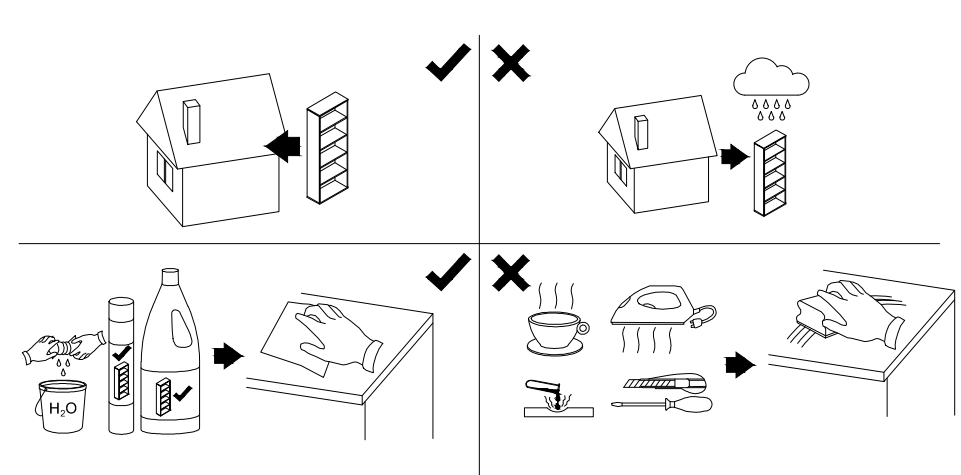

PL	Mocowanie do ściany jest jednocześnie zabezpieczeniem przed przewróceniem - koniecznie zamontować! Do niektórych rodzajów ścian koniecznie zastosować specjalne kolki mocujące.
CZ	Montáž na stěnu slouží jako ochrana proti převrnutí - bezpodmínečně umístěte! U některých typů stěn může být zapotřebí speciální hmoždinka!
DE	Wandbefestigung dient als Kippschutz - unbedingt anbringen! bei einigen Wandtypen kann ein Spezialdübel erforderlich sein!
GB	The wall fastening serves to prevent tipping - be absolutely sure to mount it! For certain wall types, a special wall plug may be necessary!
FR	La fixation murale sert de protection contre le basculement - à installer impérativement! Pour certains types de murs il faut des chevilles spéciales!
NL	De muurbevestiging is ook een anti-kantelbeveiliging - moet worden gemonteerd! Voor bepaalde soorten muren is het nodig speciale bevestigingspluggen te gebruiken.
IT	Il fissaggio alla parete serve da protezione anti-ribaltamento-attaccarla assolutamente! Per alcune strutture di parete può essere necessario un tassello speciale!
HU	A termék a falhoz kel rögzítési, különben az felborulhat! Egyes faltípusoknál speciális tiplít kell használni!
RU	Обязательно установите крепление на стене во избежание опрокидывания! Для некоторых типов стен может потребоваться специальный дюбель!
RO	Sistemul de fixare la perete servește ca protecție la răsturnare - de montat obligatoriu! Pentru unele tipuri de pereți este posibil să fie necesar un diblu special!
SK	Upevnenie na stenu slúži ako ochrana proti prevráteniu - bezpodmienečne použite! Pre niektoré druhy stien môže byť potrebná špeciálna hmoždinka!
TR	Duvardaki sabitleme, devrilmeye karşı bir emniyet tedbiridir ve mutlaka monte edilmelidir! Bazı duvar tiplerinde bunun için özel bir dübel gerekli olabilir!

PL	Czyszczenie należy wykonać wyłącznie za pomocą ściereczki lub lekko nawilżonego ręcznika. Nie stosować środków czyszczących do szorowania.
CZ	Čistění je nutné vykonávat výhradně pomocí utěrky nebo lehce navlženého ručníku. Nepoužívejte čističe obsahující abrazivní částice.
DE	Bitte nur mit einem Staubtuch oder leicht feuchtern Lappen reinigen. Keine scheuernden Putzmittel verwenden.
GB	Please only clean with a duster or damp cloth. Do not use any abrasive cleaners.
FR	Le nettoyage se fait uniquement à l'aide d'un torchon ou d'une serviette légèrement mouillée.
NL	Reinigen met een zachte doek of een licht vochtige doek. Geen schurende middelen gebruiken.
IT	Pulire esclusivamente con un panno o un asciugamano umido.
HU	A tisztítás kizárólag törleruha vagy enyhén nedvesített törölköző segítségével végezhető. Súroló hatású tisztítószerket nem szabad használni.
RU	Очищайте от пыли тряпкой или слегка влажной ветошью. Не допускается применение чистящих средств, не предназначенных для ухода за мебелью.
RO	Curățarea trebuie efectuată numai cu o cârpă sau cu un prosop ușor umezit. Nu utilizați agenți de curățare abrazivi.
SK	Čistenie je nutné vykonávať výhradne pomocou utierky alebo ľahko zvlhnutým ručníkom. Nepoužívajte čistiace prostriedky obsahujúce abrazívne častice.
TR	Lütfen sadece bir toz bezilye veya hafif nemli yumuşak bir bezle siliniz. Aşındırıcı temizlik malzemeleri kullanmayınız.

1

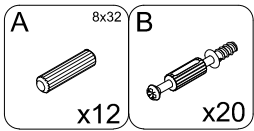
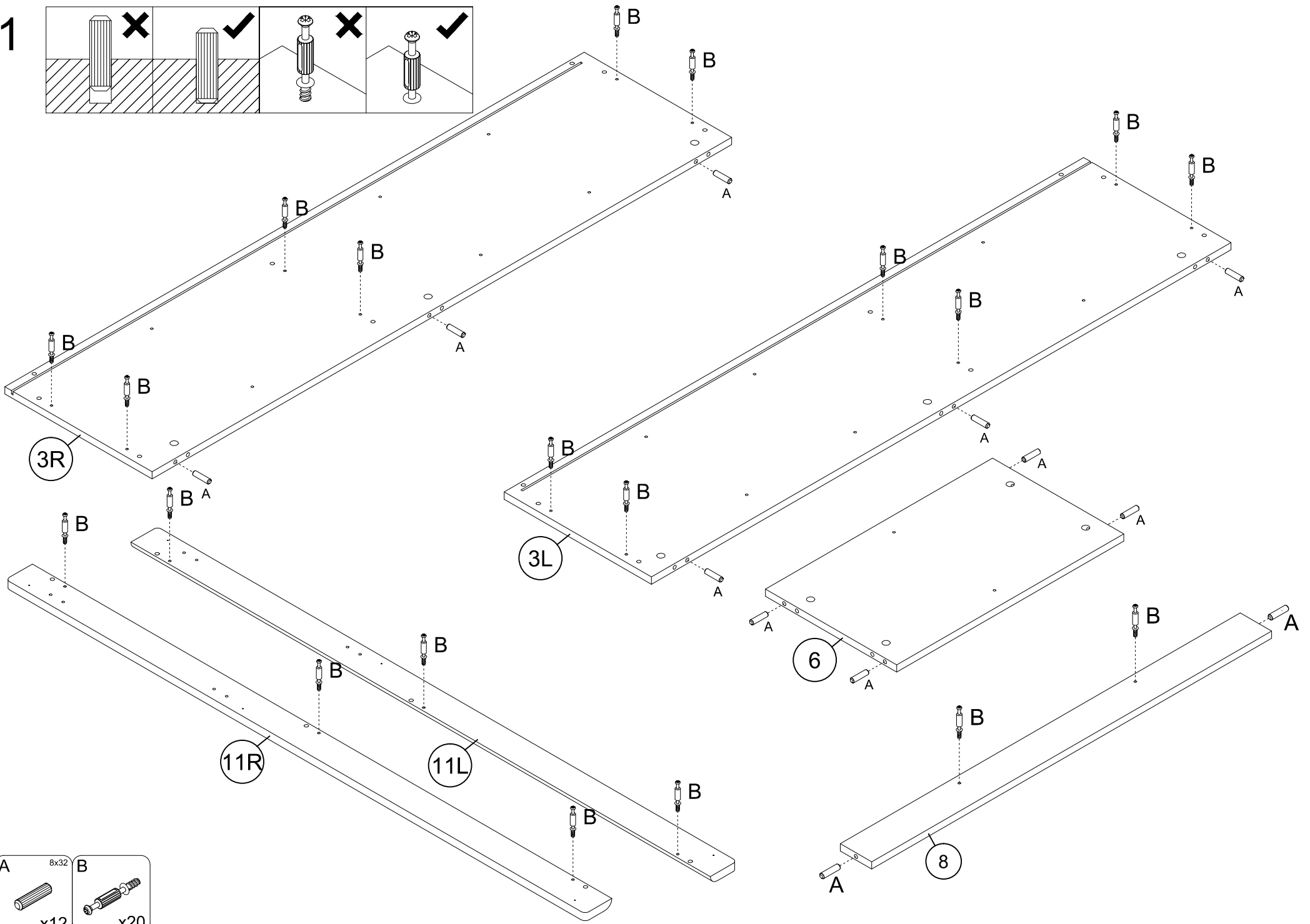
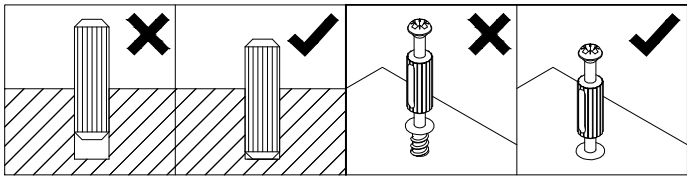

2

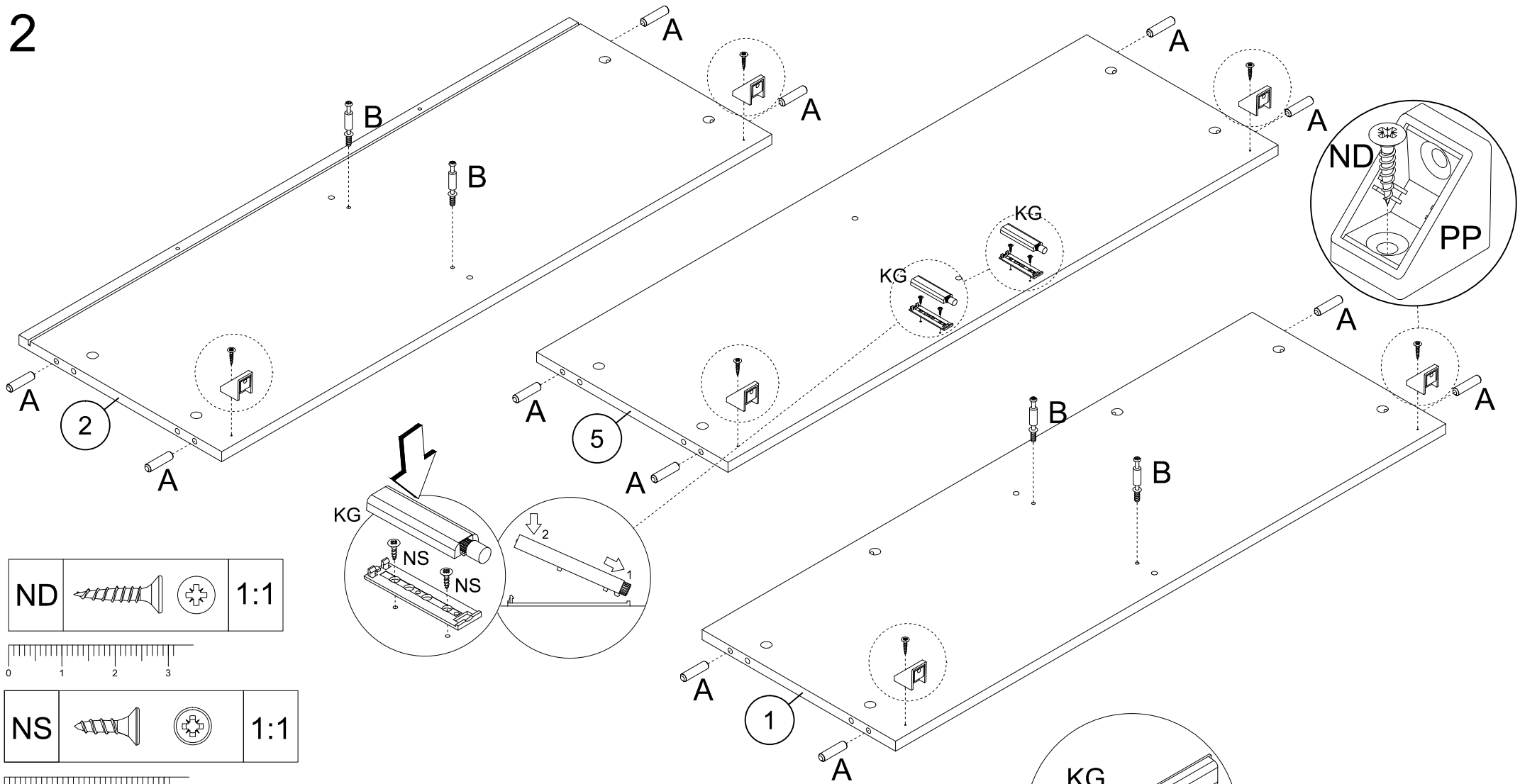

ND			1:1
----	--	--	-----

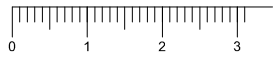

NS			1:1
----	--	--	-----

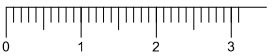

NS	3,5x13	KG	TITUS
	x4		x2

A	8x32	B	ND	3,5x16	KP		
	x12		x4		x6		x6

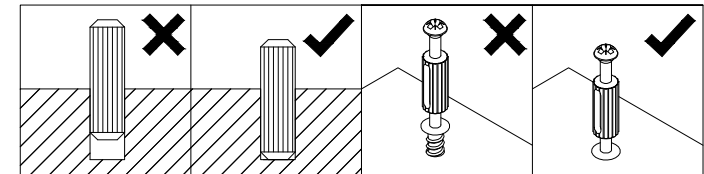
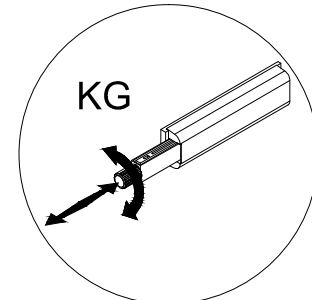
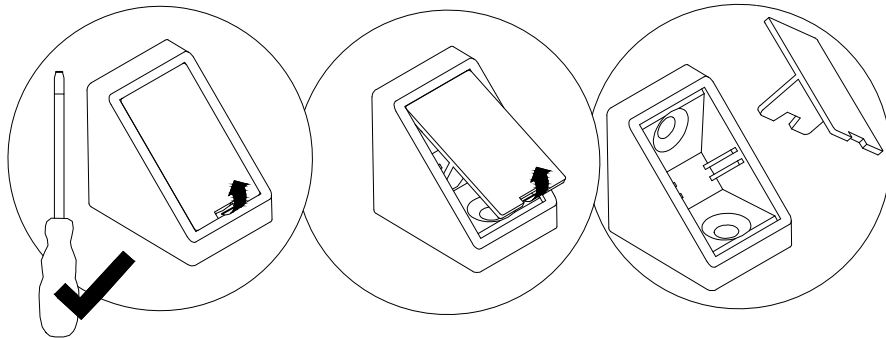

3

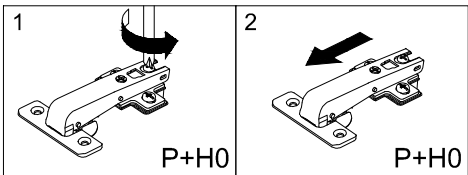

4

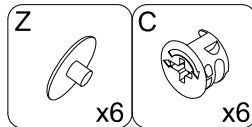
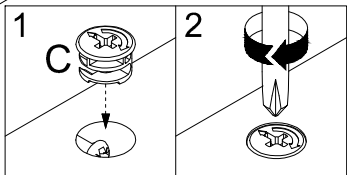
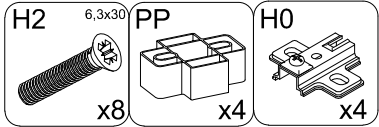
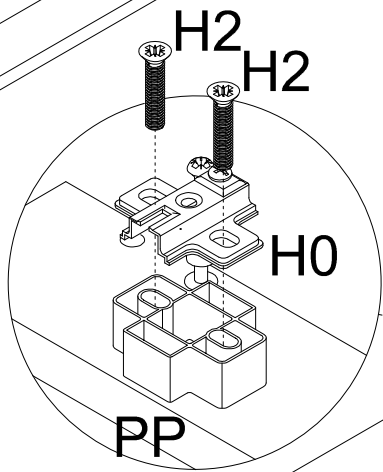
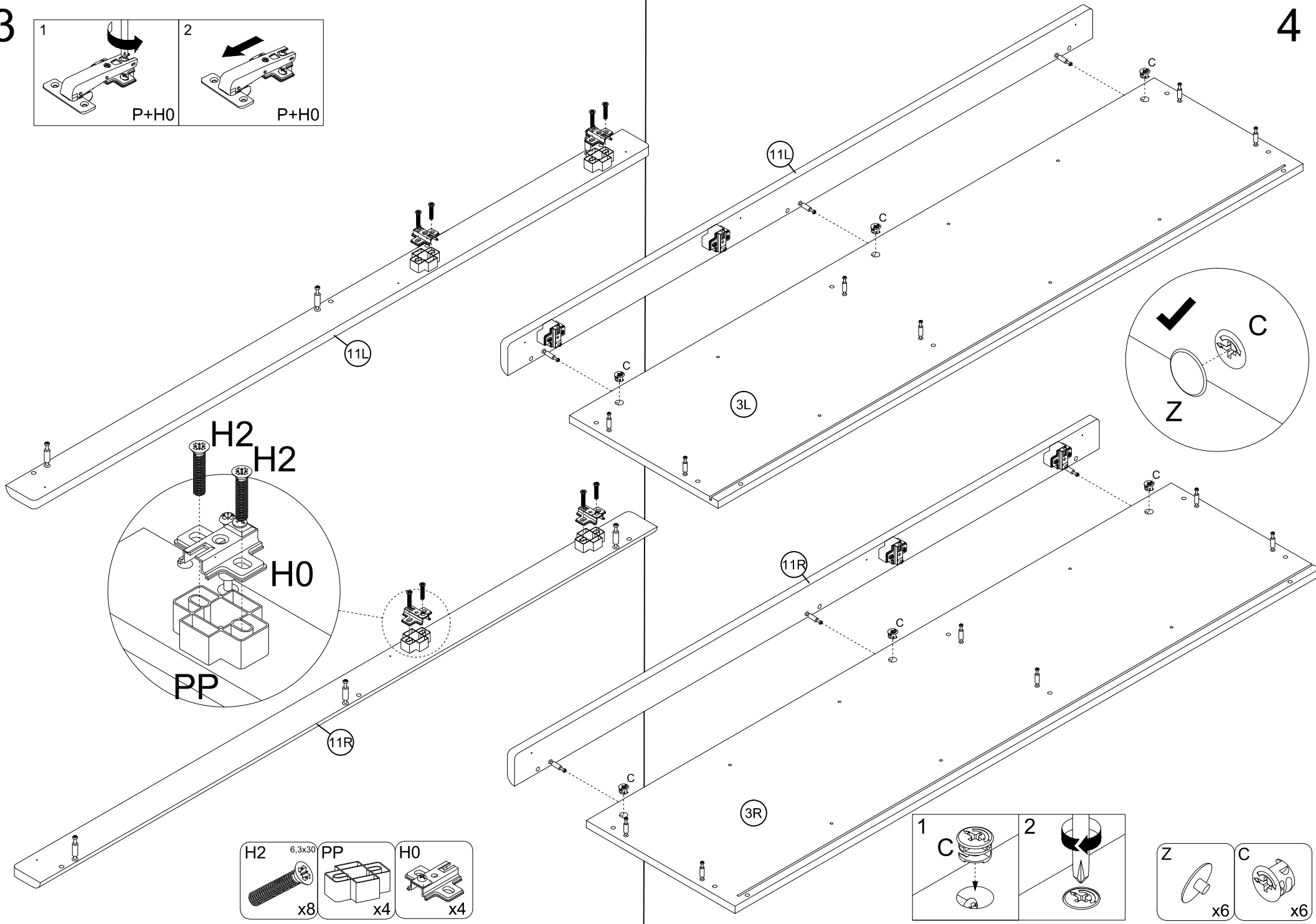

5

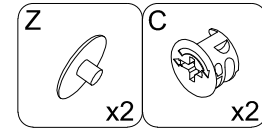
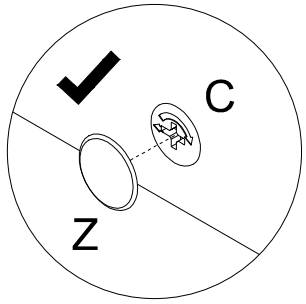
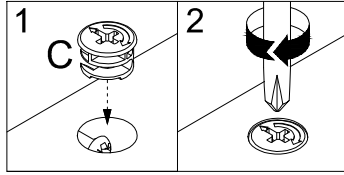

6

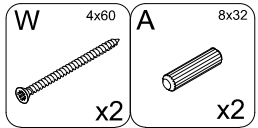
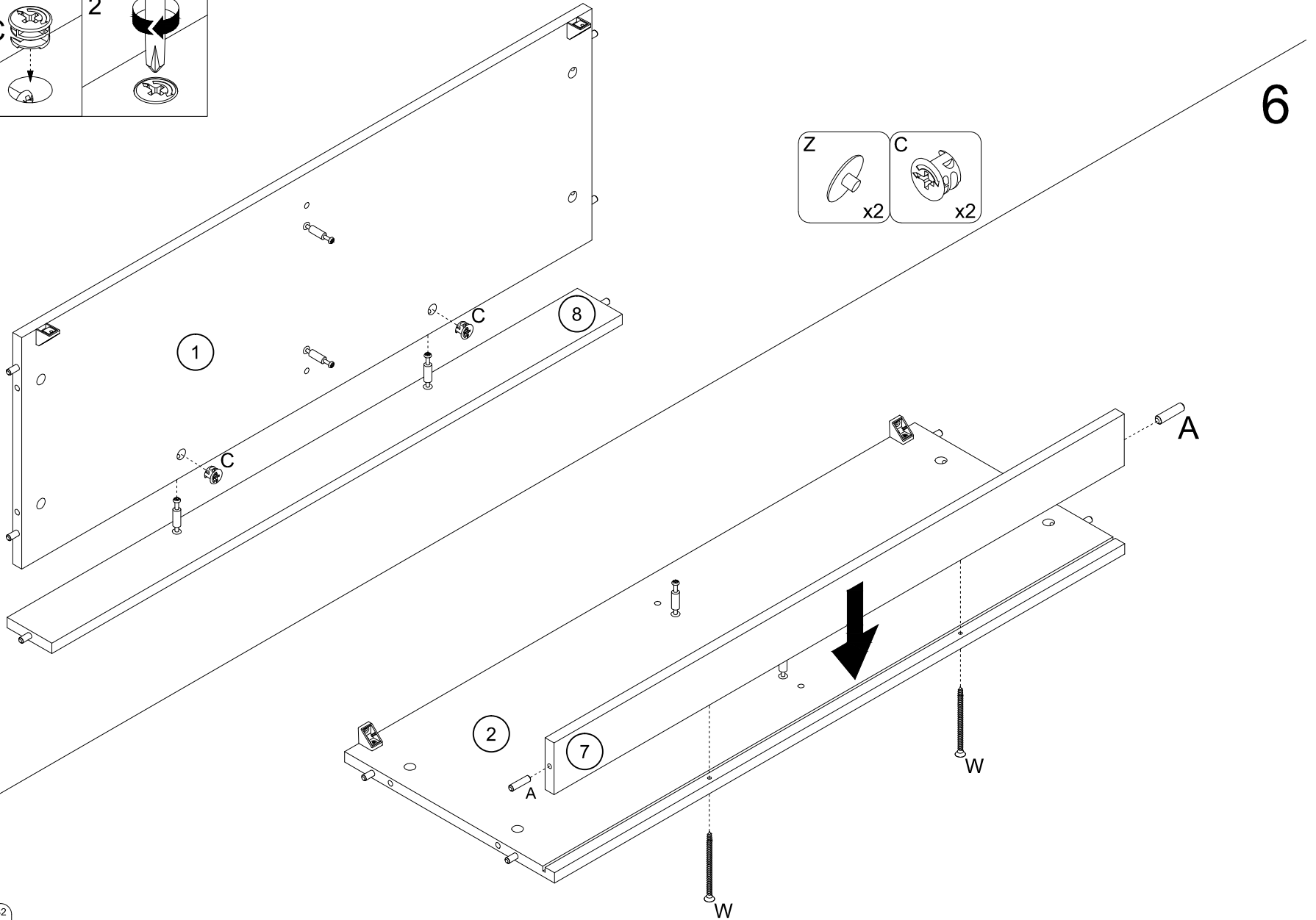

7

8

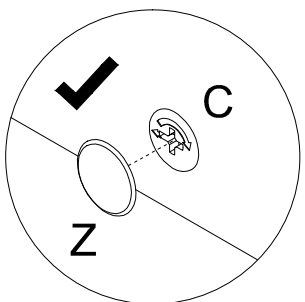
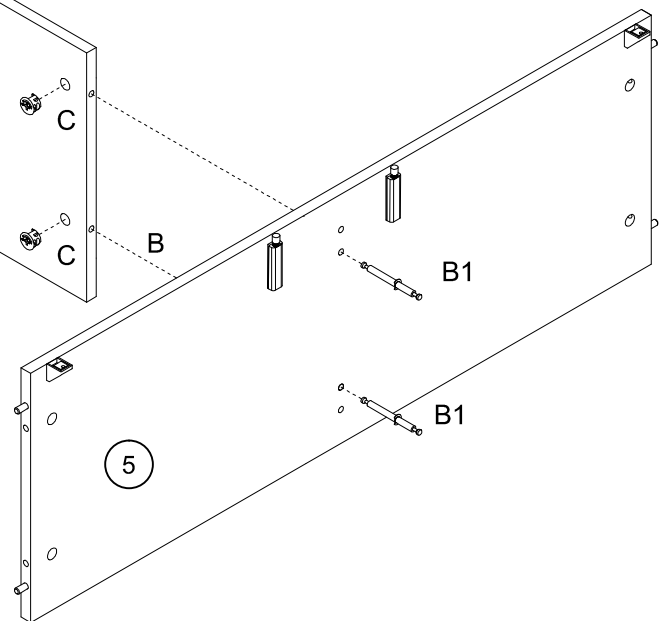
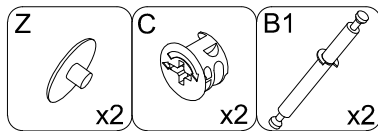
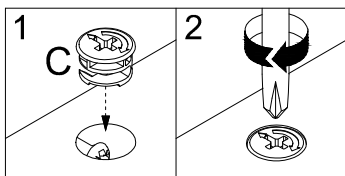
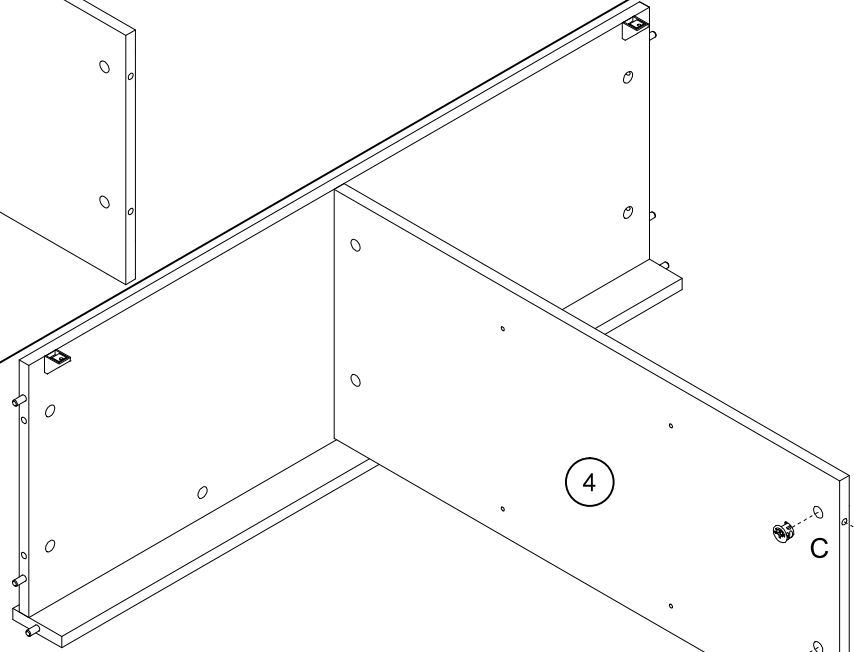
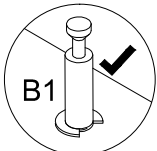
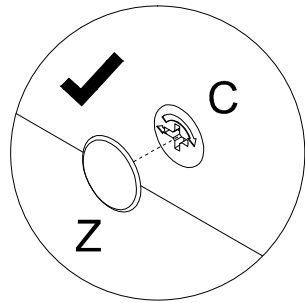
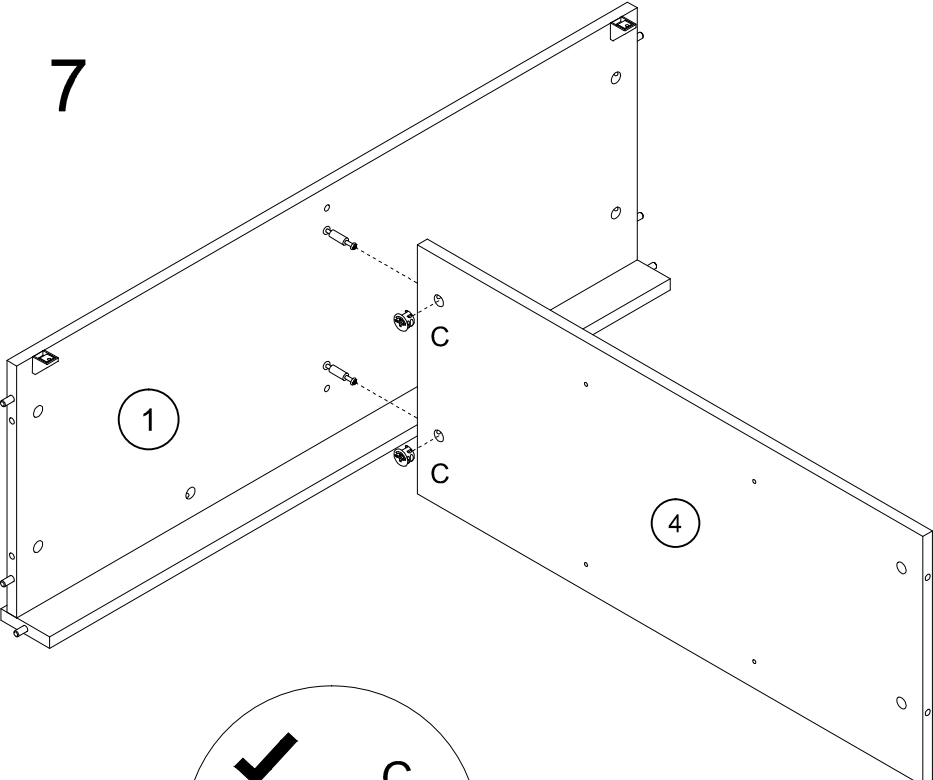
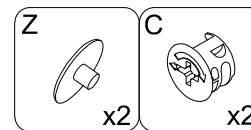
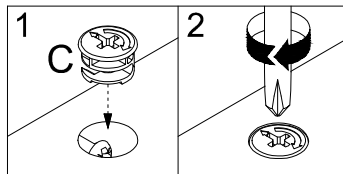

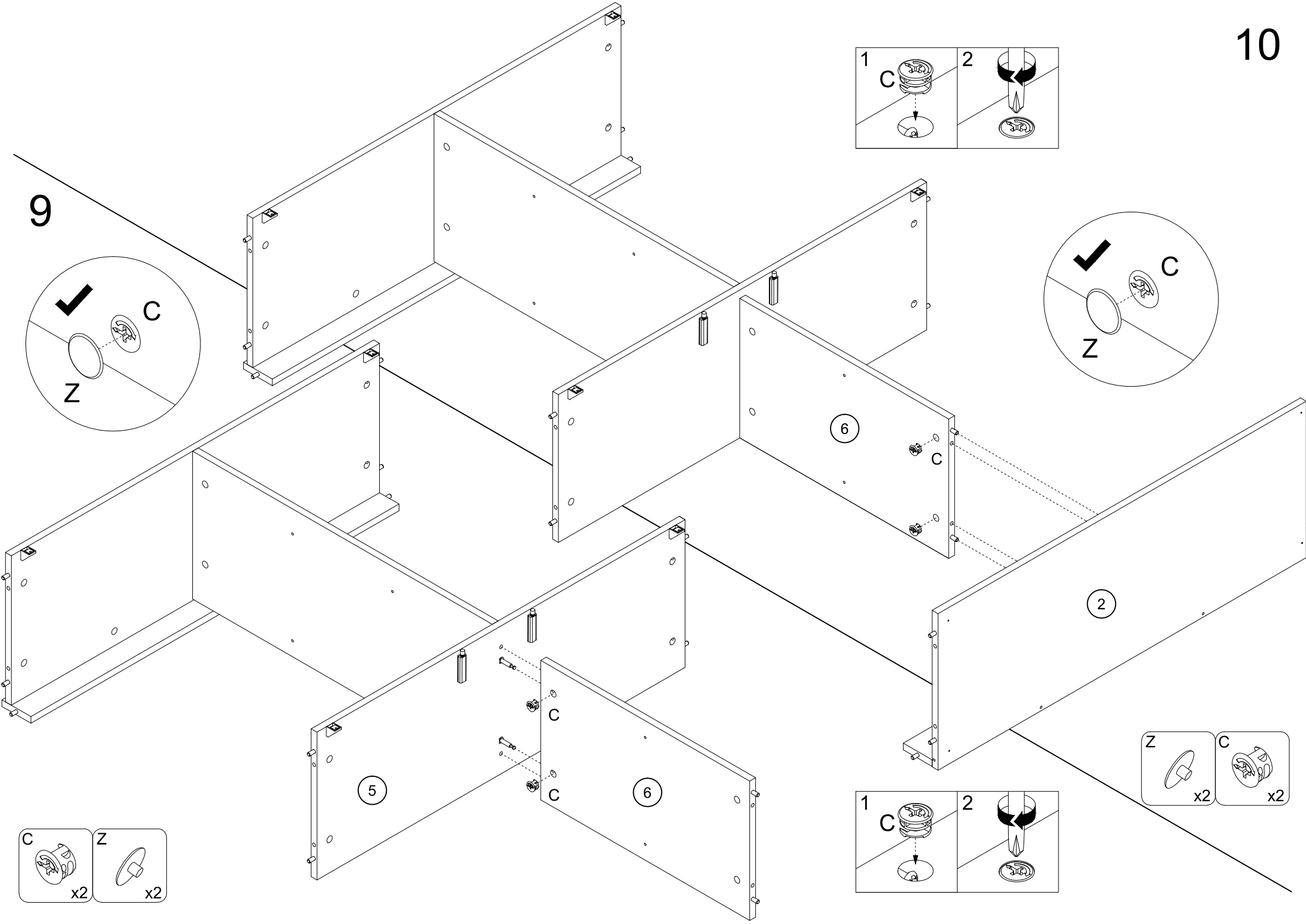

9

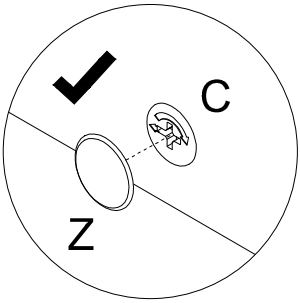
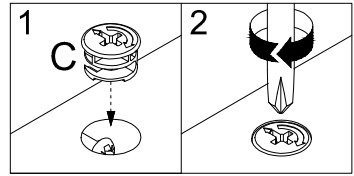
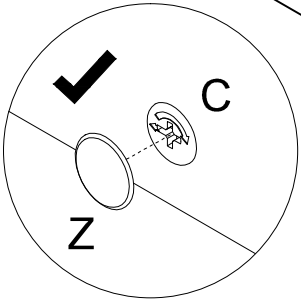

6

2

5

6

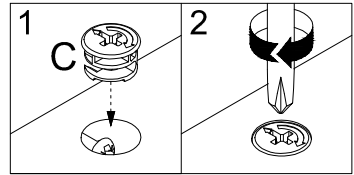
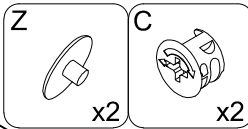
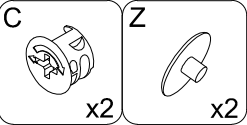



11

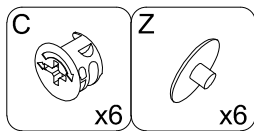
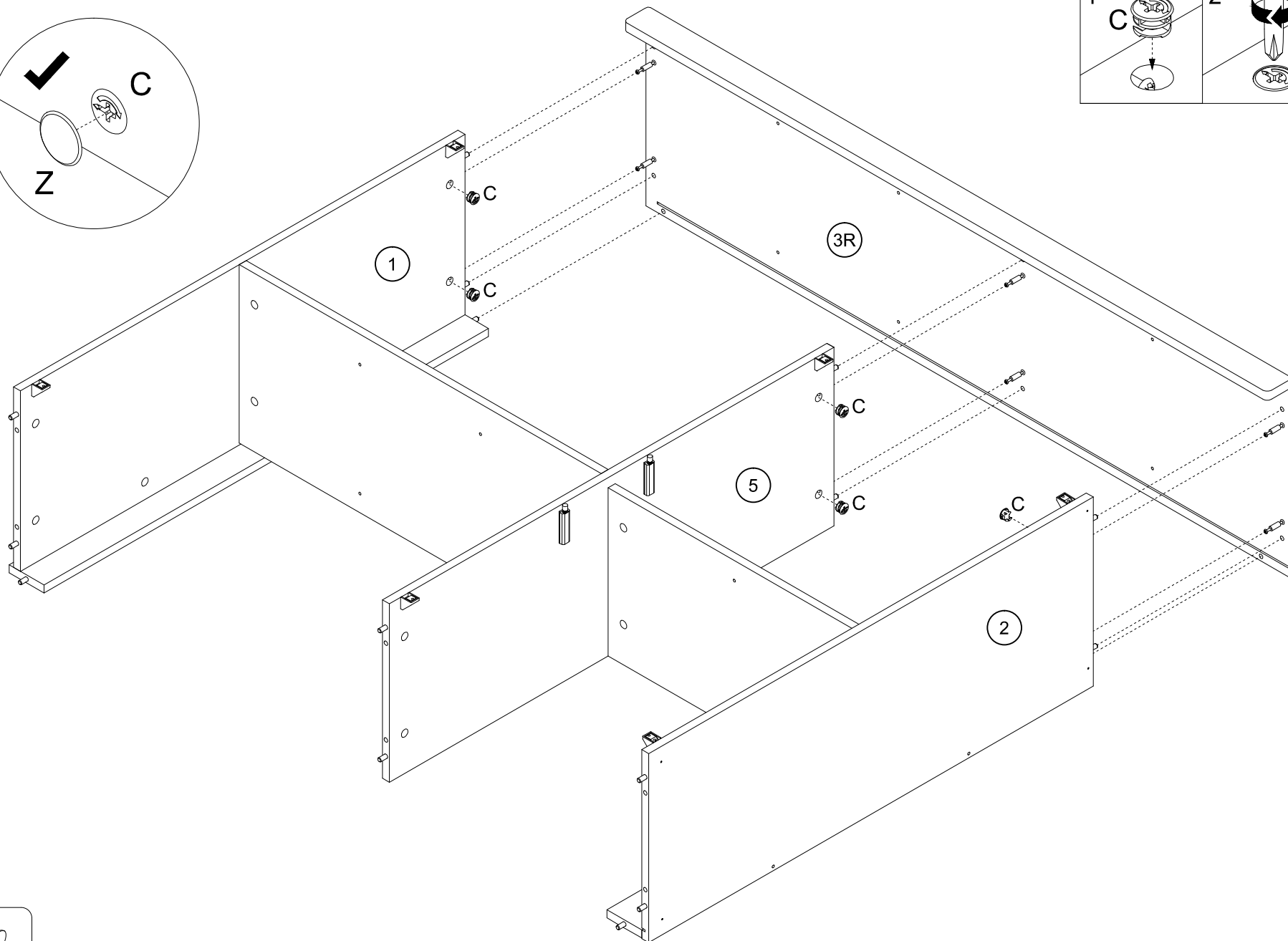
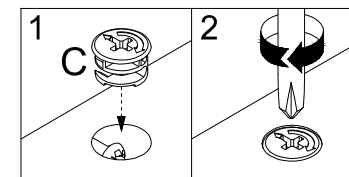
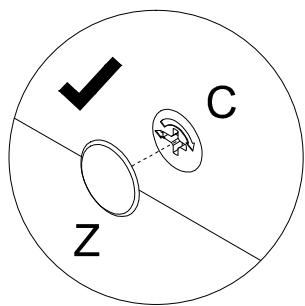

12

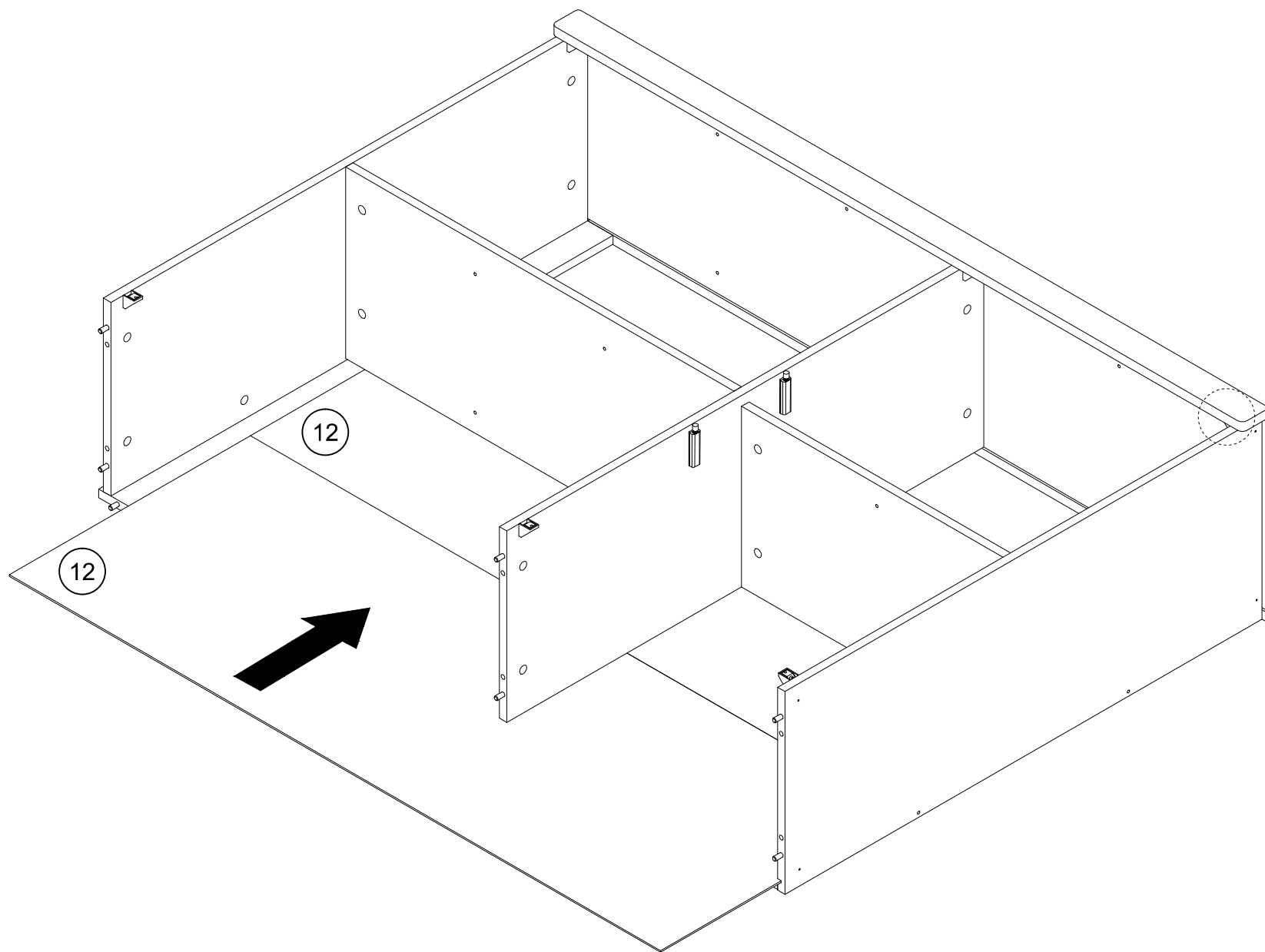

13

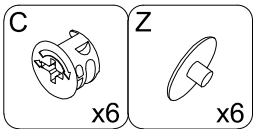
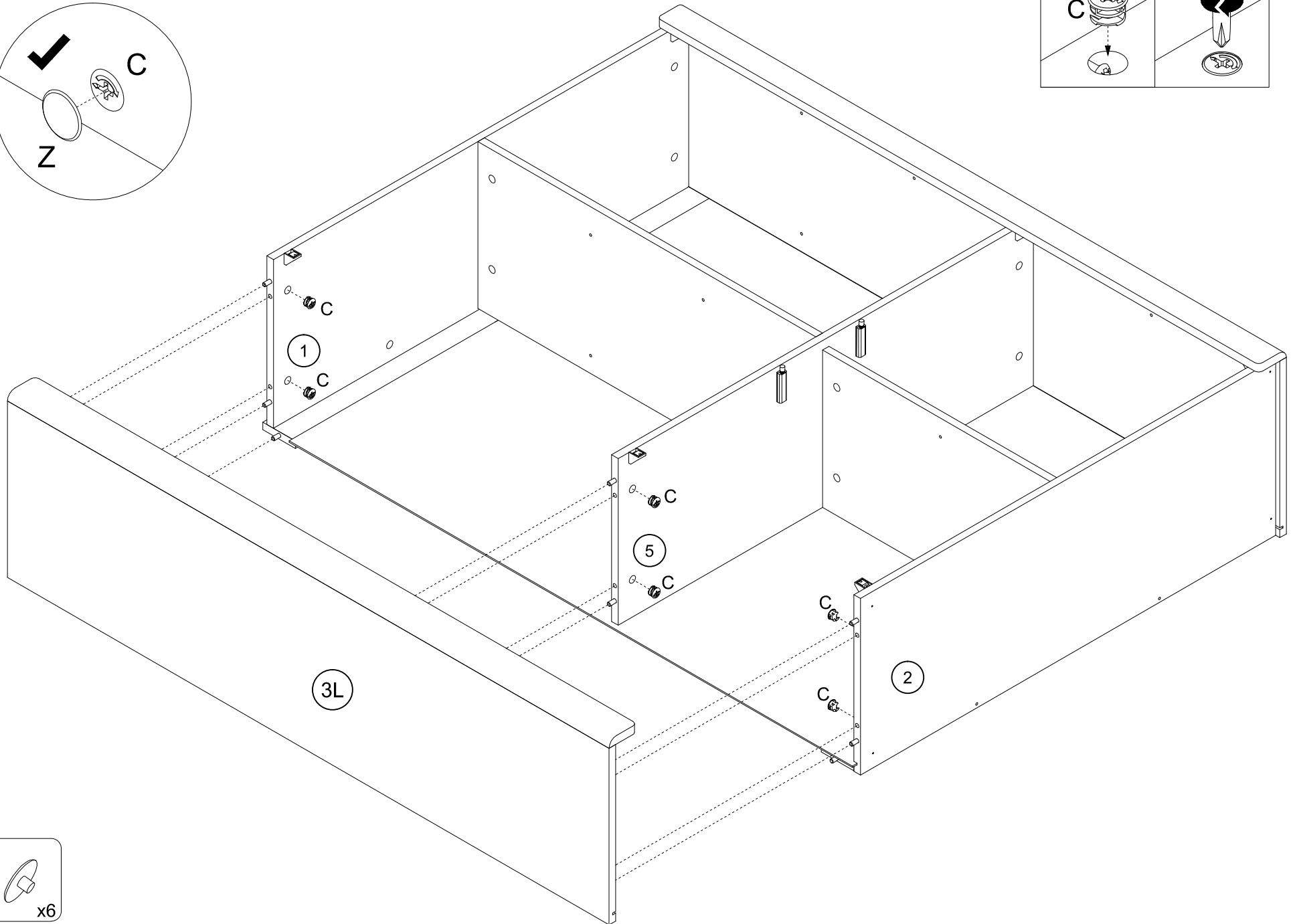
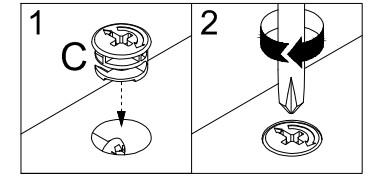
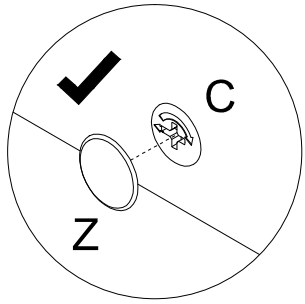

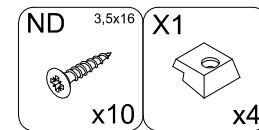
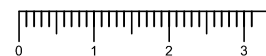
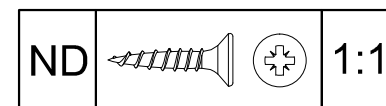
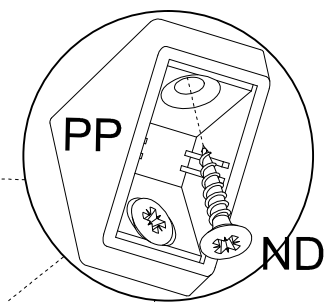
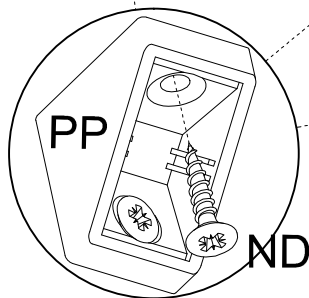
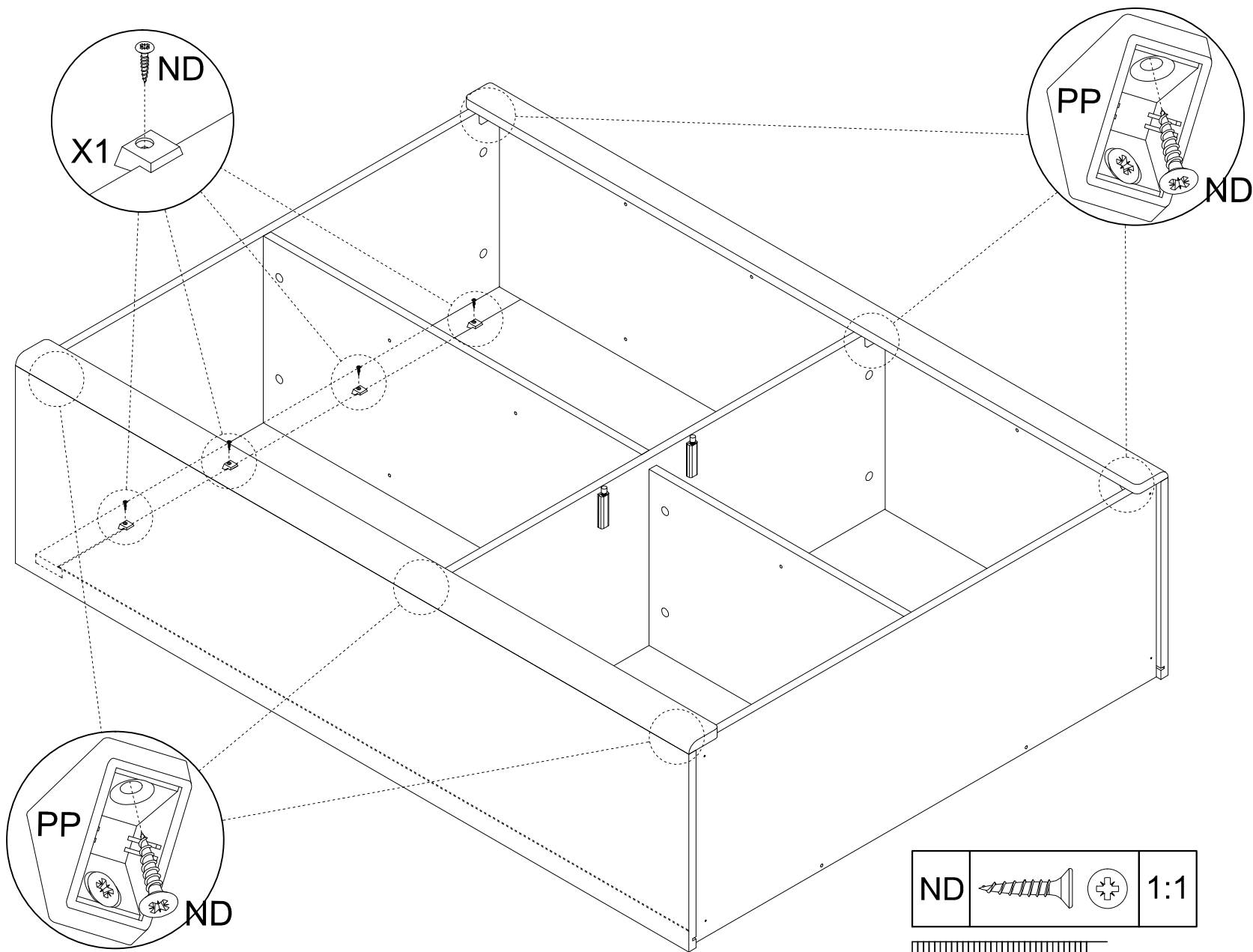

15

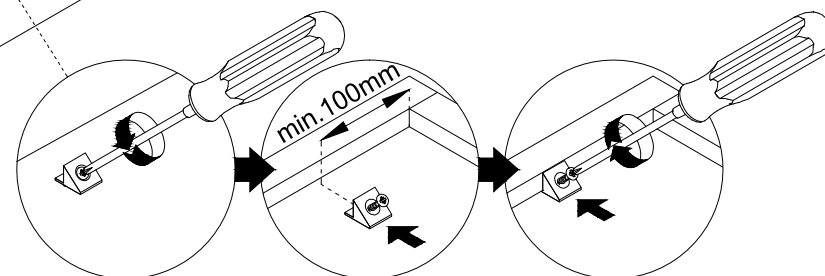
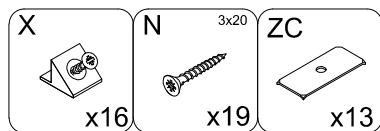
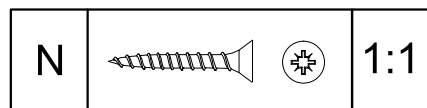
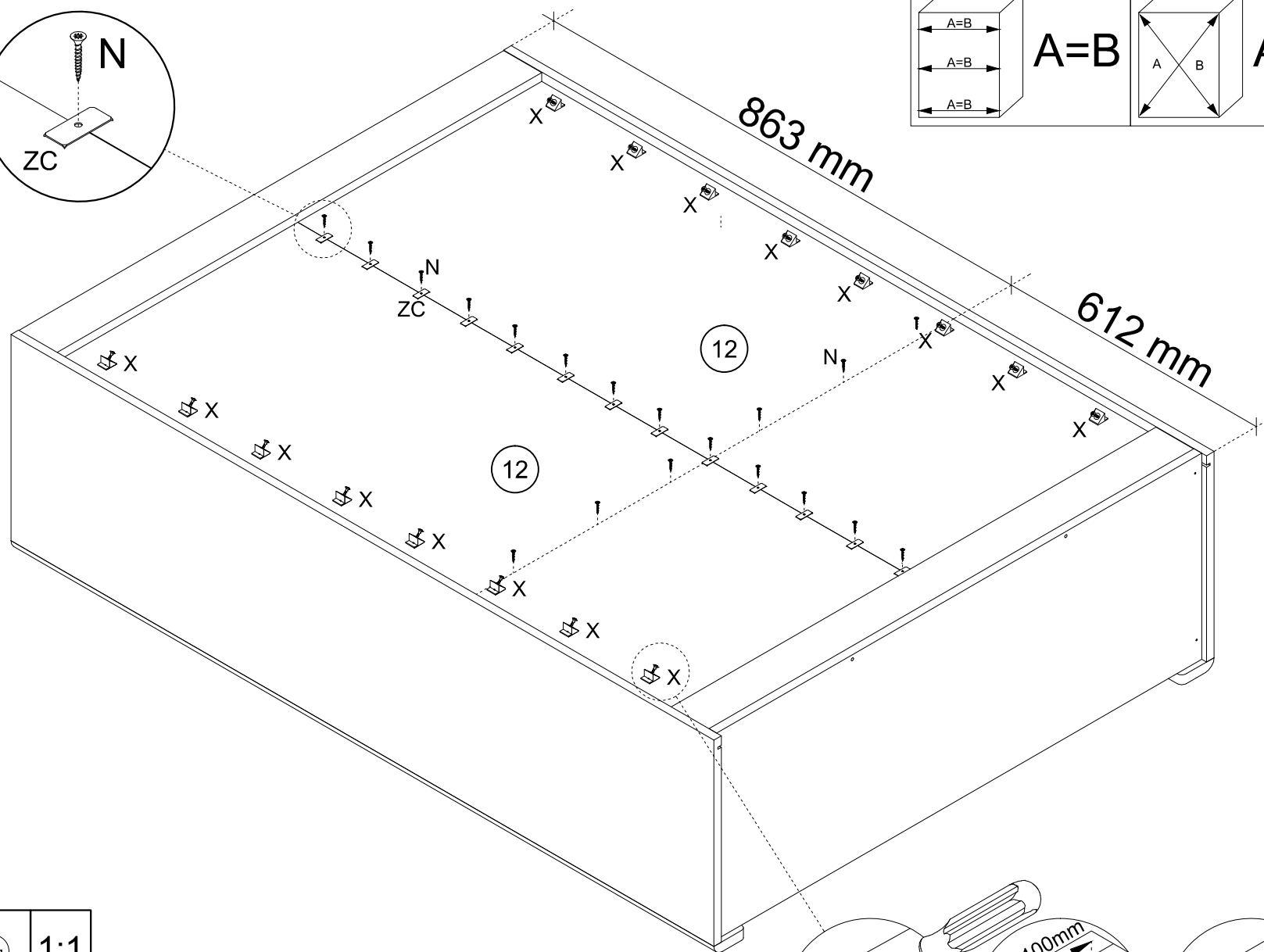
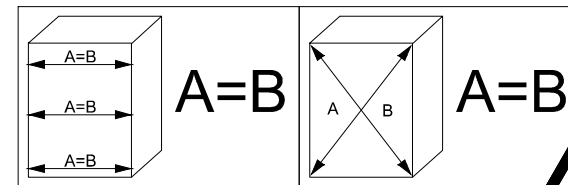
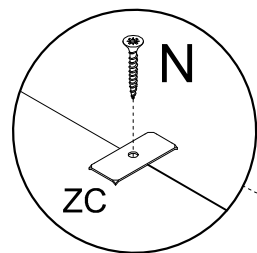

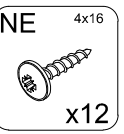
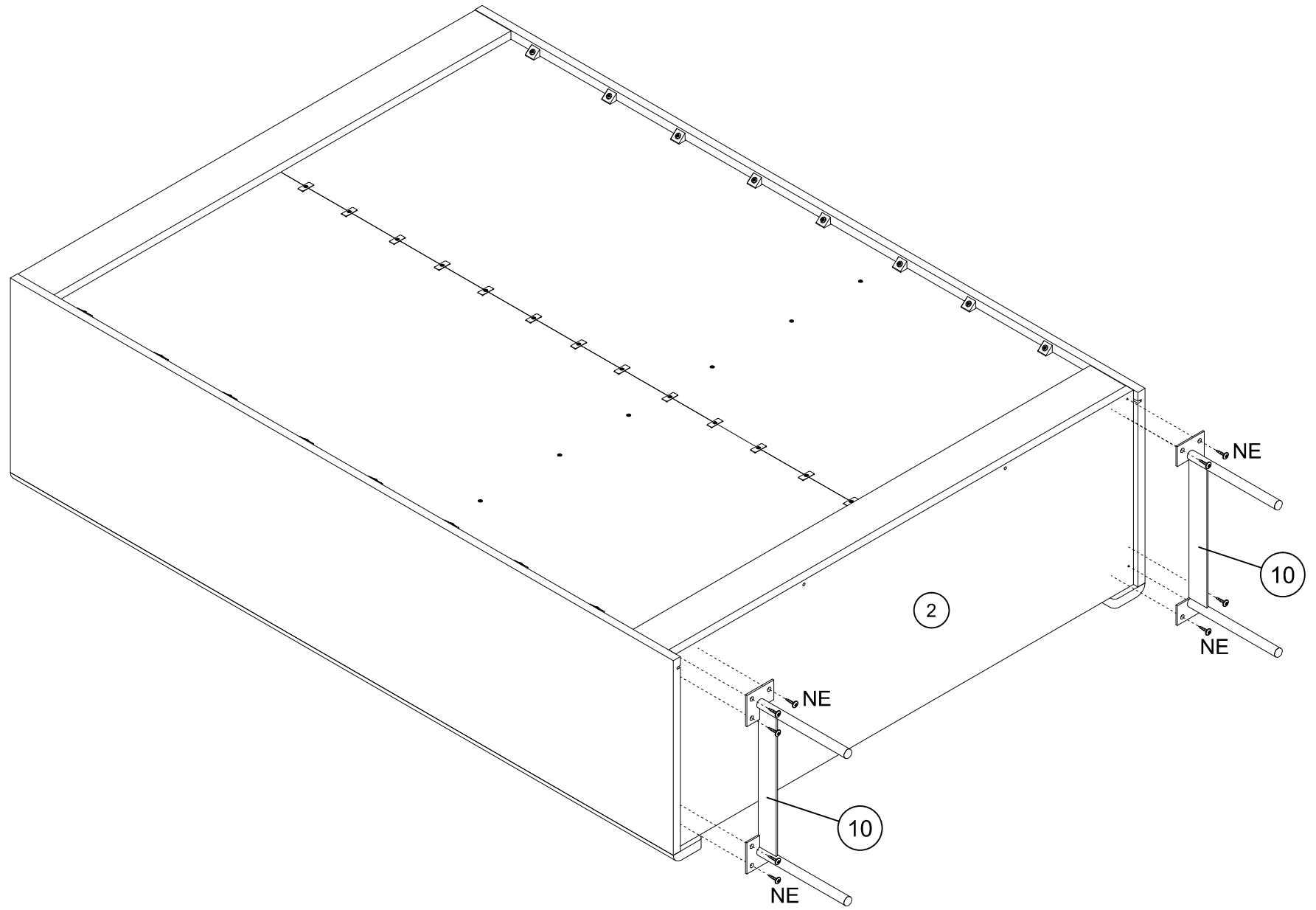

17

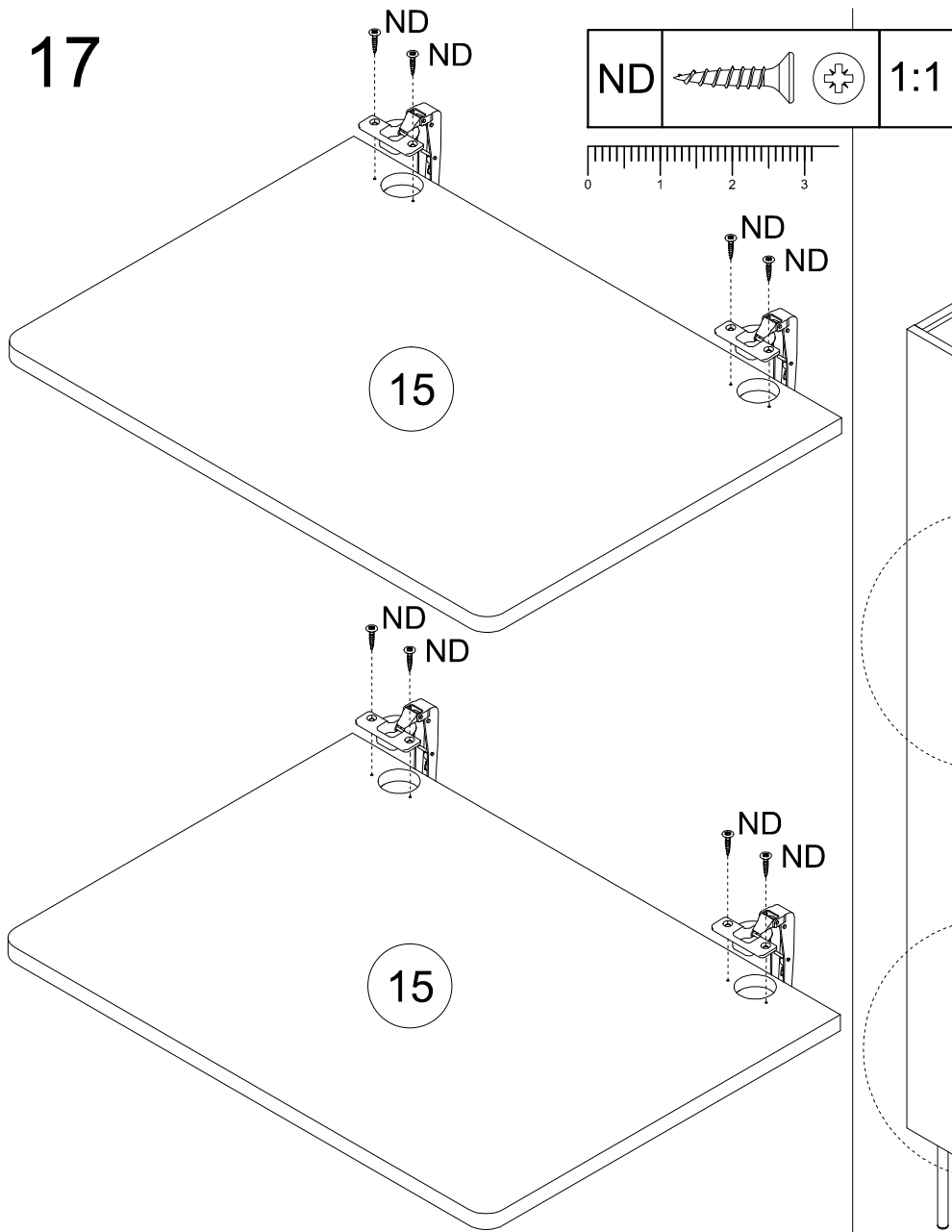

18

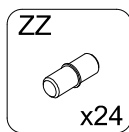
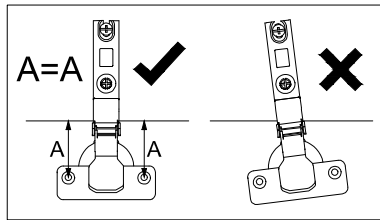
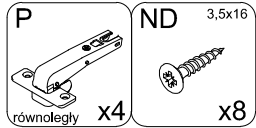
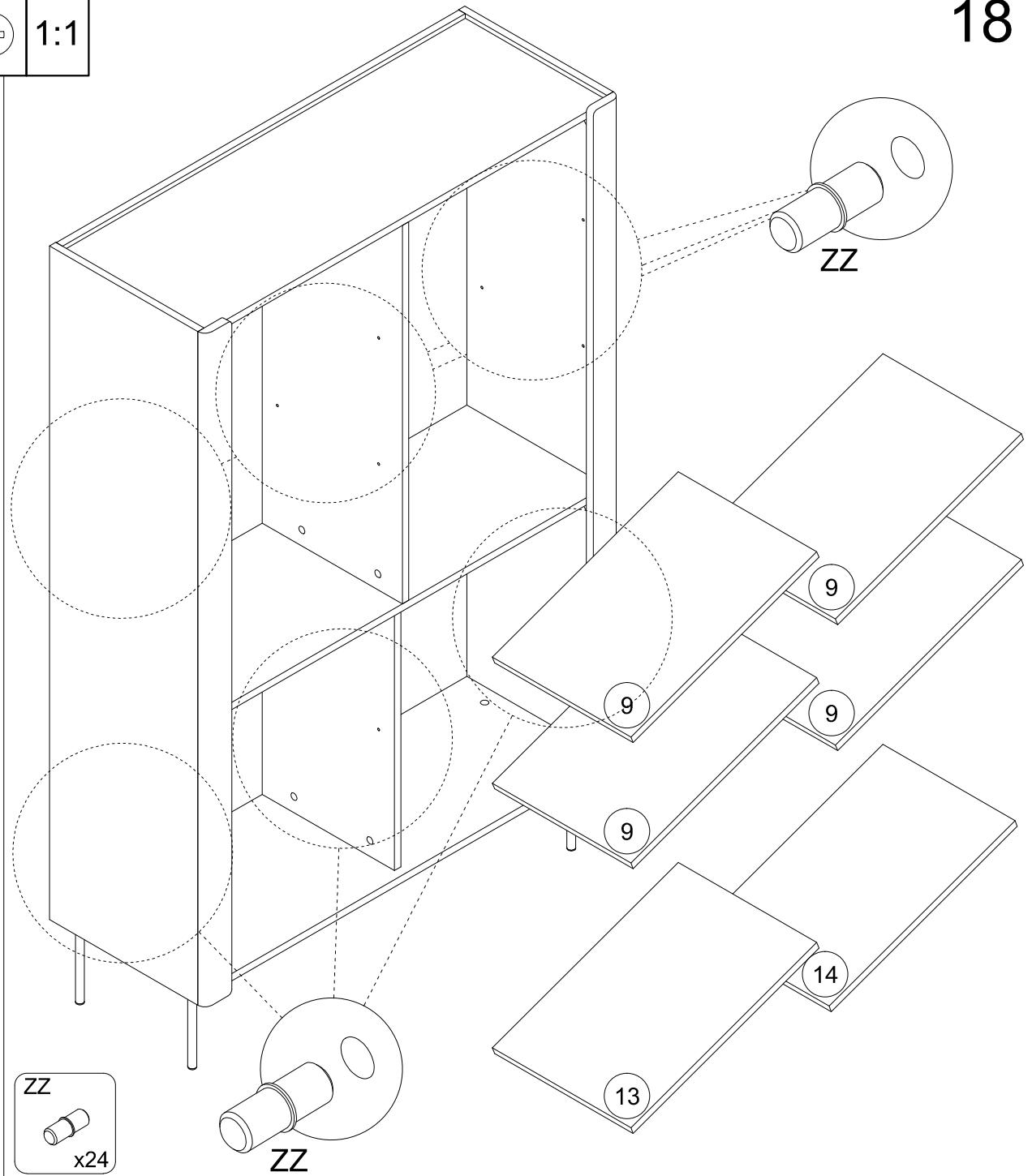

19

