

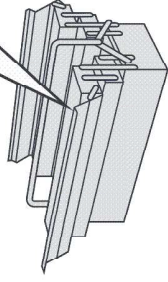

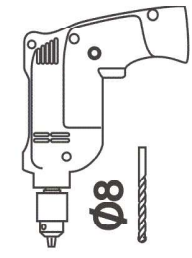

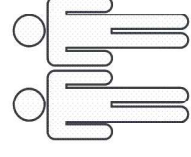

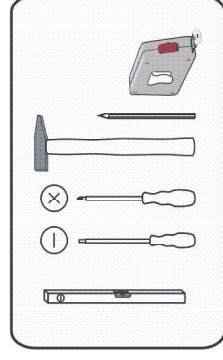
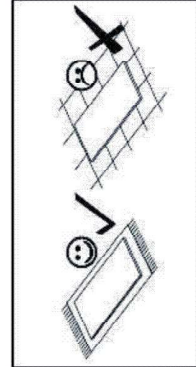
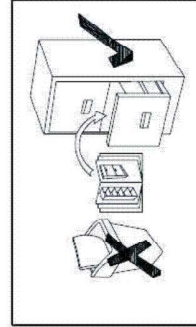
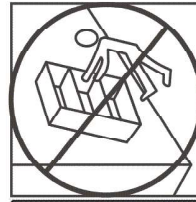
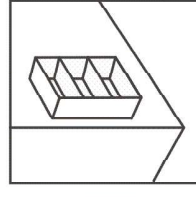
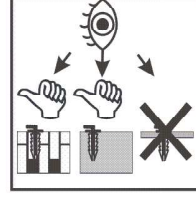
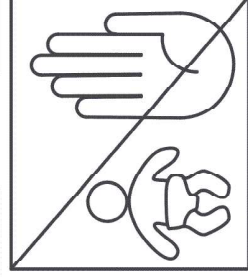
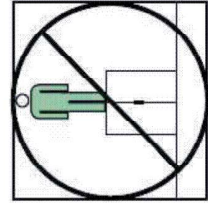
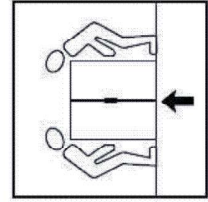
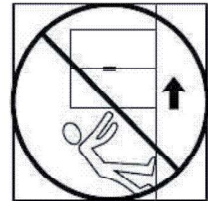
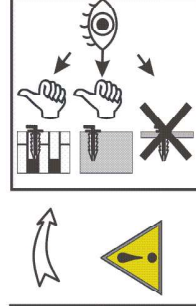
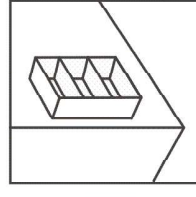
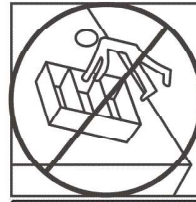
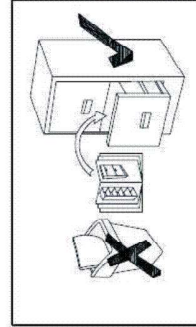
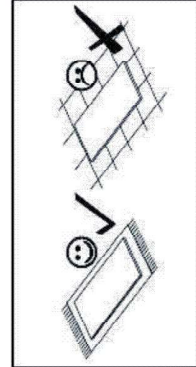
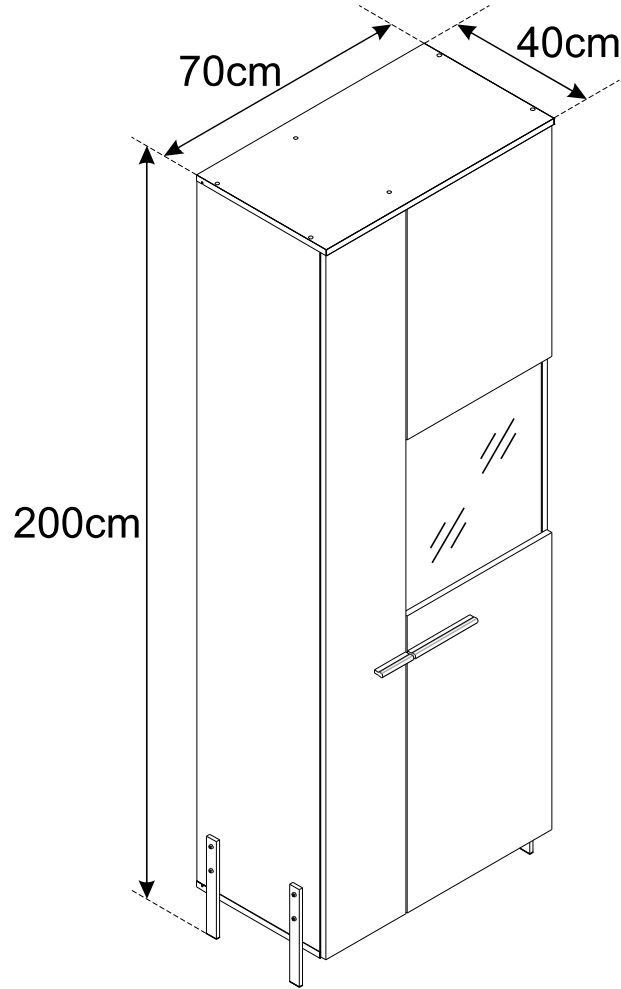
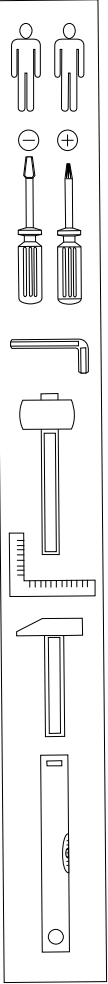
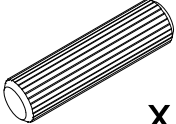
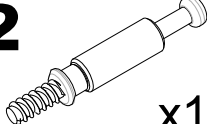
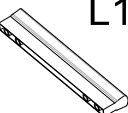

120 min

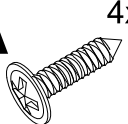
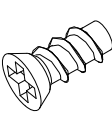

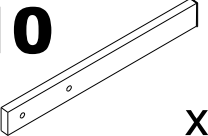
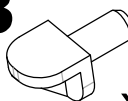
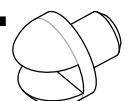
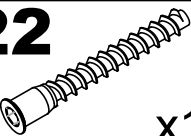

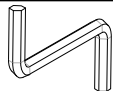
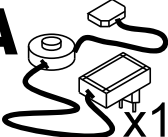
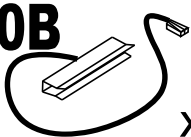
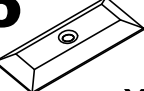
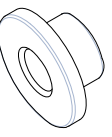
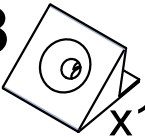
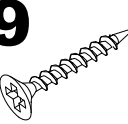
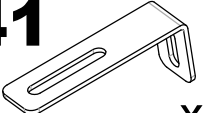
- 1**  x12
- 2**  x16
- 3A**  L192 x1
- 3B**  L96 x1
- 4**  3.5x30 x4
- 4A**  4x16 x7
- 6**  5x11 x16
- 9**  ø15 x16
- 9A**  x16
- 10**  x4
- 13**  x20
- 14**  x4
- 22**  x12
- 22A**  x12
- 26**  x1
- 30A**  x1
- 30B**  x1
- 35**  x26
- 36**  x6
- 38**  x18
- 39**  3x20 x48
- 41**  x1
- 43**  M6x30 x8
- 44**  M6 x8
- 54**  ø35 x8
- 80**  x1

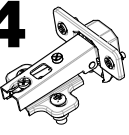
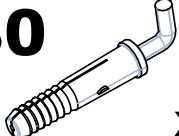
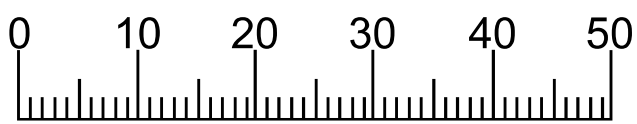

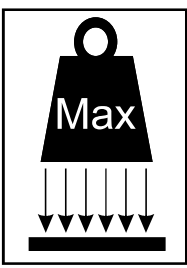
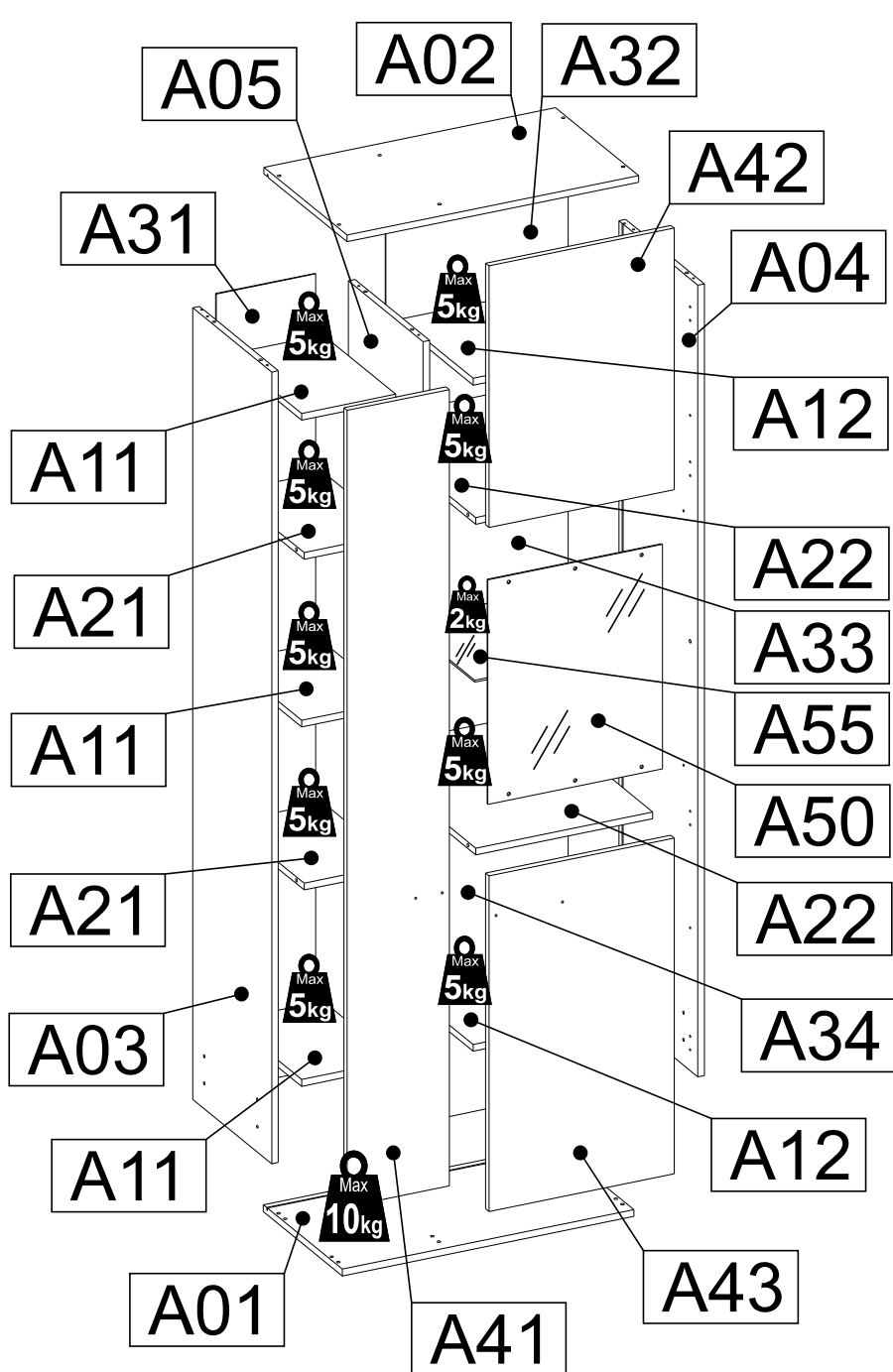

A	B (mm)	C (mm)	D (mm)	E	F
A01	702	380	16	1	1 3
A02	702	400	16	1	1 3
A03	1868	380	16	1	2 3
A04	1868	380	16	1	2 3
A05	1868	360	16	1	2 3
A11	226	350	16	3	1 3
A12	426	350	16	2	1 3
A21	226	360	16	2	1 3
A22	426	360	16	2	1 3
A31	1878	239	3	1	2 3
A32	565	439	3	1	3 3
A33	600	439	3	1	3 3
A34	713	439	3	1	3 3
A41	1879	246	16	1	2 3
A42	617	446	16	1	3 3
A43	792	446	16	1	3 3
A50	530	420	4	1	3 3
A55	419	350	5	1	1 3

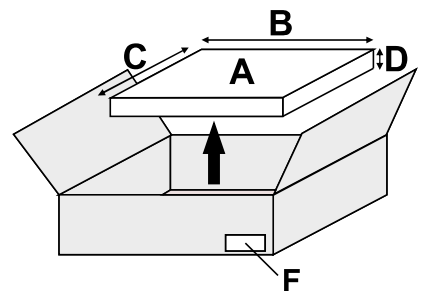

1

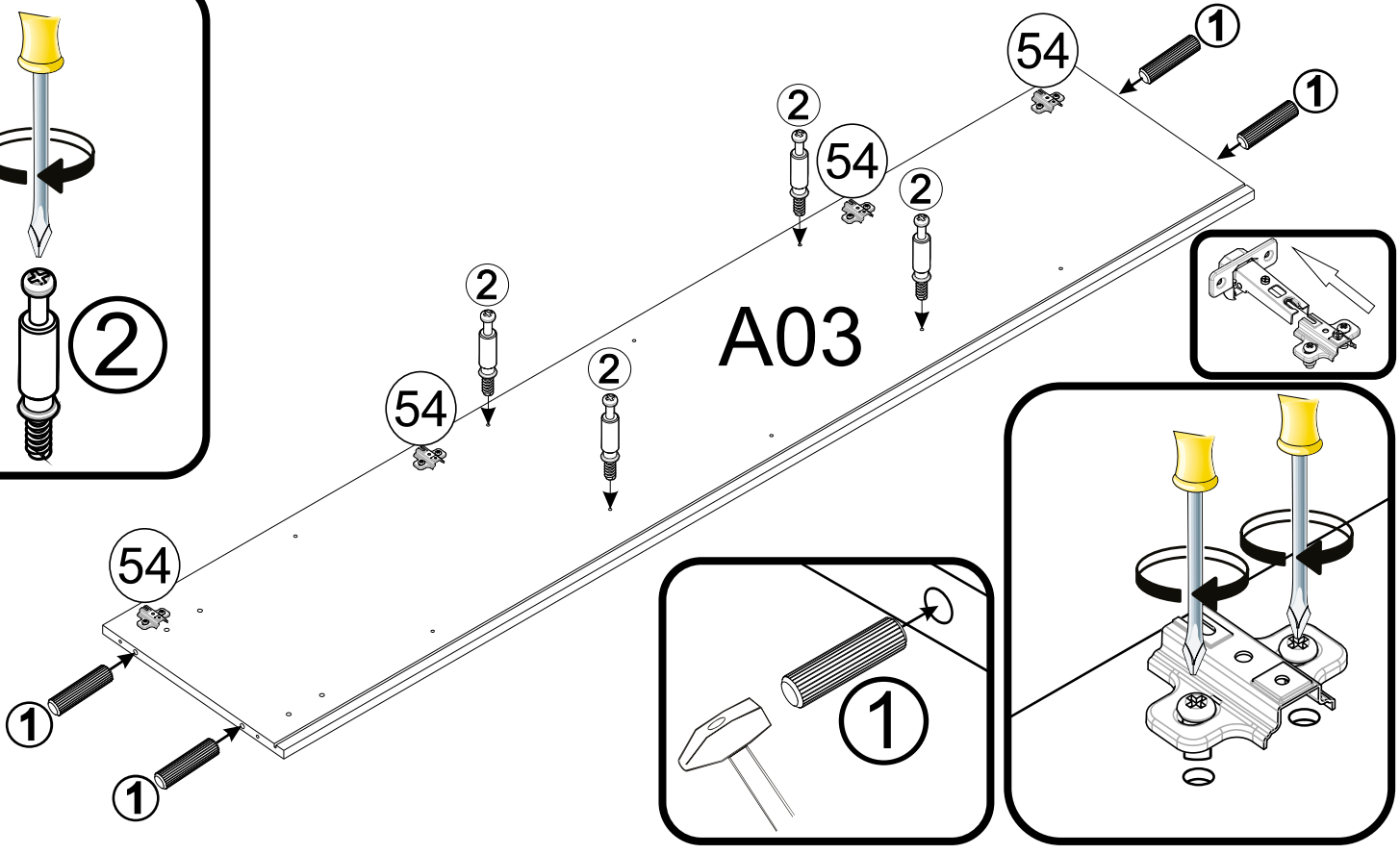
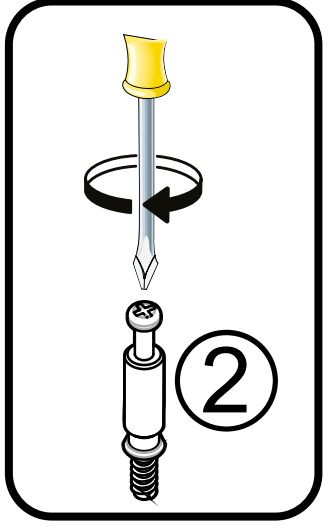
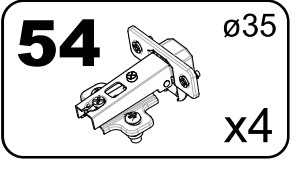
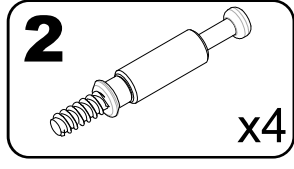
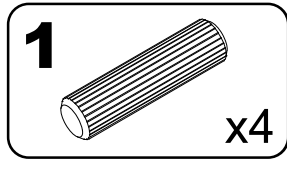

2

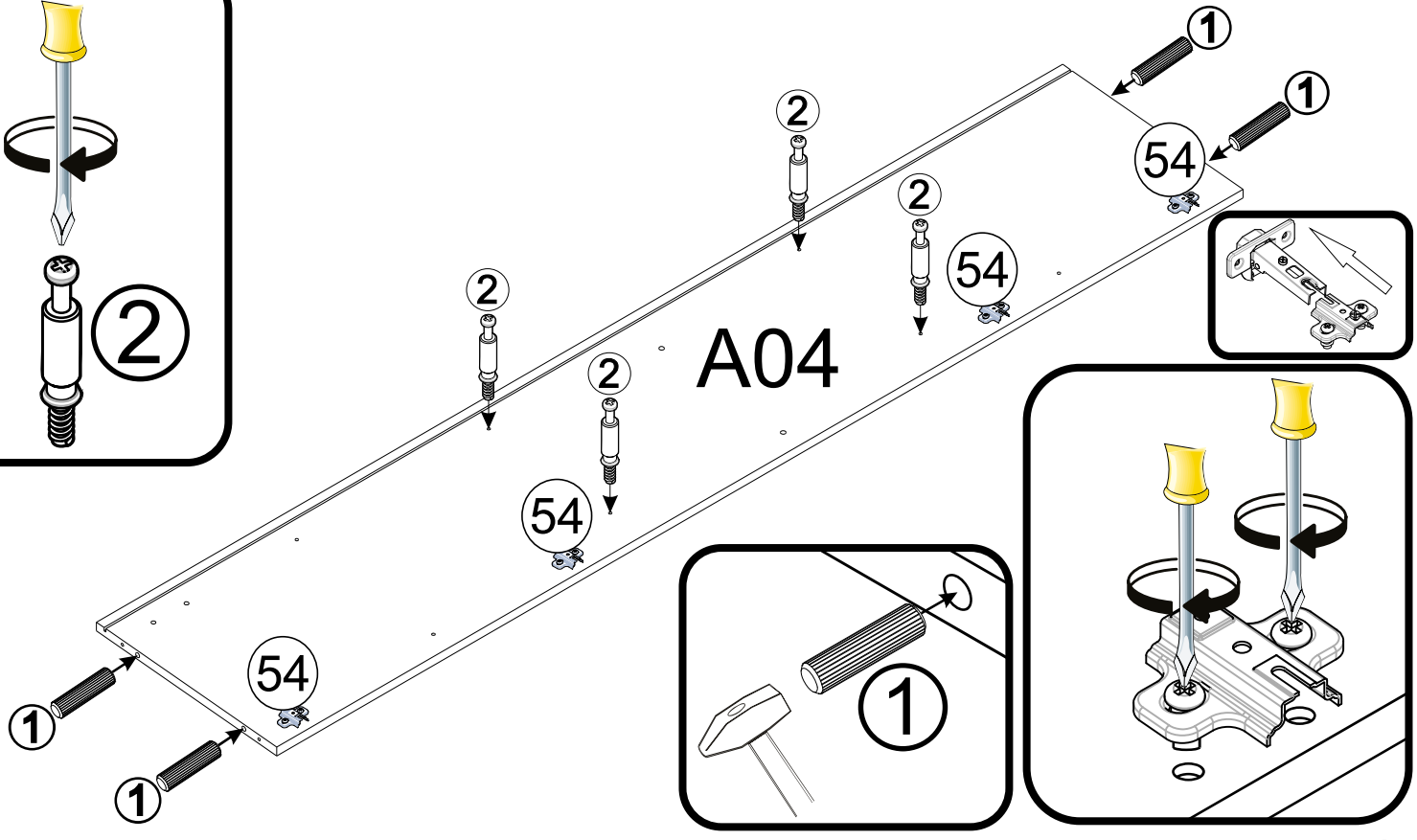
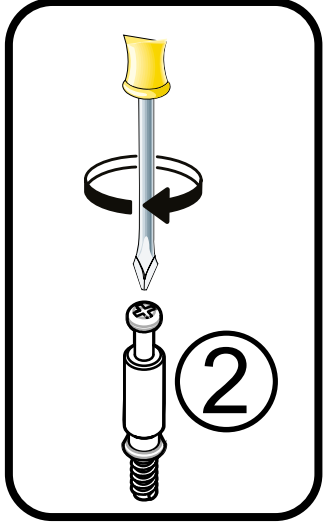
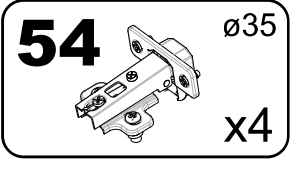
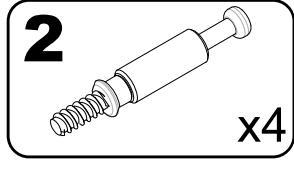
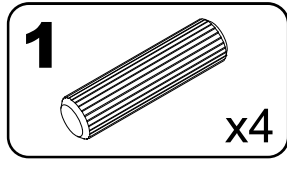

3

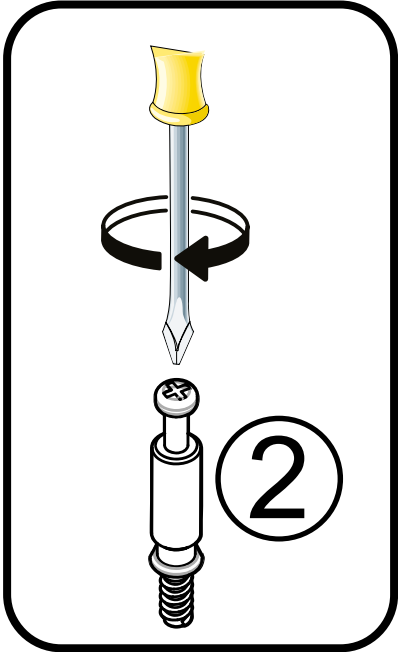
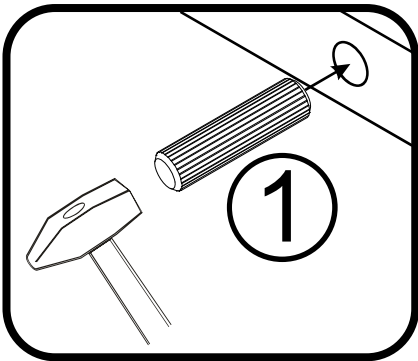
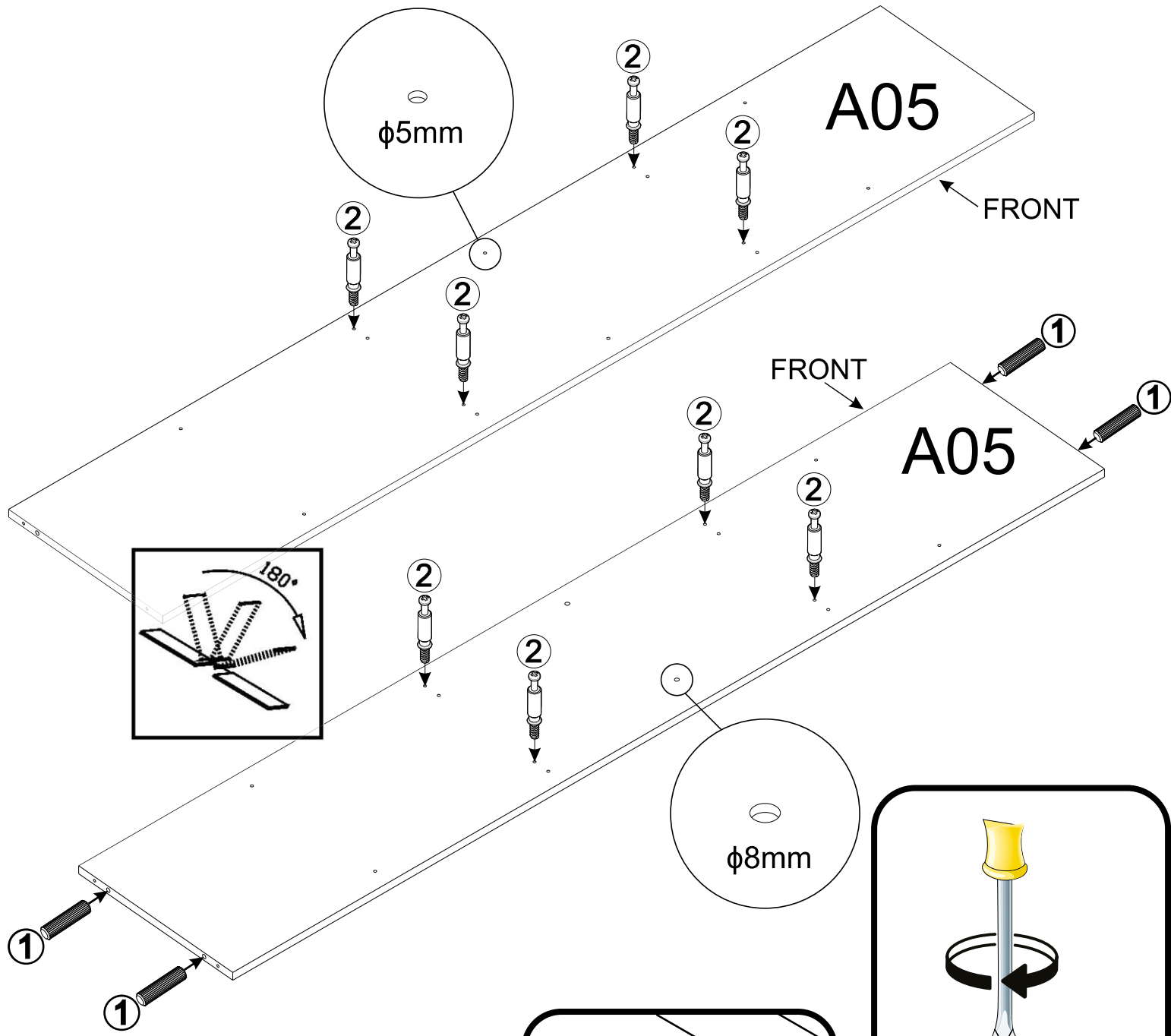
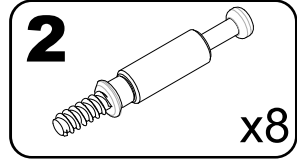
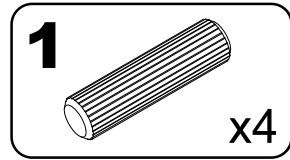

4

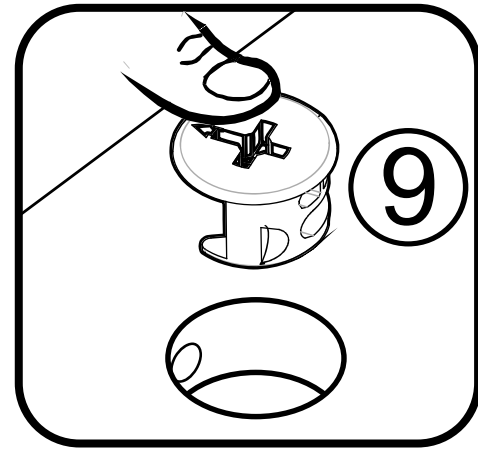
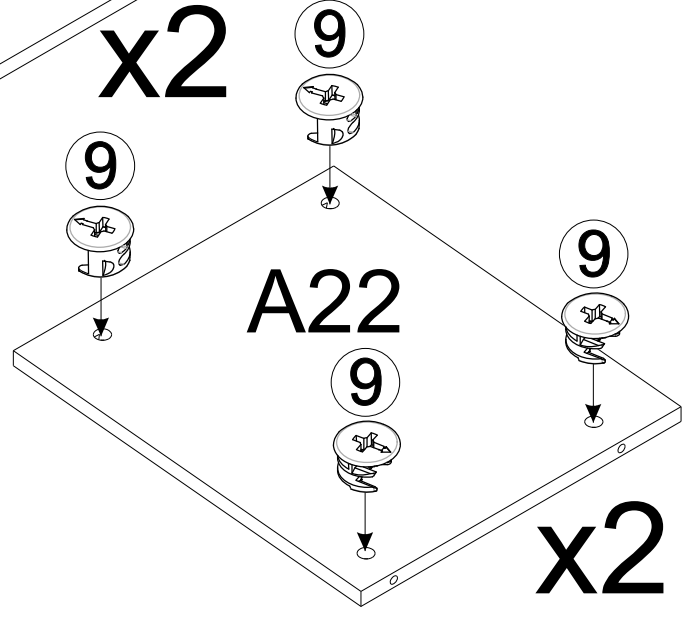
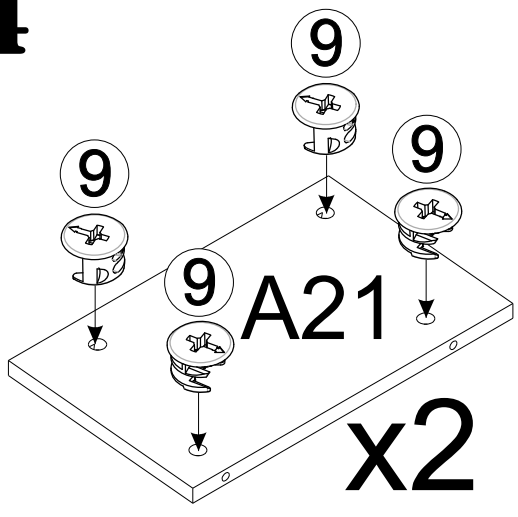
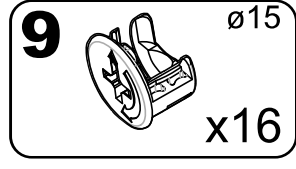

5

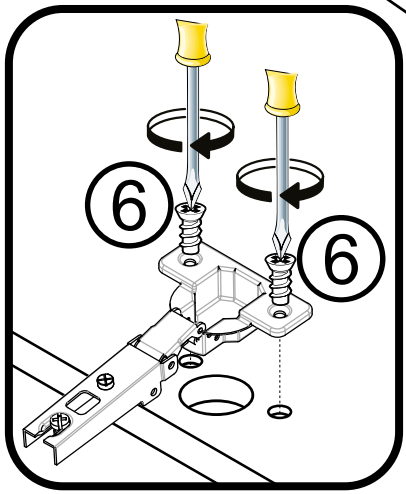
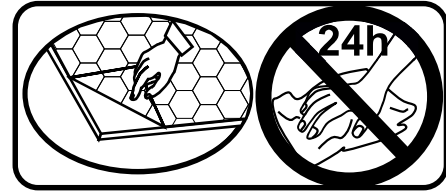
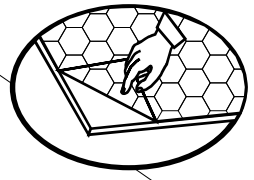
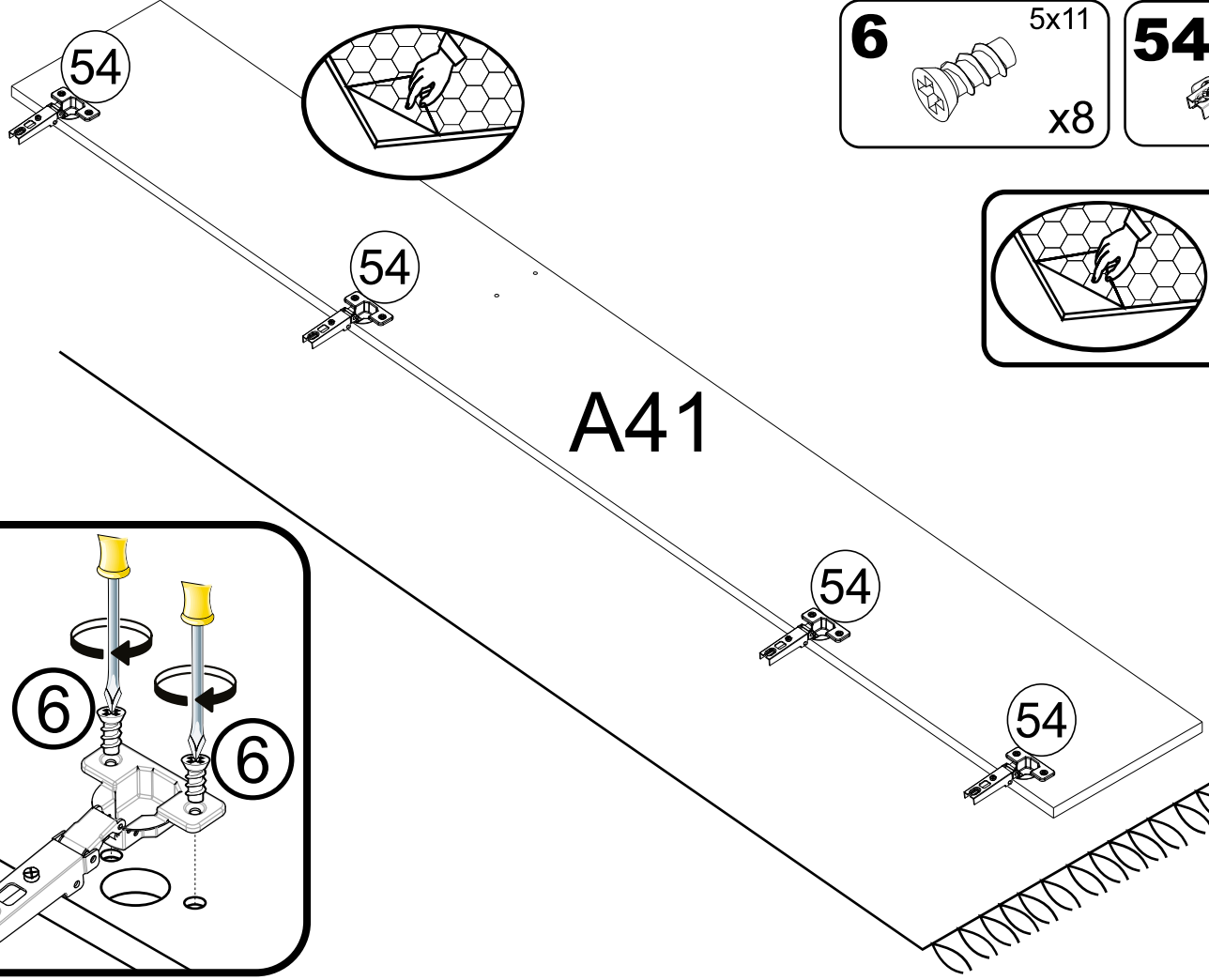
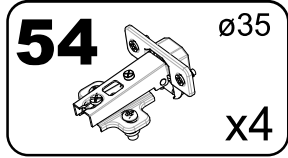
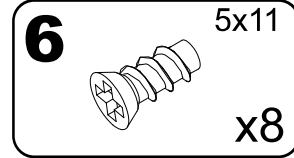

6

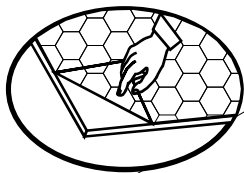
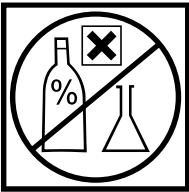
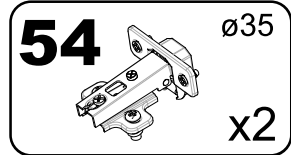
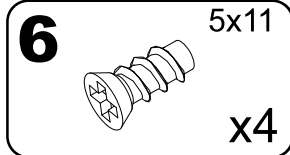
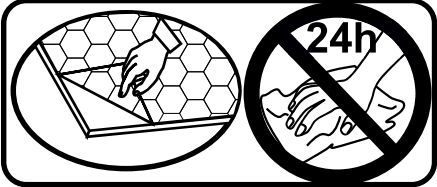

54

A42

54

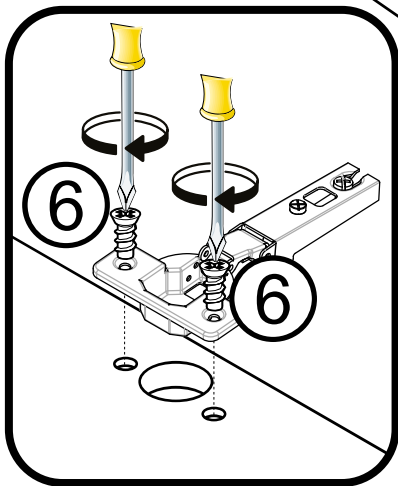

7

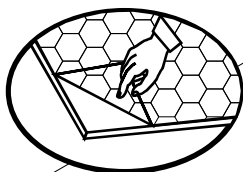
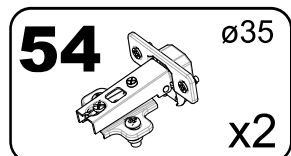
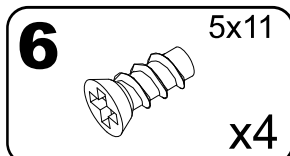
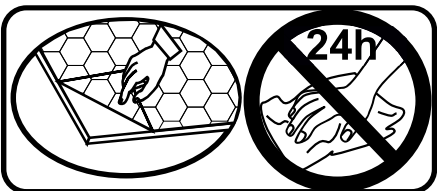

54

A43

54

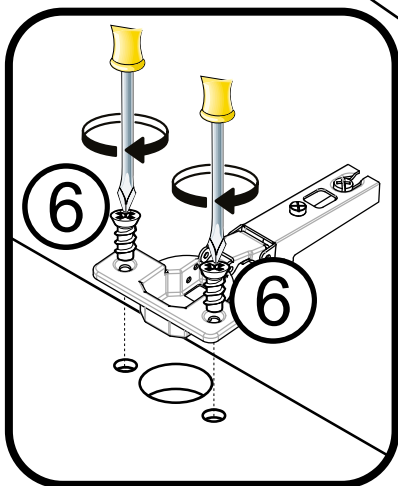

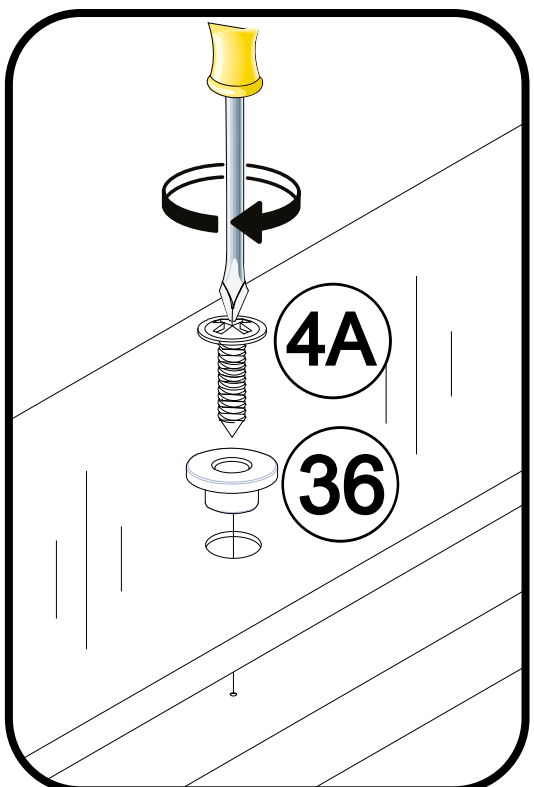
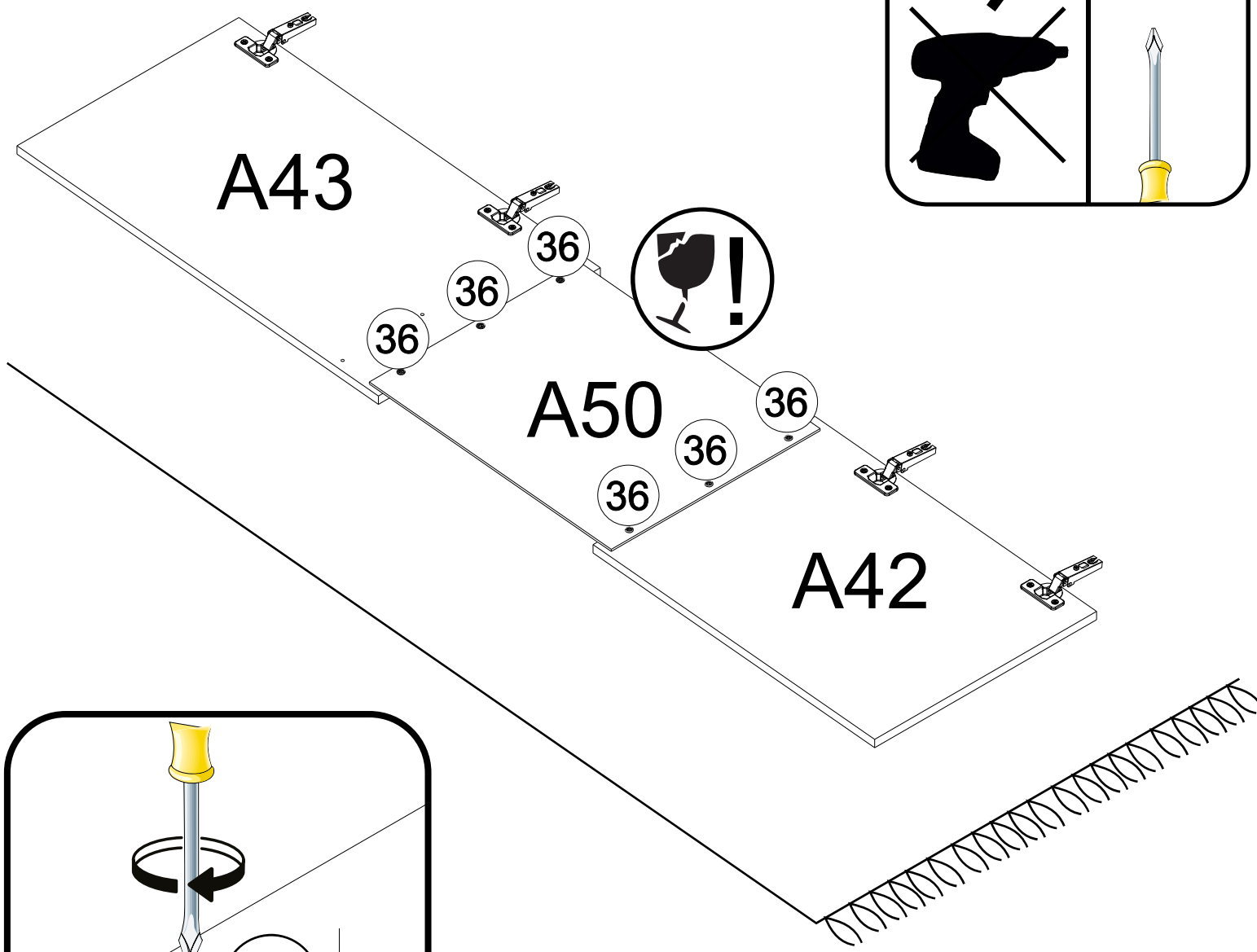
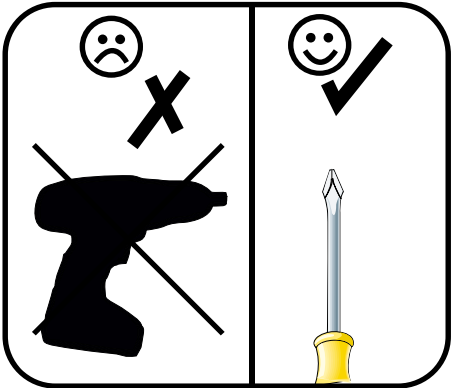
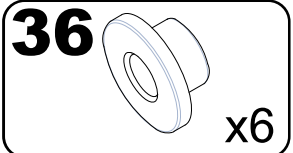
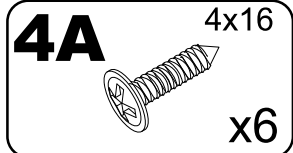

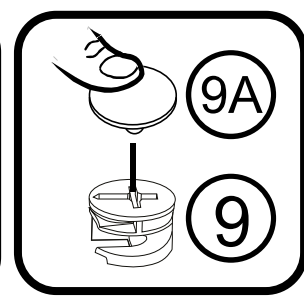
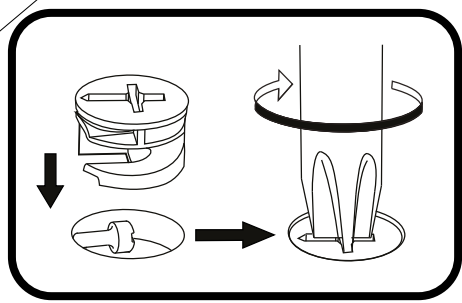
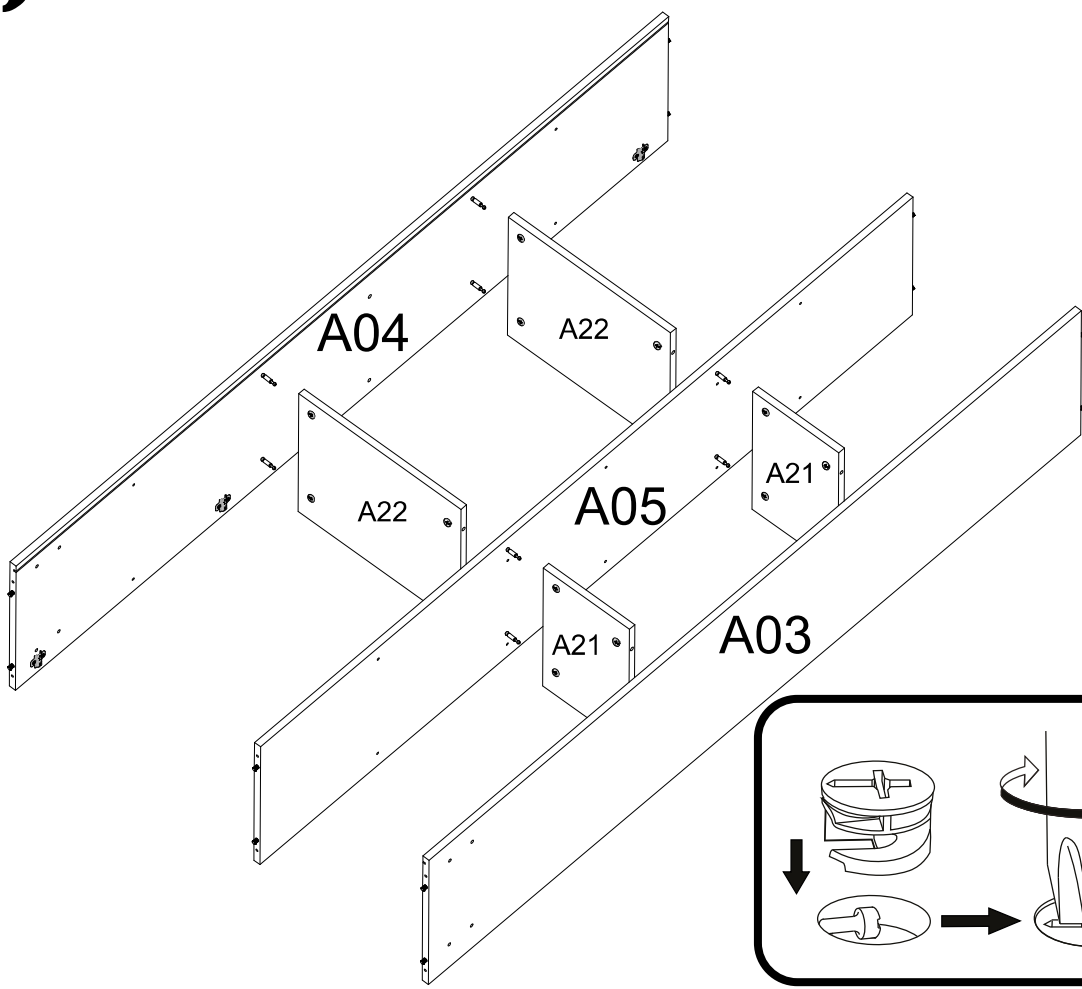

9

9A  x16



10

22  x6

22A  x6

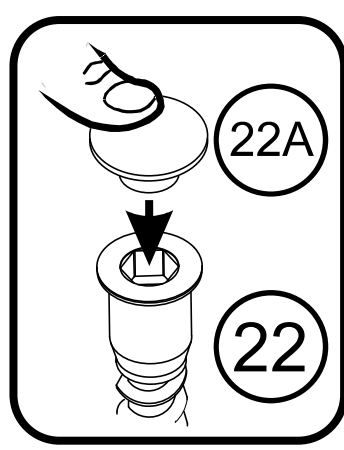
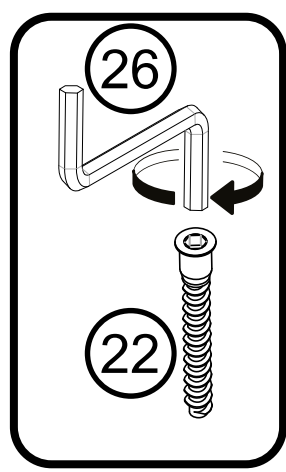
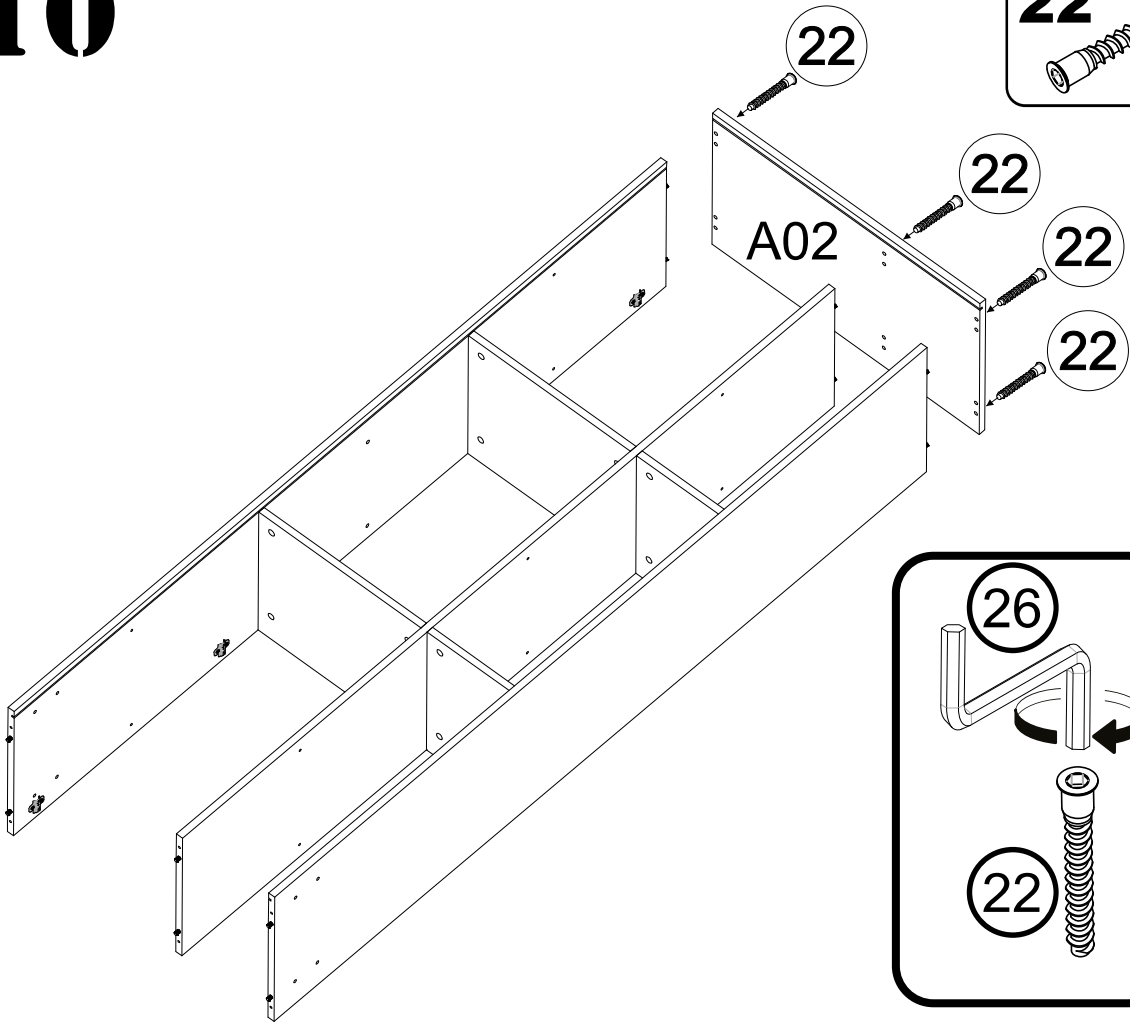

11

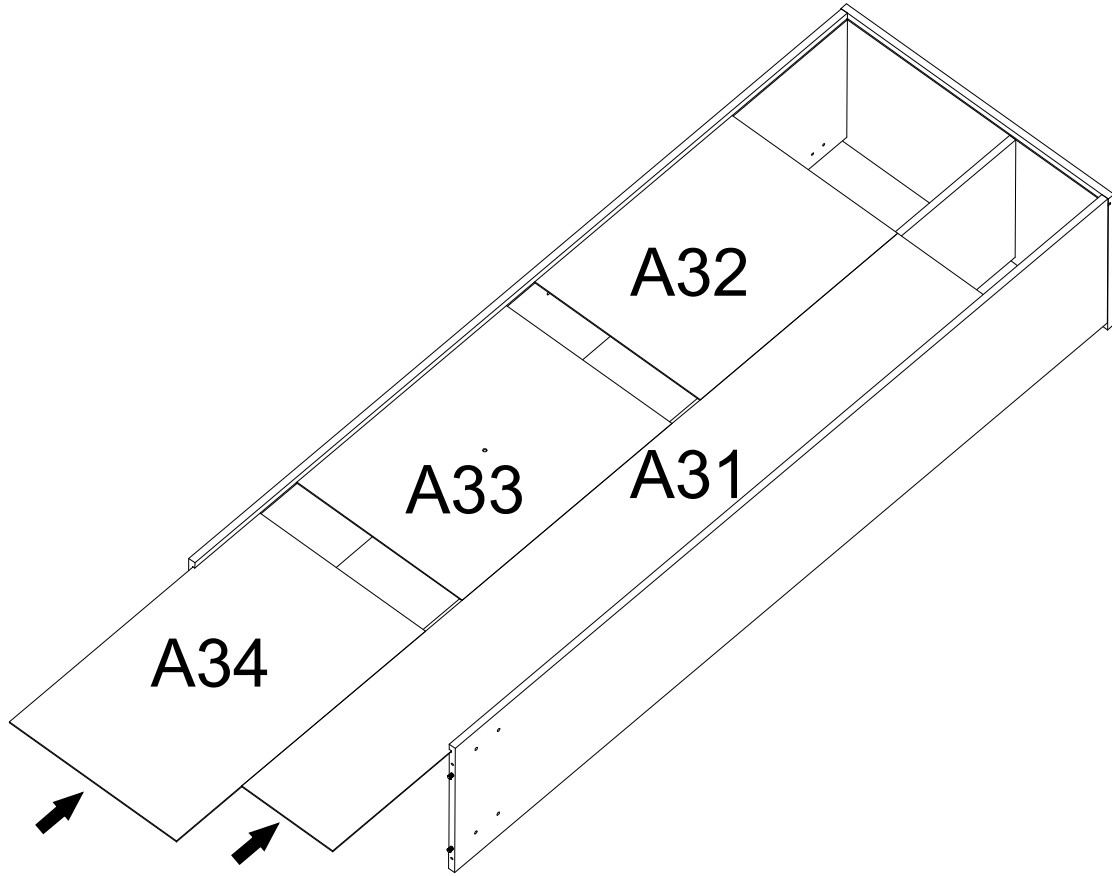

12

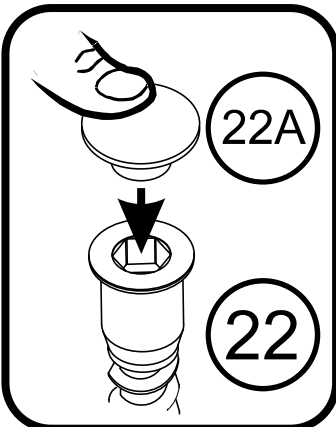
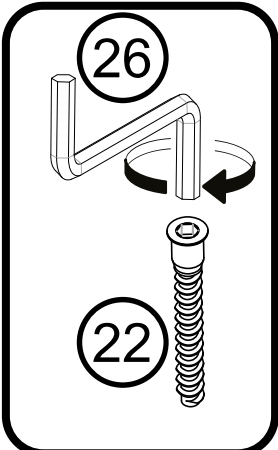
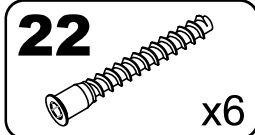
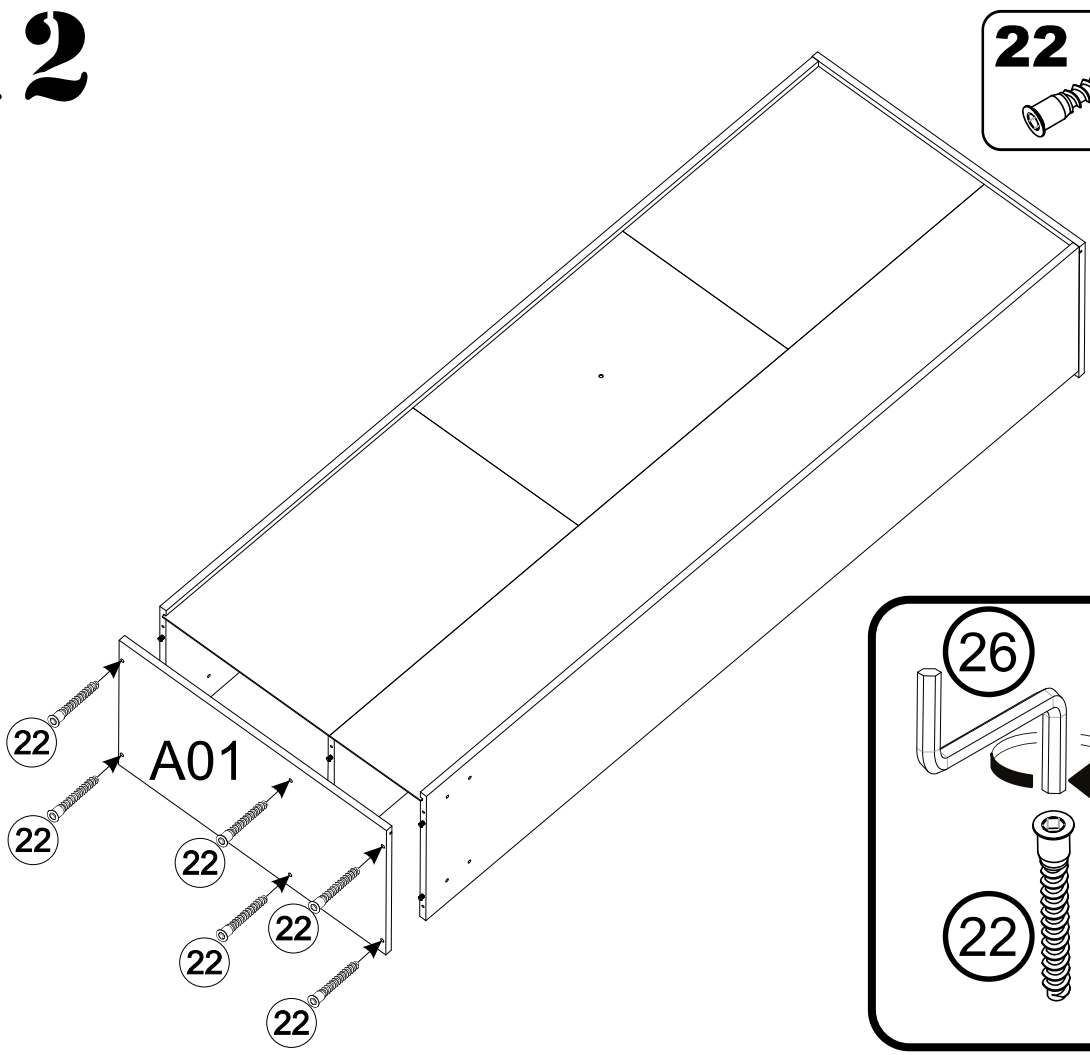

13

A=B

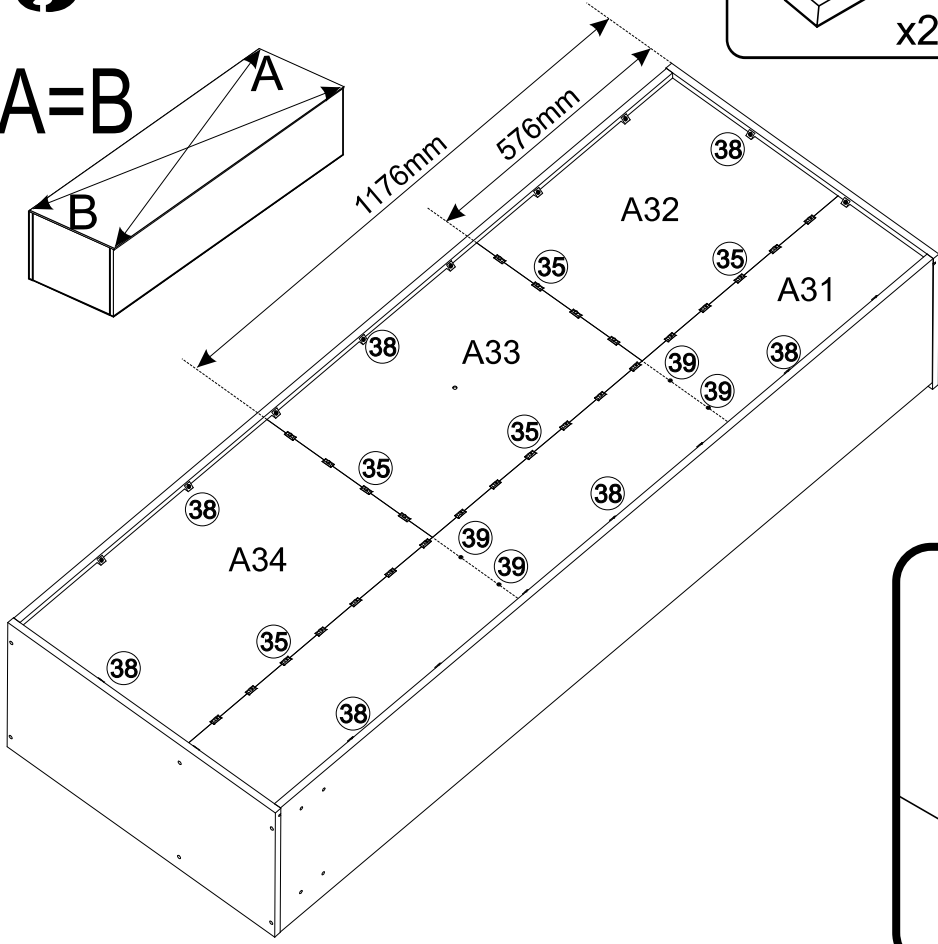

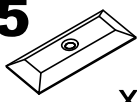
35  x26

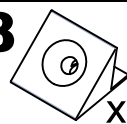
38  x18

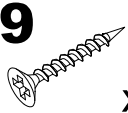
39  3x20 x48

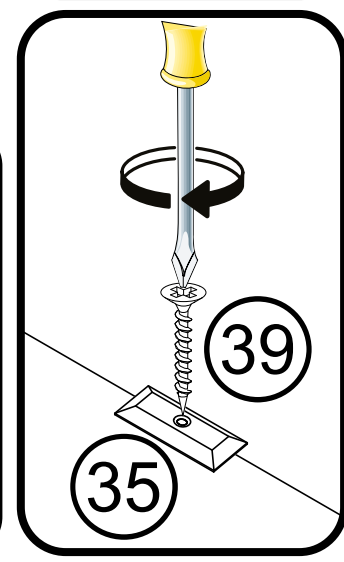
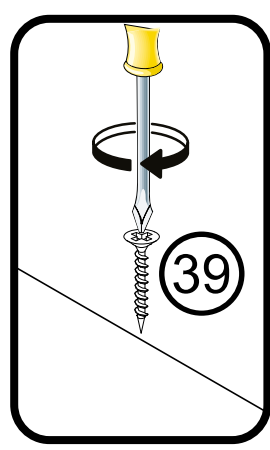
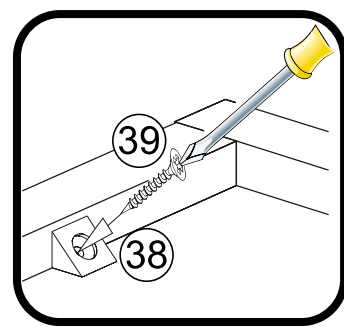

14

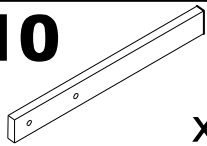
10  x4

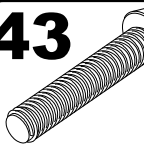
43  M6x30 x8

44  M6 x8

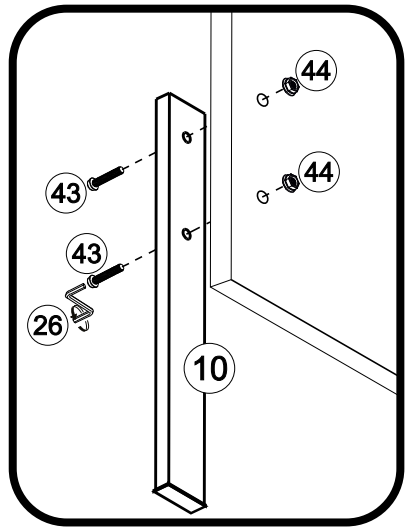
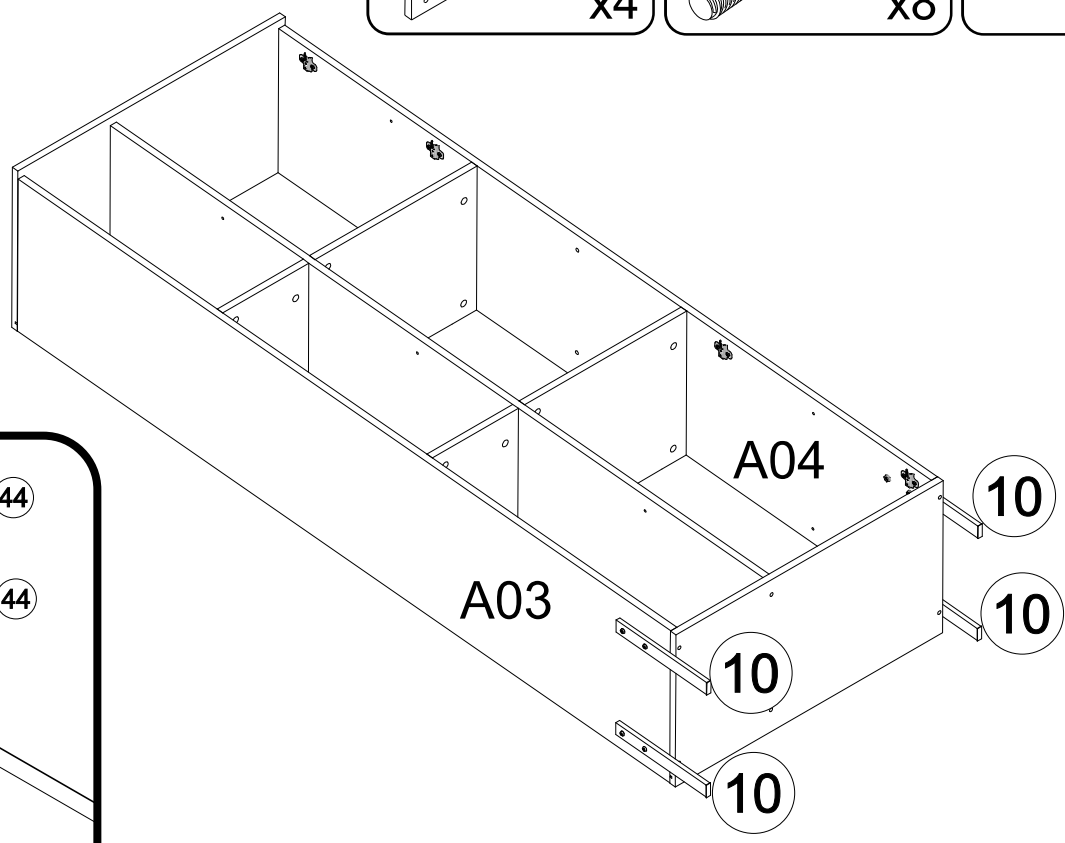

15

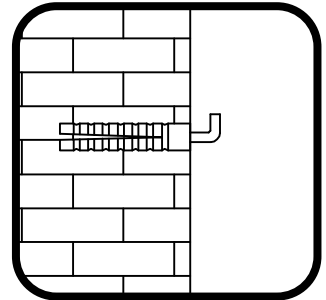
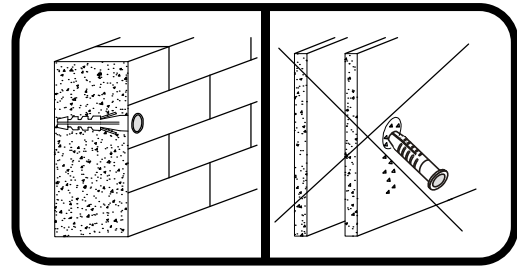
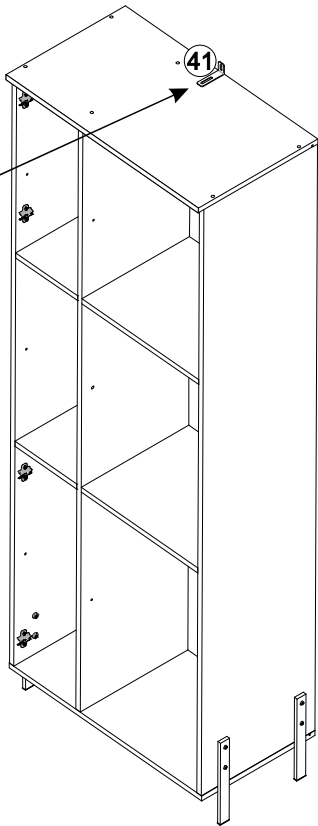
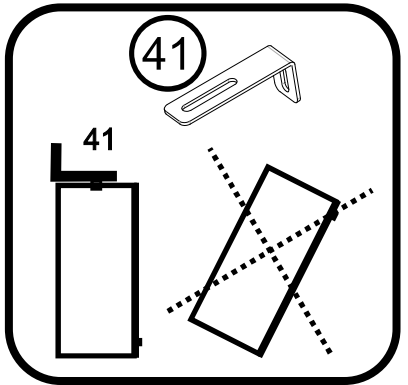
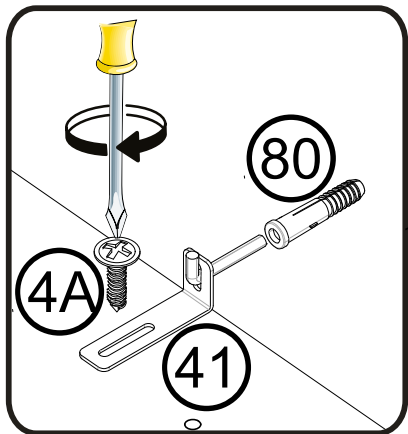
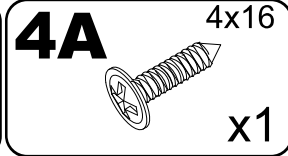
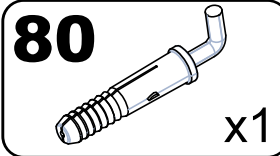
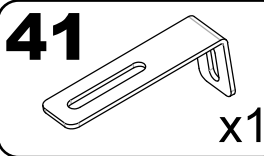

16

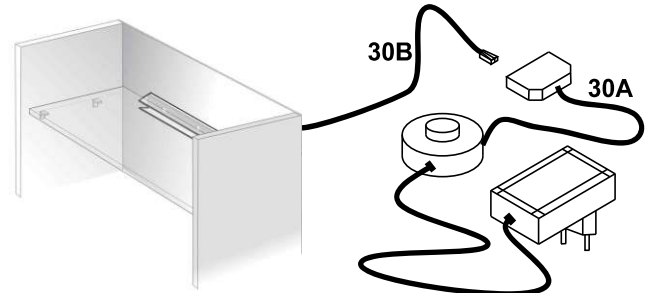
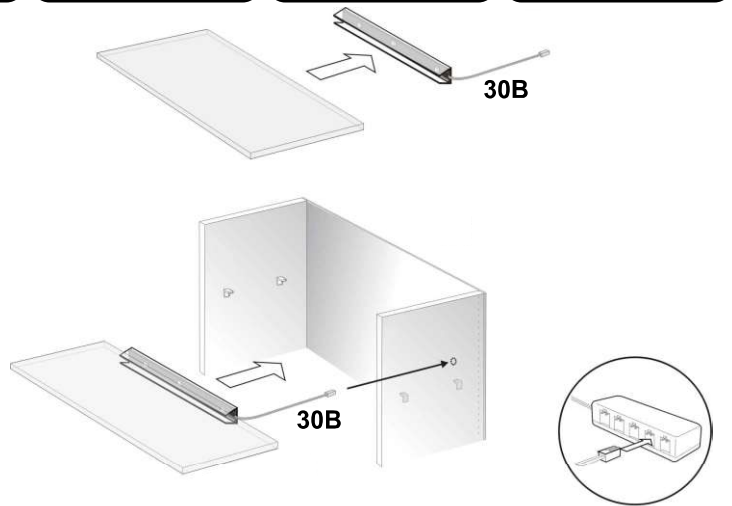
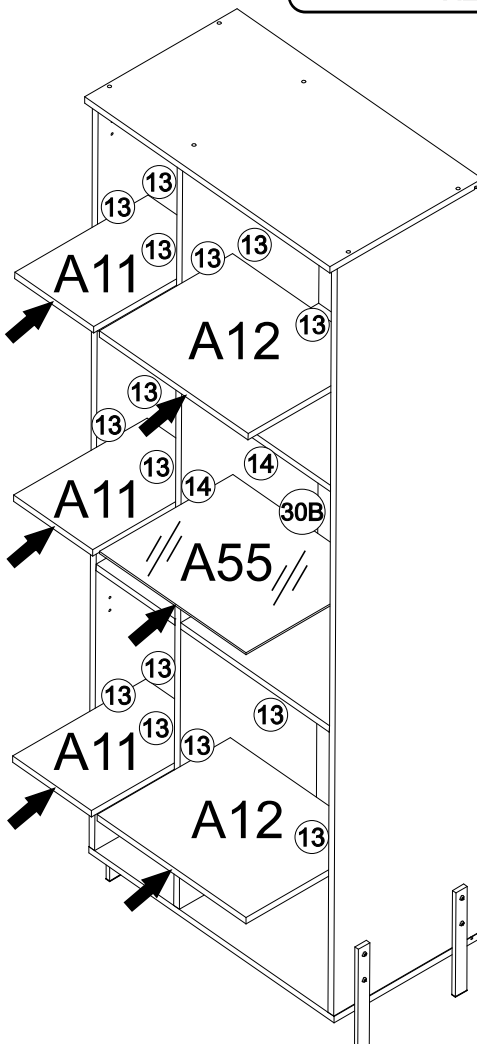
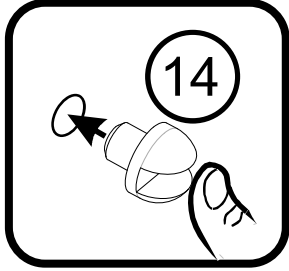
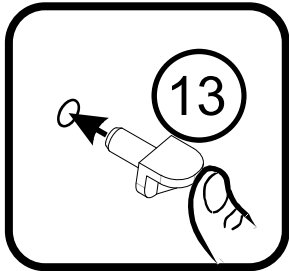
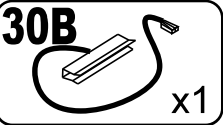
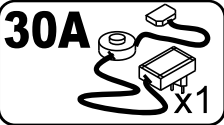
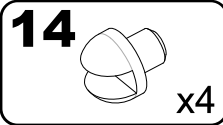
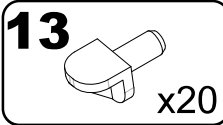

17

