

120 min

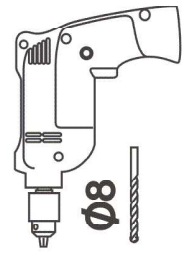

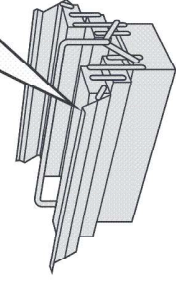

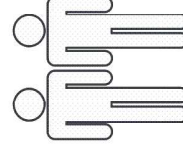
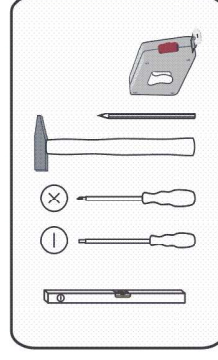
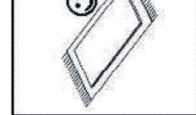
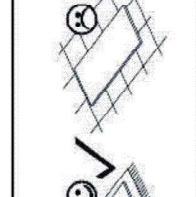
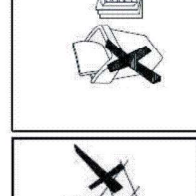
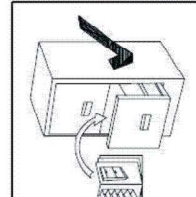
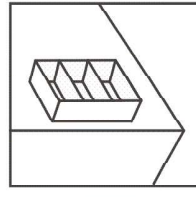
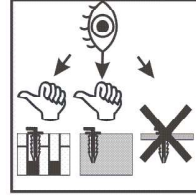
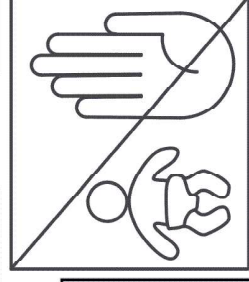
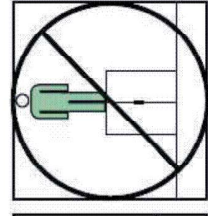
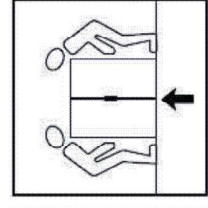
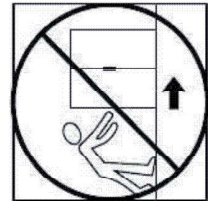
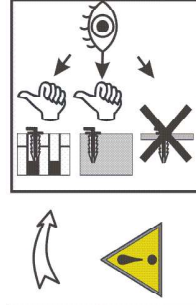
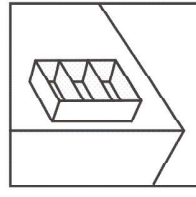
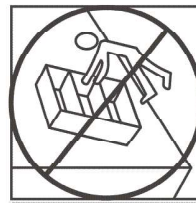
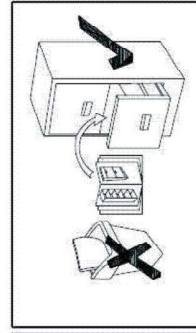
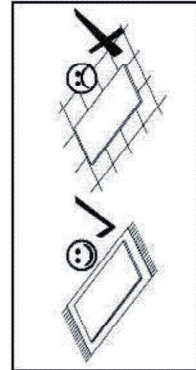
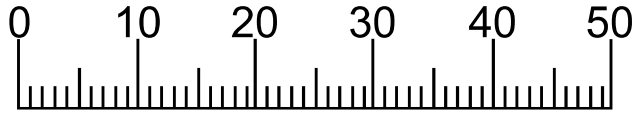
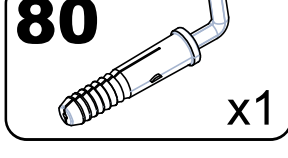
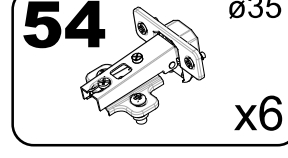
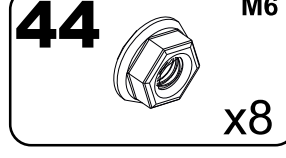
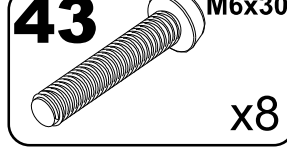
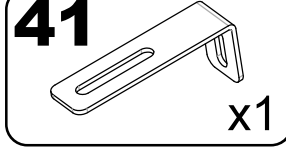
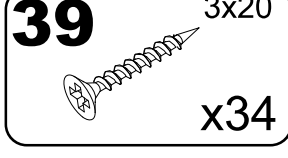
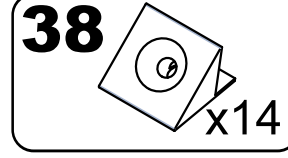
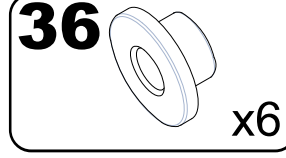
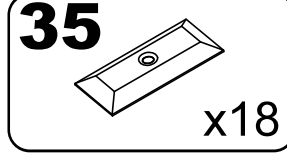
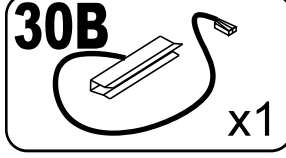
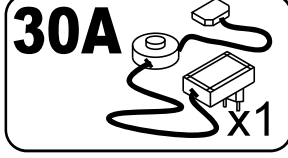
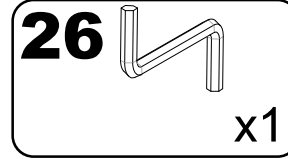
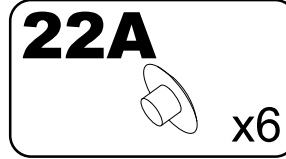
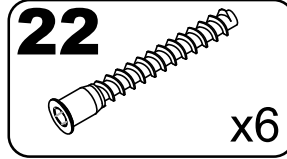
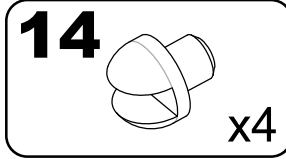
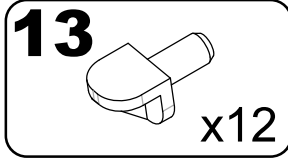
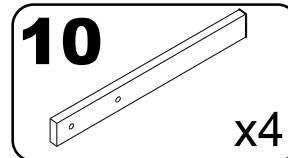
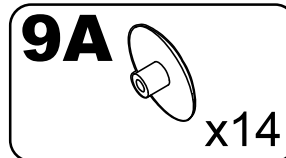
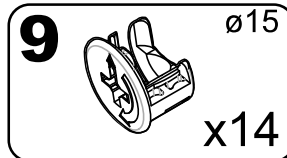
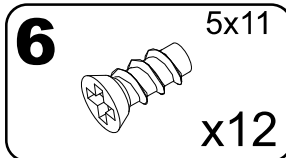
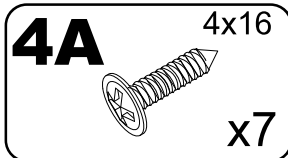
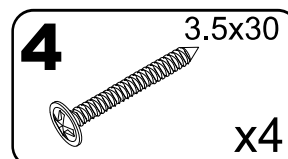
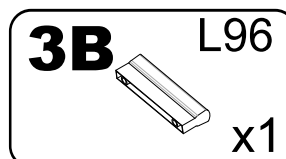
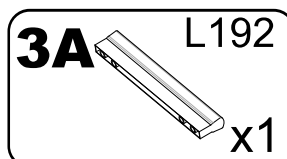
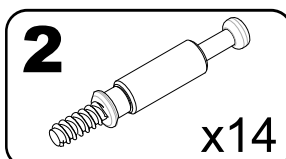
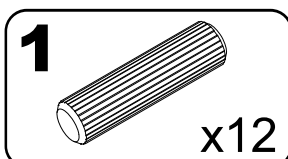
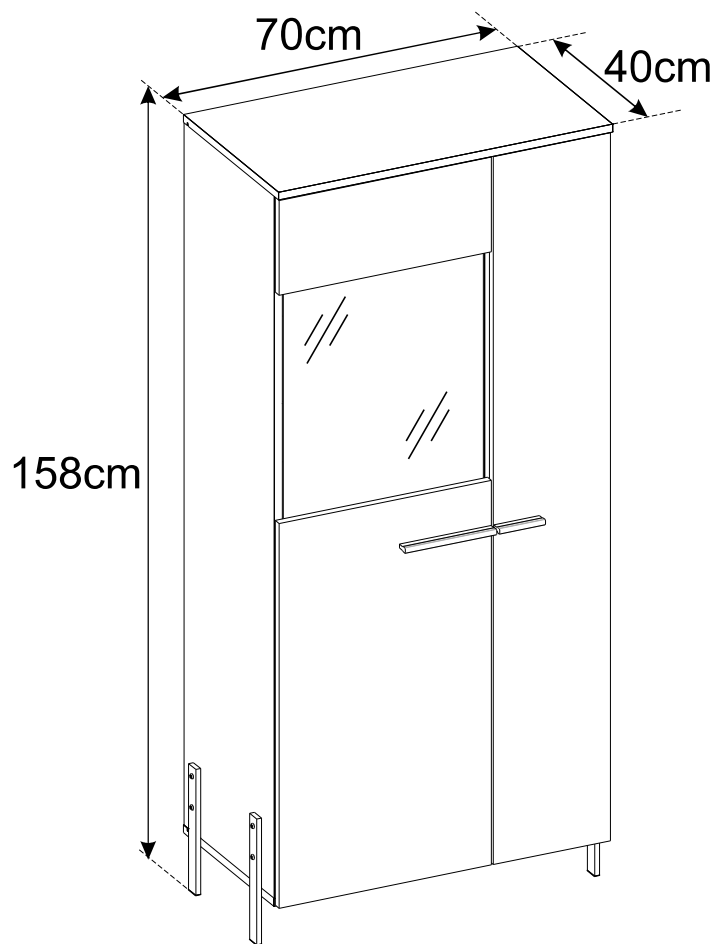
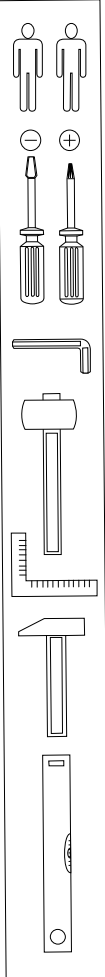
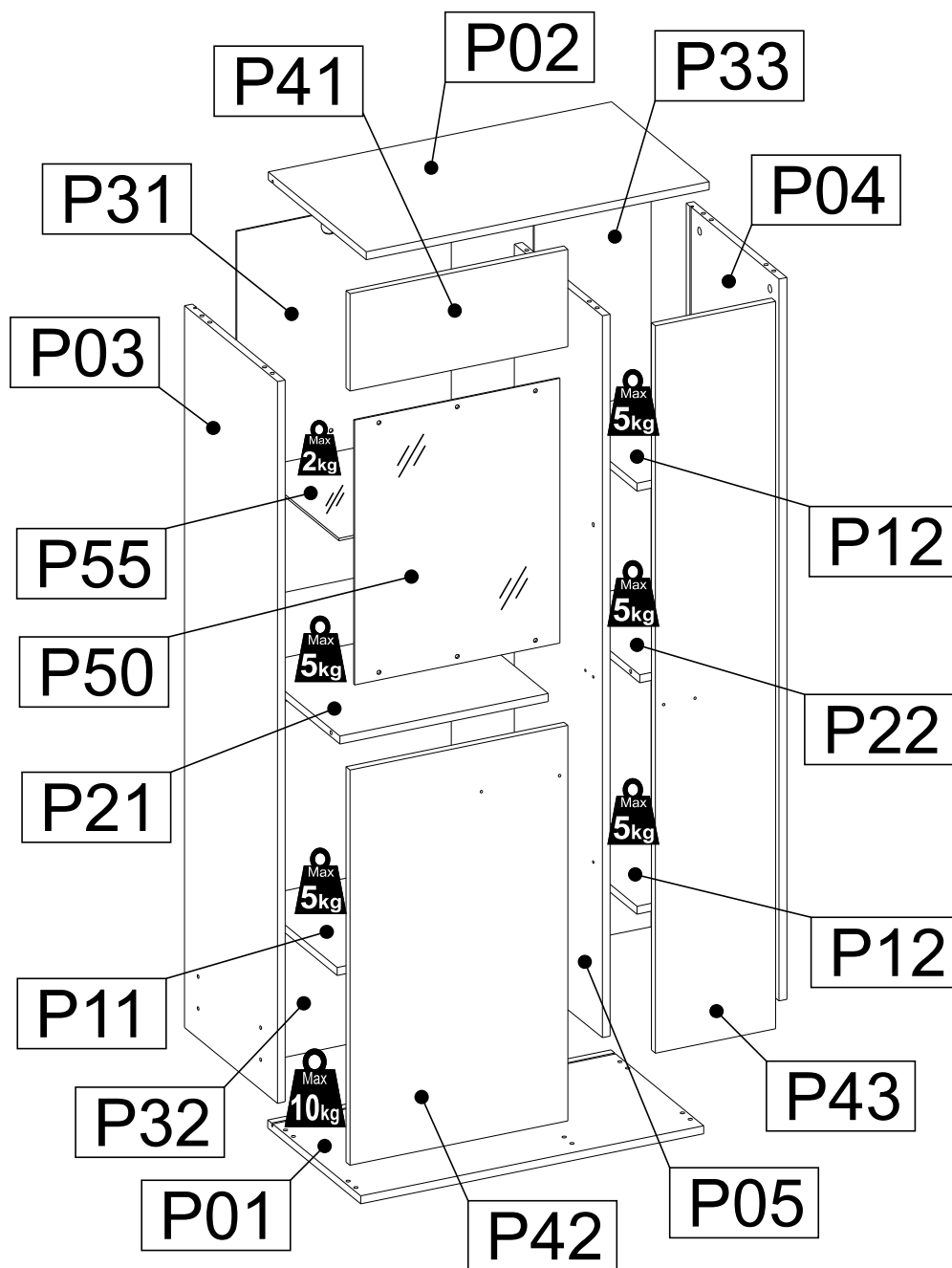
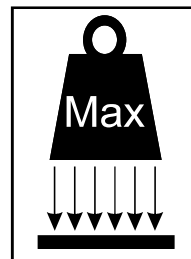

A	B (mm)	C (mm)	D (mm)	E	F
P01	702	380	16	1	2 2
P02	702	400	16	1	1 2
P03	1446	380	16	1	2 2
P04	1446	380	16	1	2 2
P05	1446	360	16	1	2 2
P11	426	350	16	1	1 2
P12	226	350	16	2	1 2
P21	426	360	16	1	2 2
P22	226	360	16	1	2 2
P31	743	439	3	1	1 2
P32	713	439	3	1	1 2
P33	1456	239	3	1	2 2
P41	195	446	16	1	1 2
P42	792	446	16	1	1 2
P43	1457	246	16	1	2 2
P50	530	420	4	1	1 2
P55	419	350	5	1	1 2

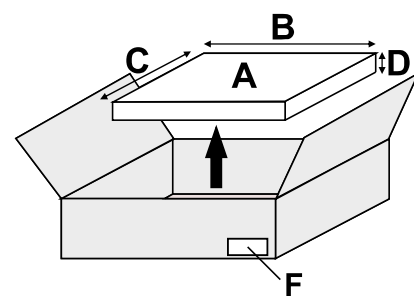

# 1

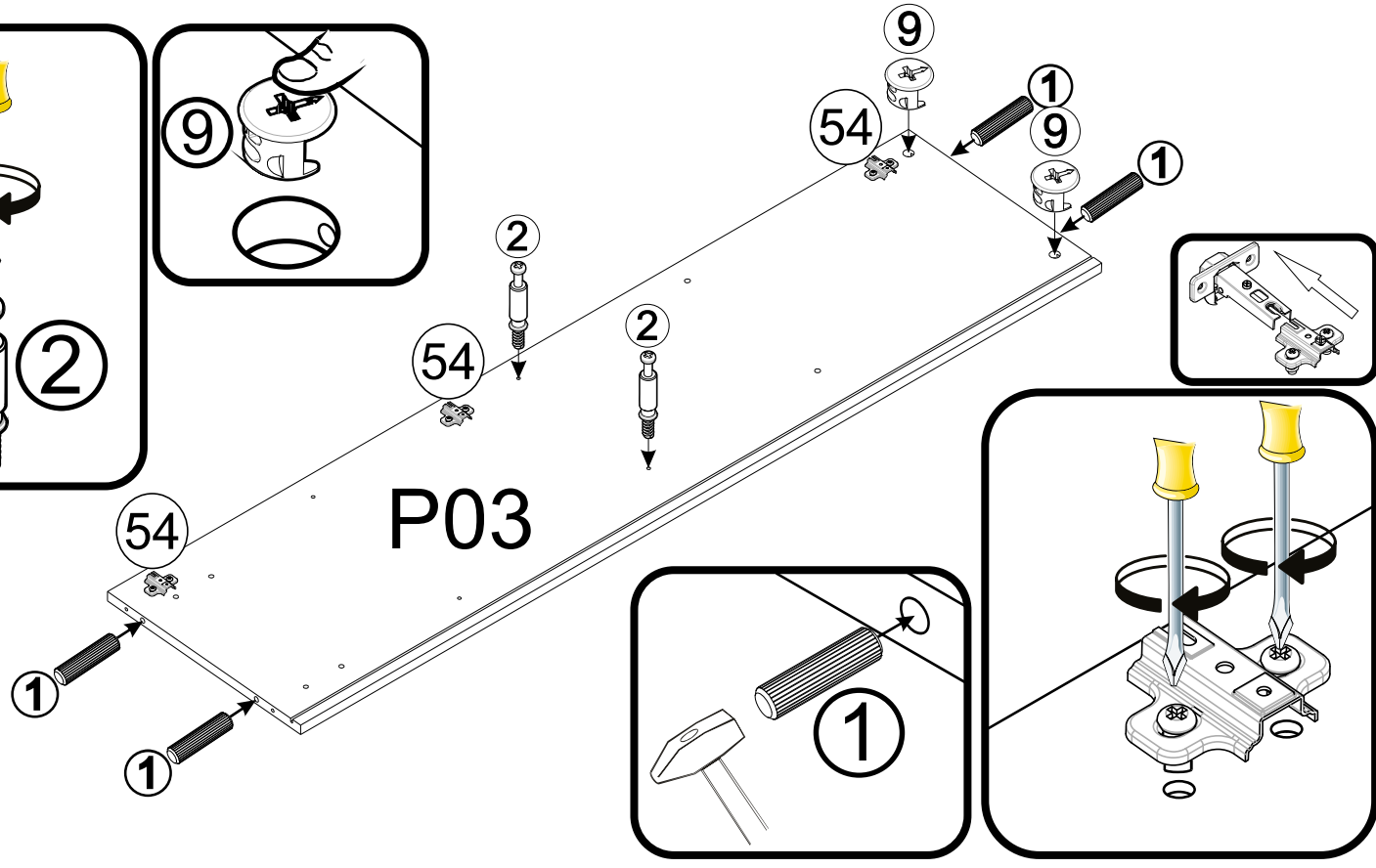
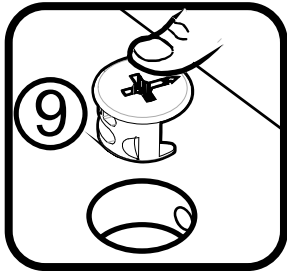
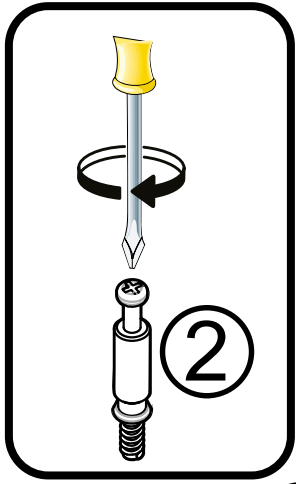
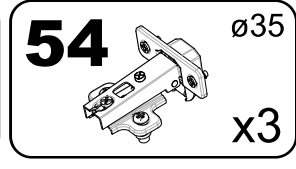
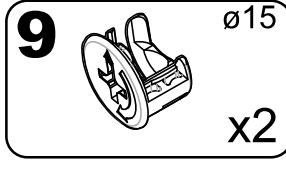
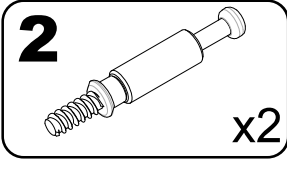
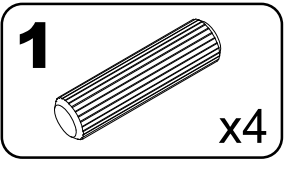

# 2

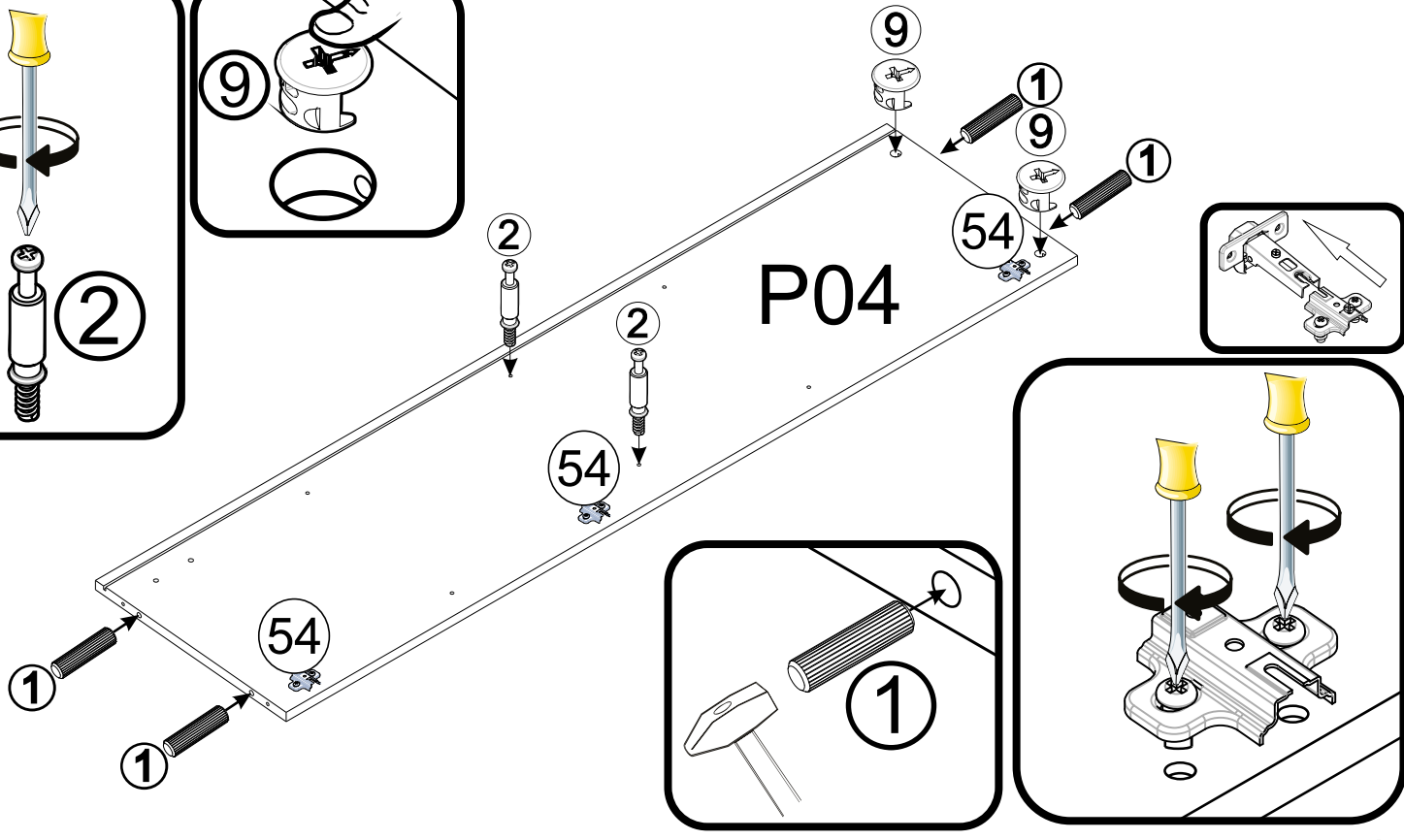
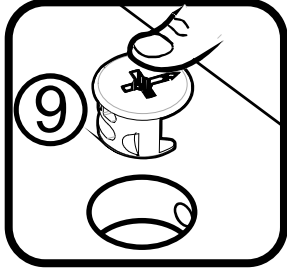
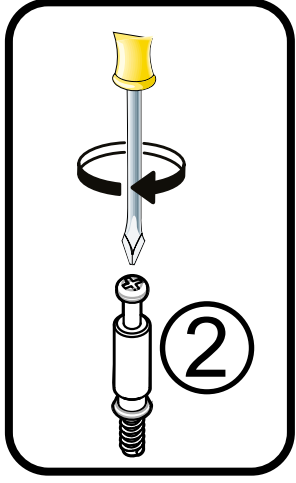
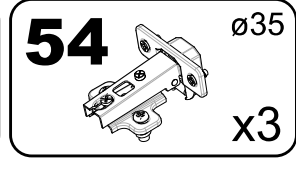
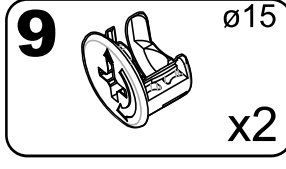
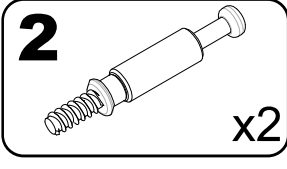
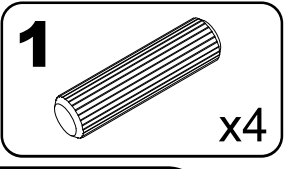

3

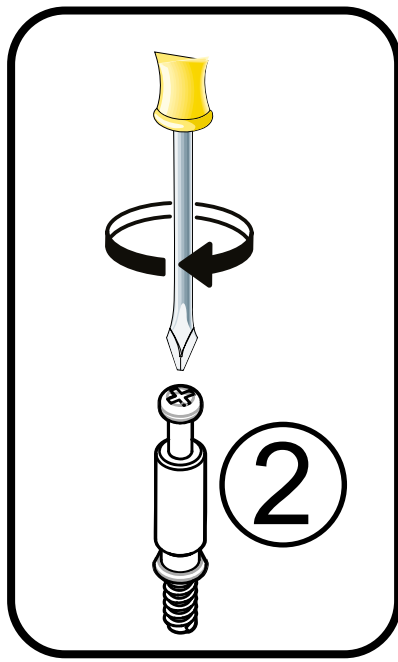
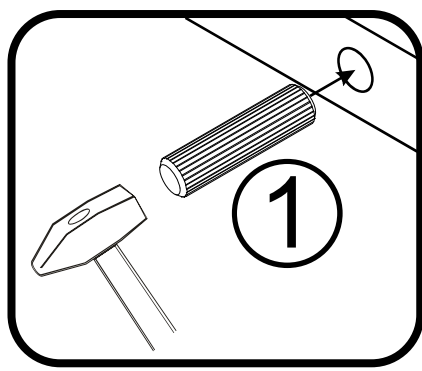
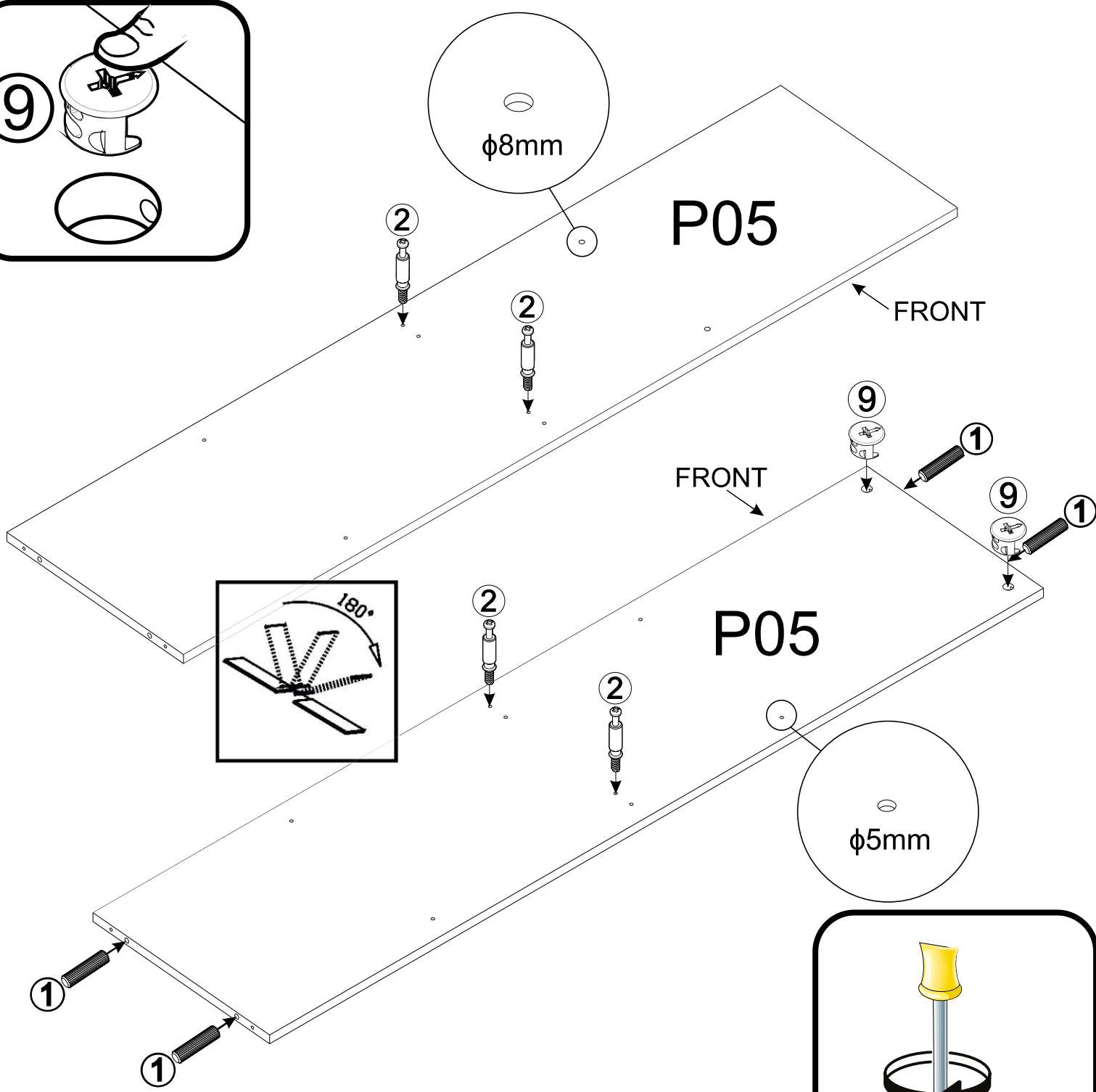
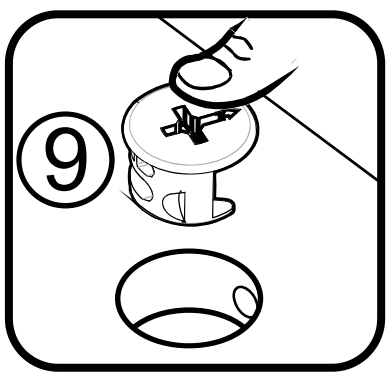
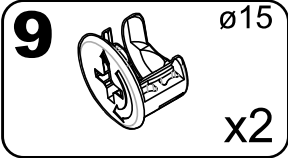
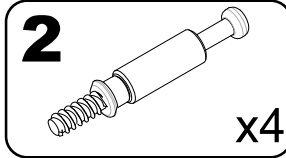
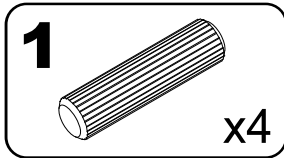

4

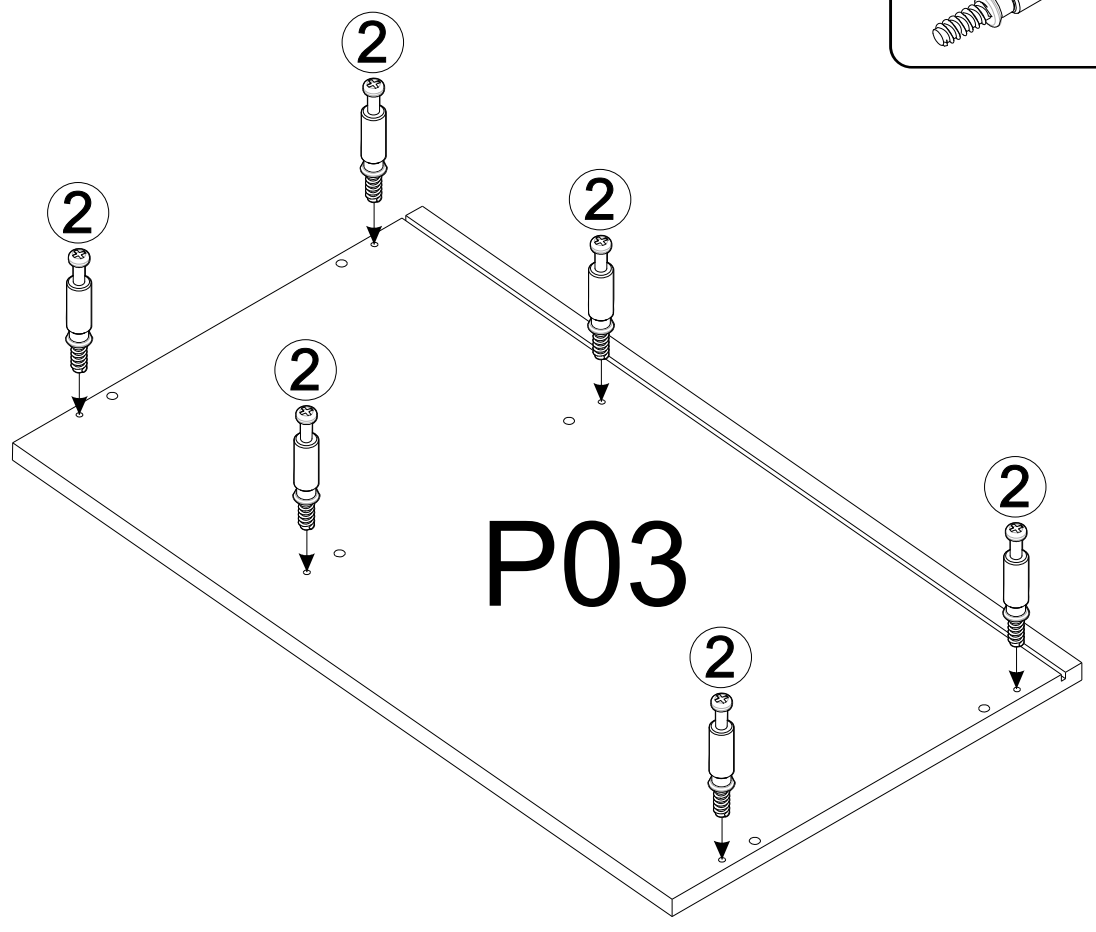
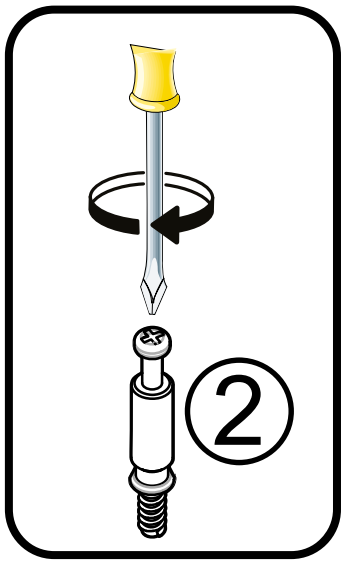
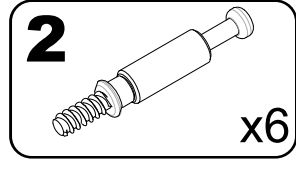

5

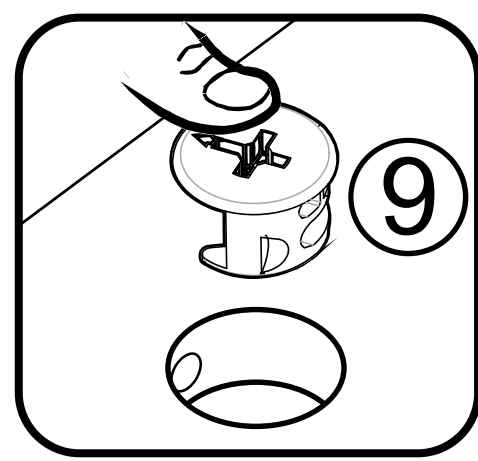
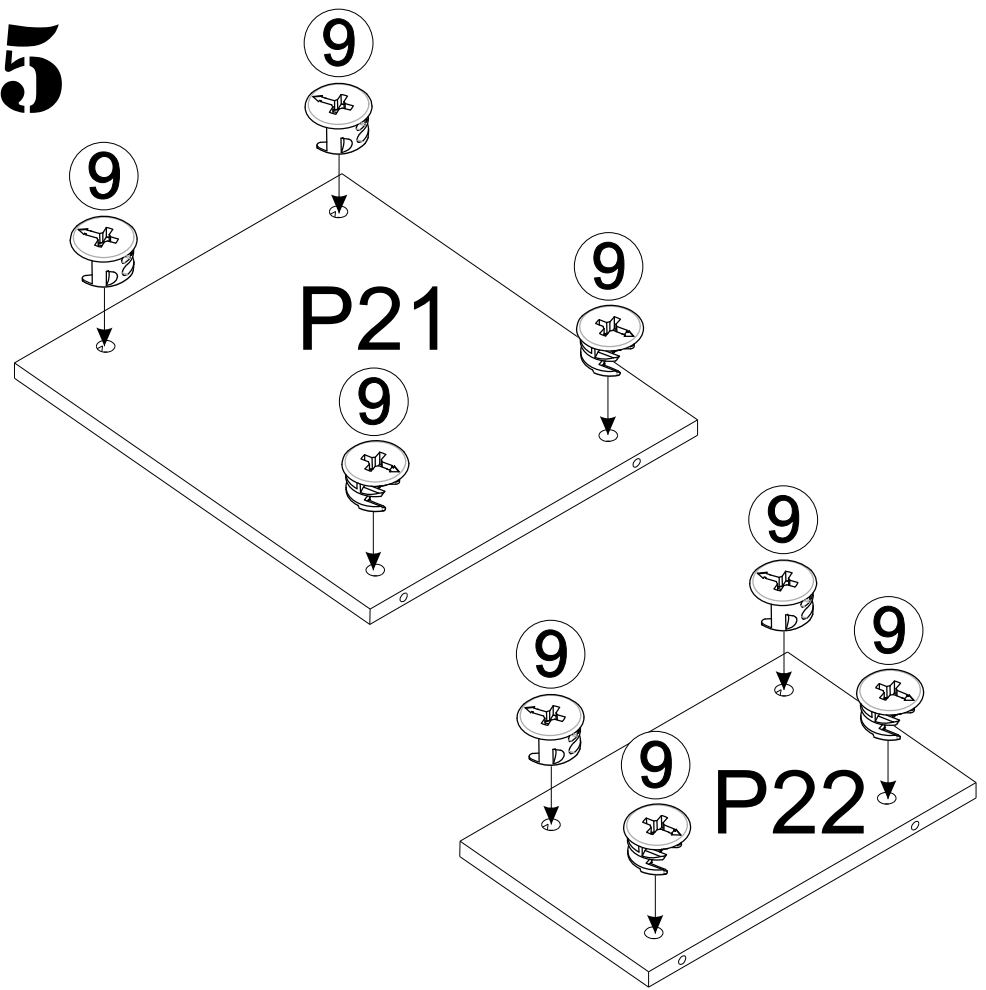
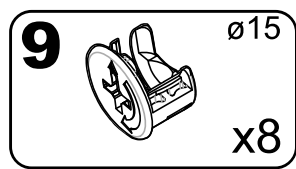

6

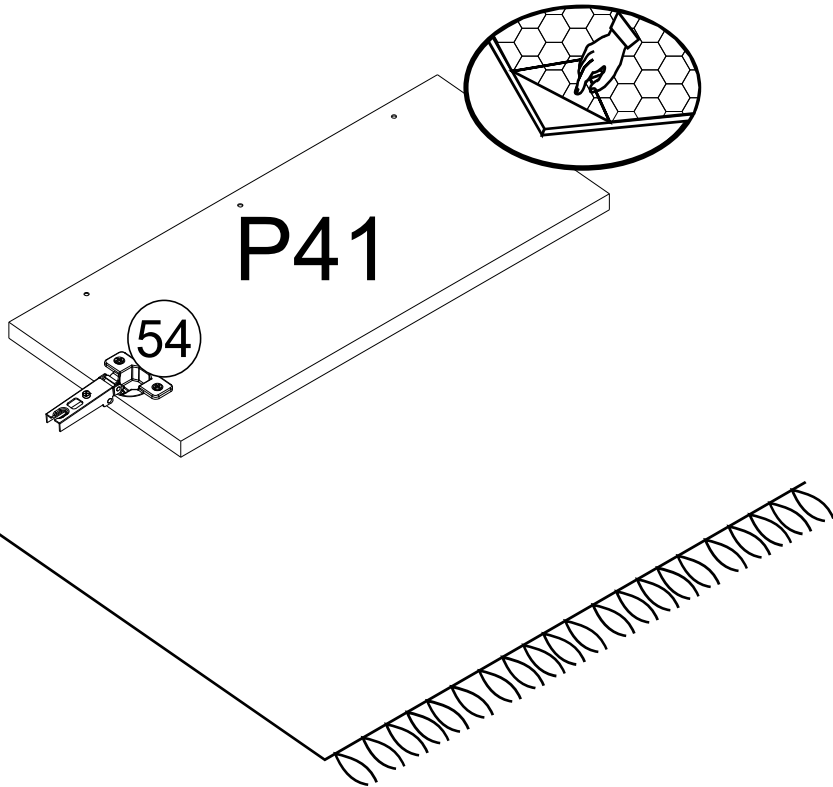
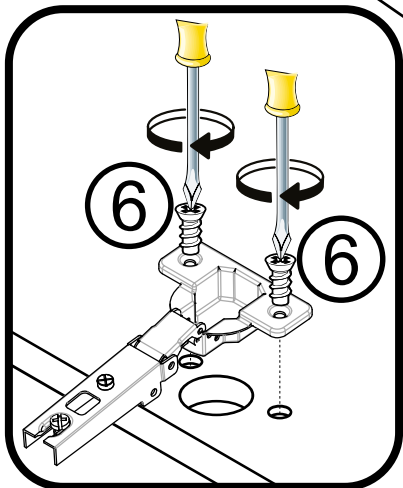
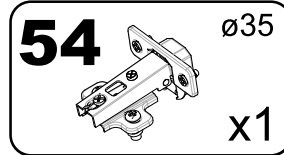
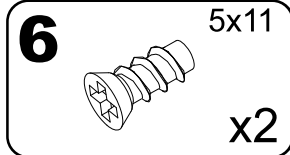

7

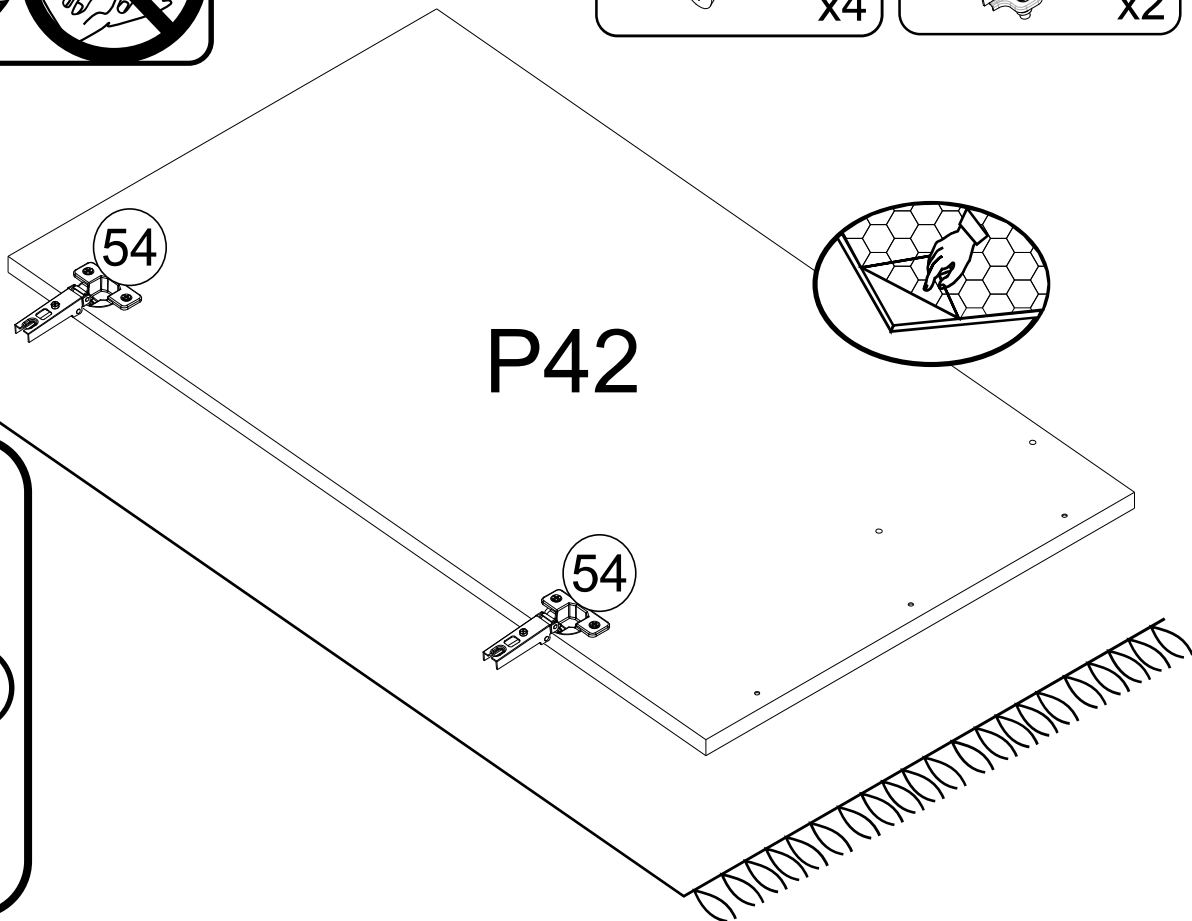
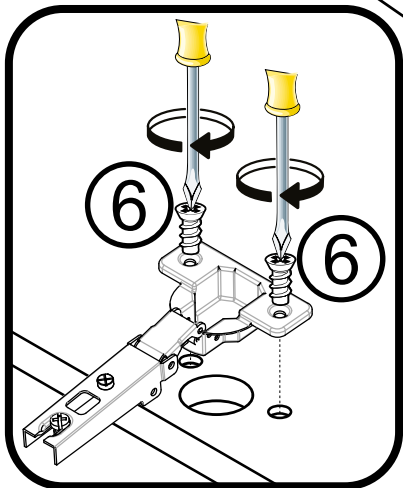
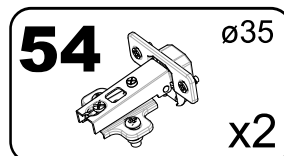
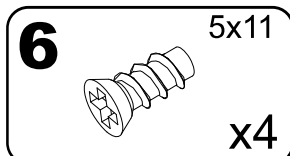
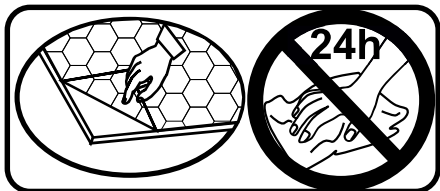

8

**6** 5x11  
x6

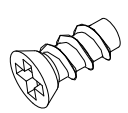

**54**  $\varnothing 35$   
x3

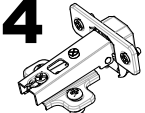
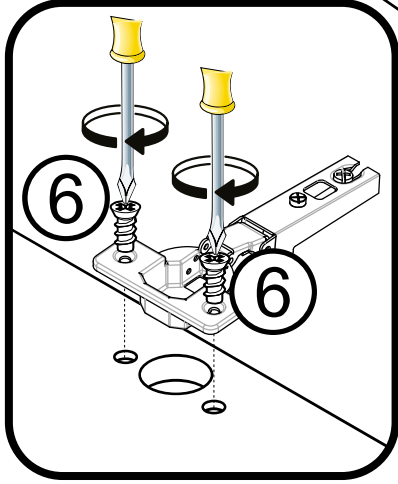
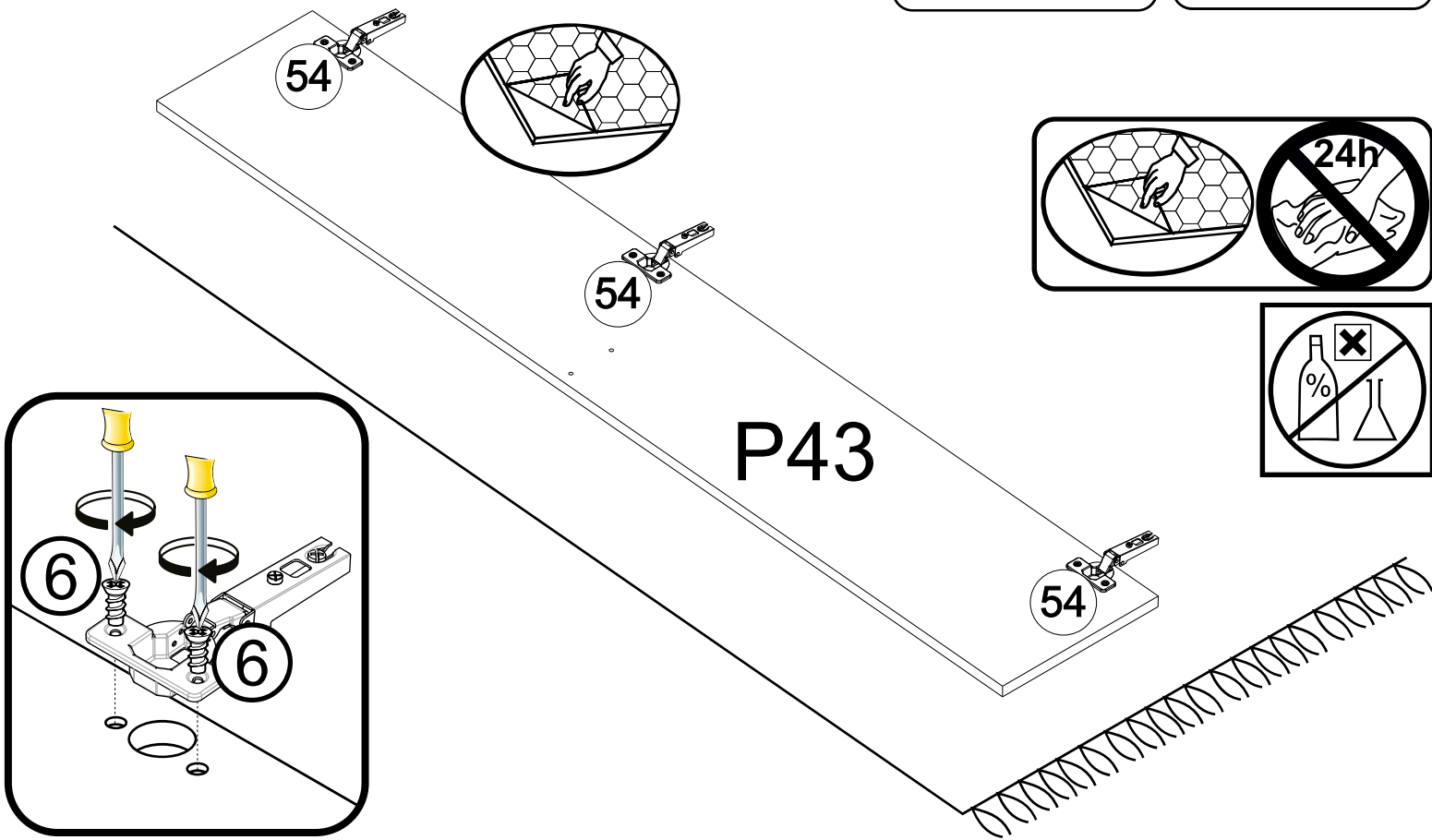

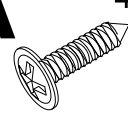

9

**4A** 4x16  
x6

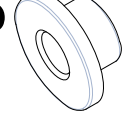
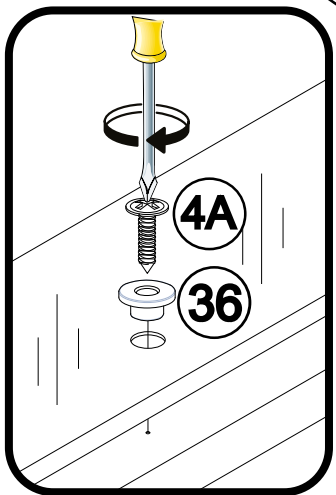
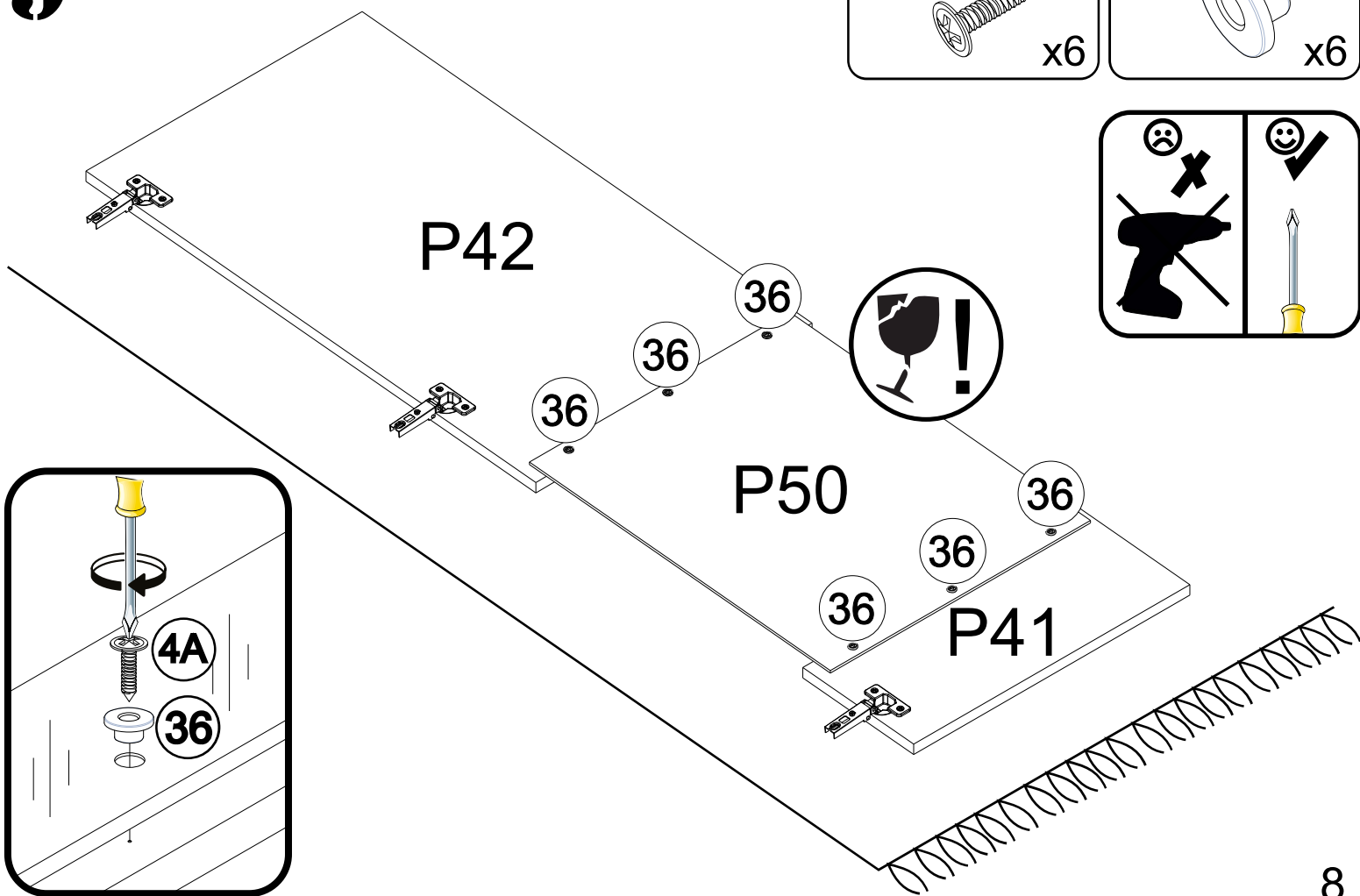

**36**  
x6





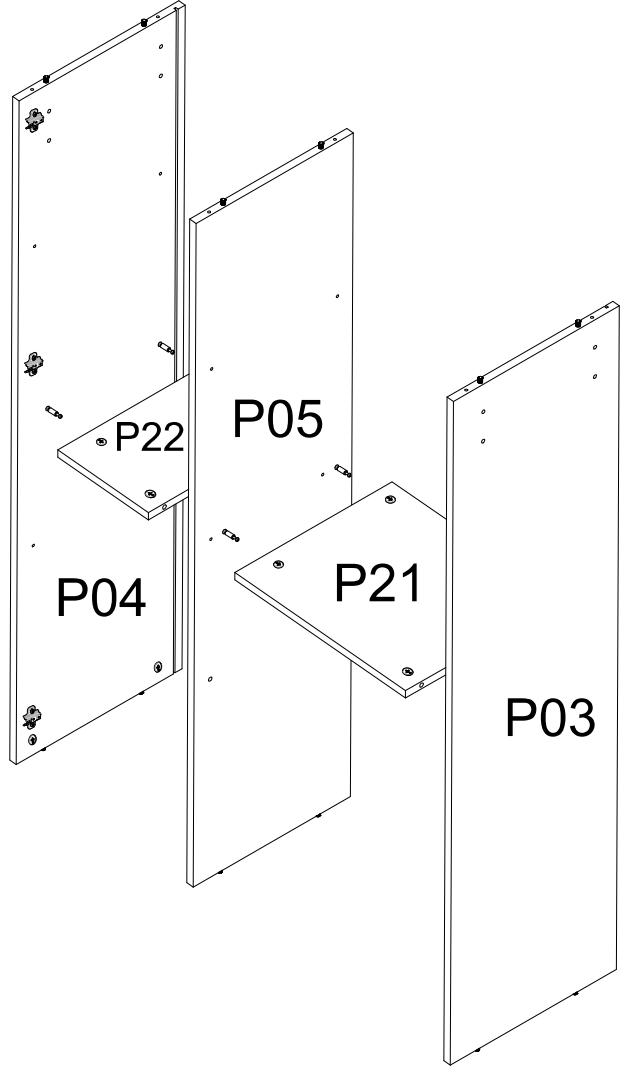

# 10

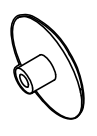

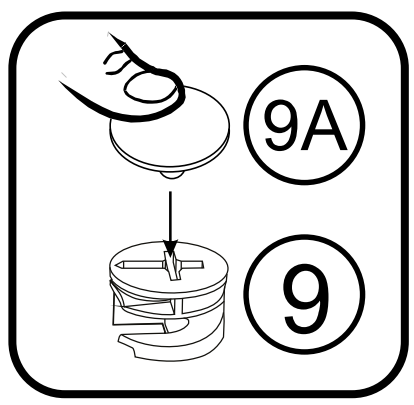
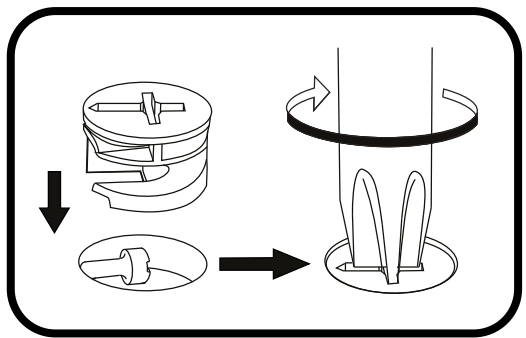
**9A**  x8



# 11

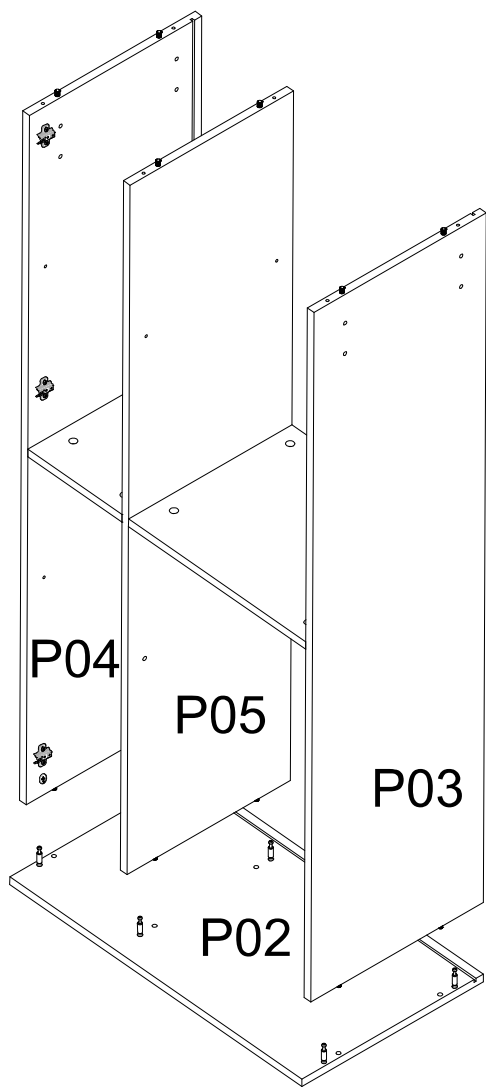

**9A**  x6

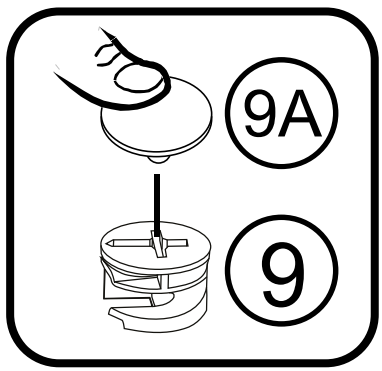
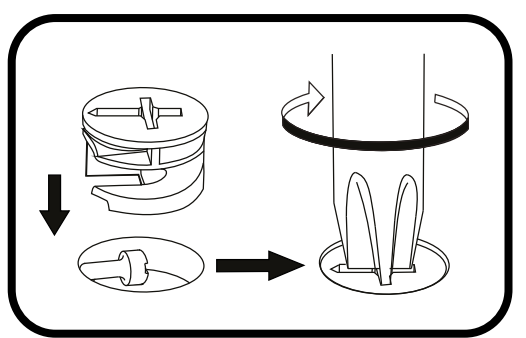

# 12

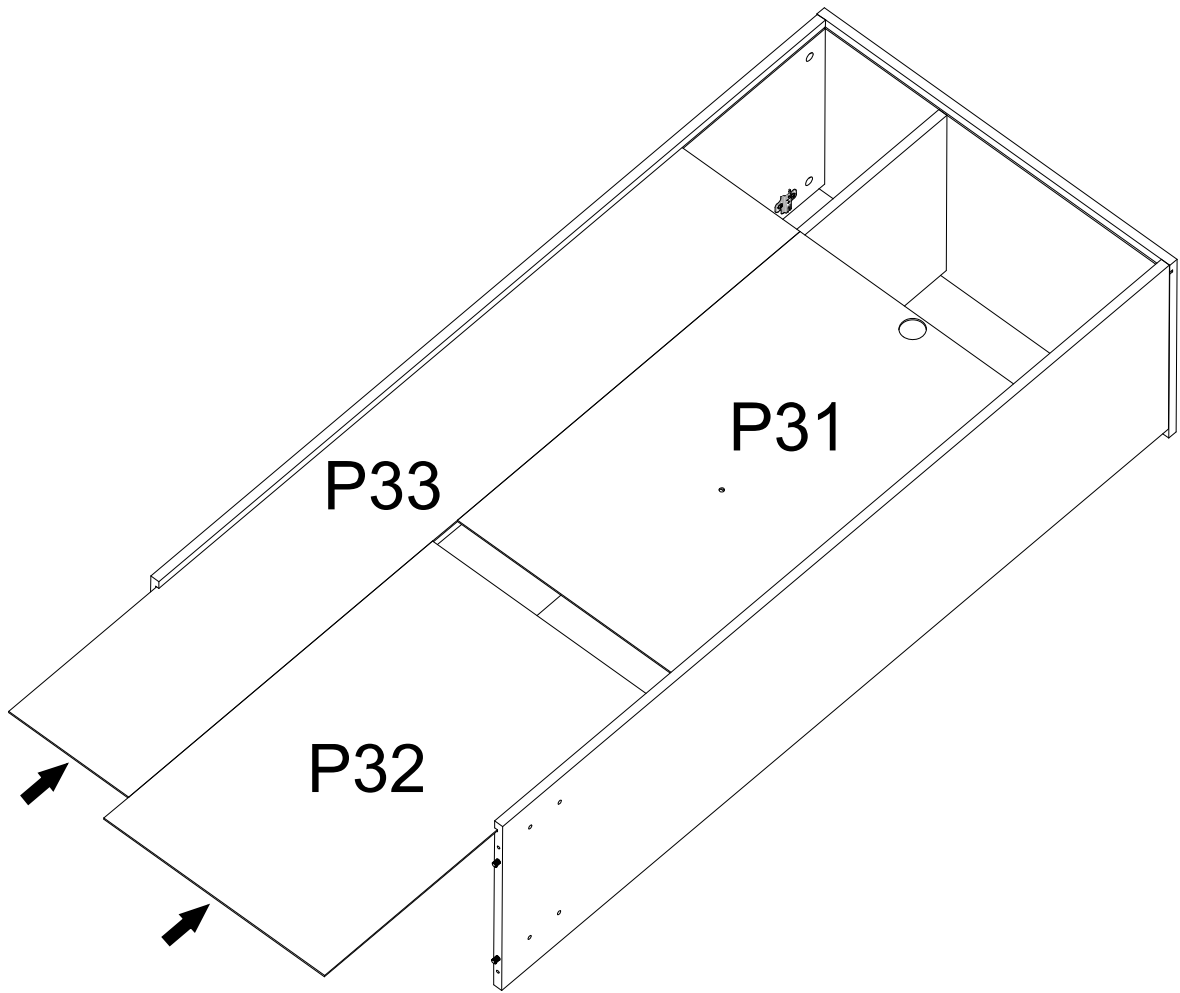

# 13

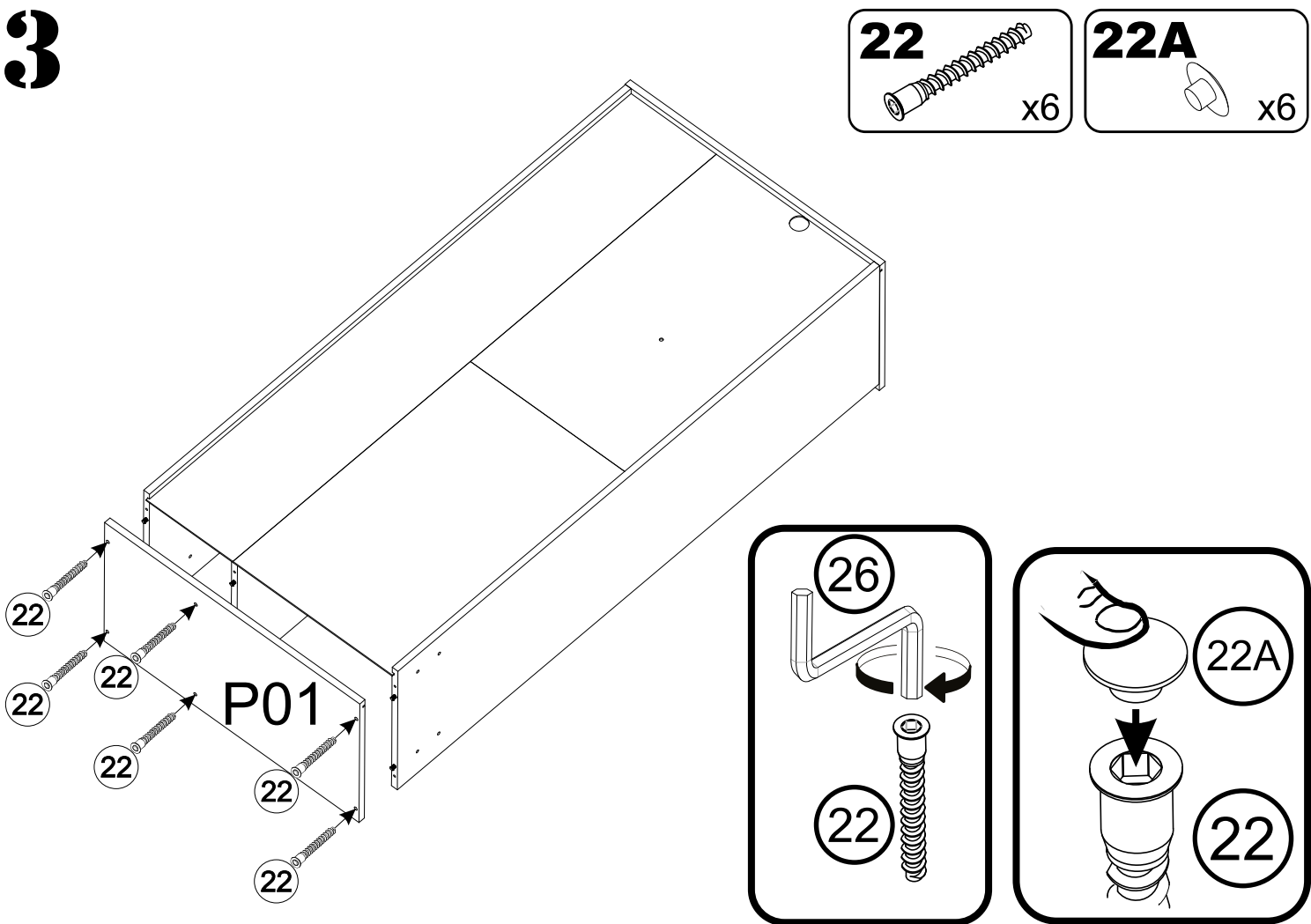

# 14

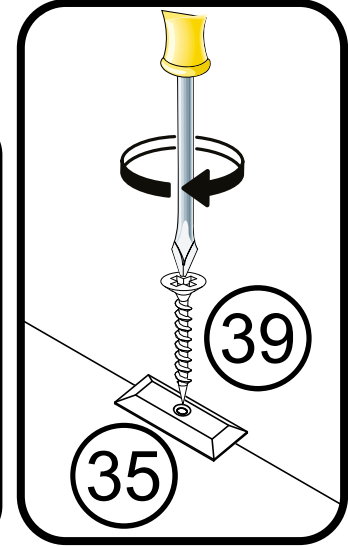
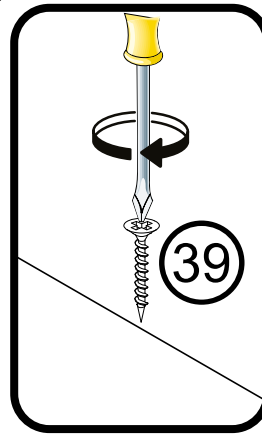
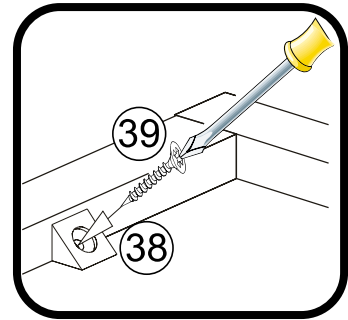
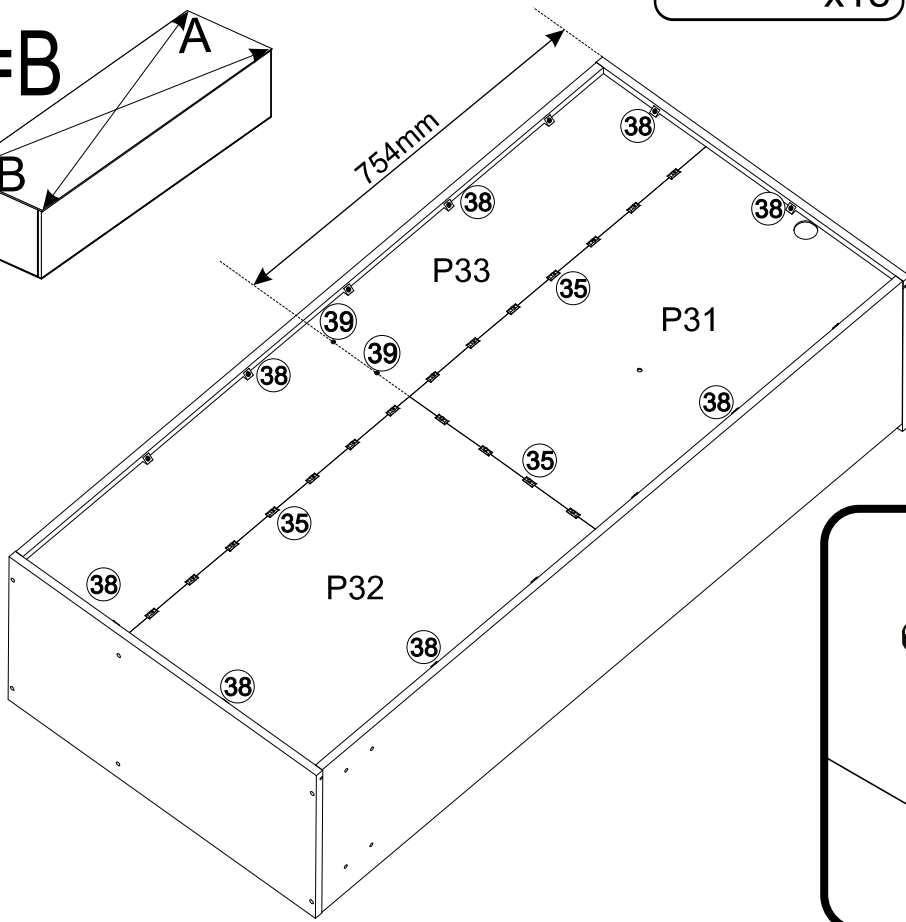
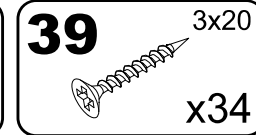
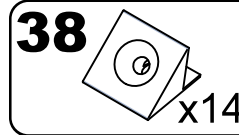
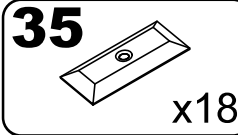
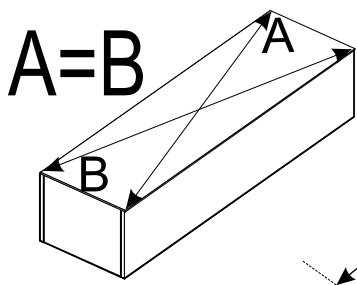

# 15

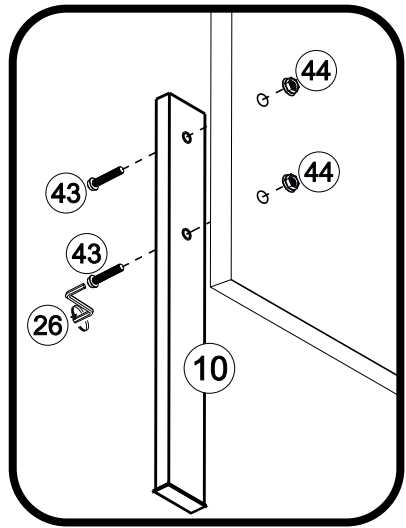
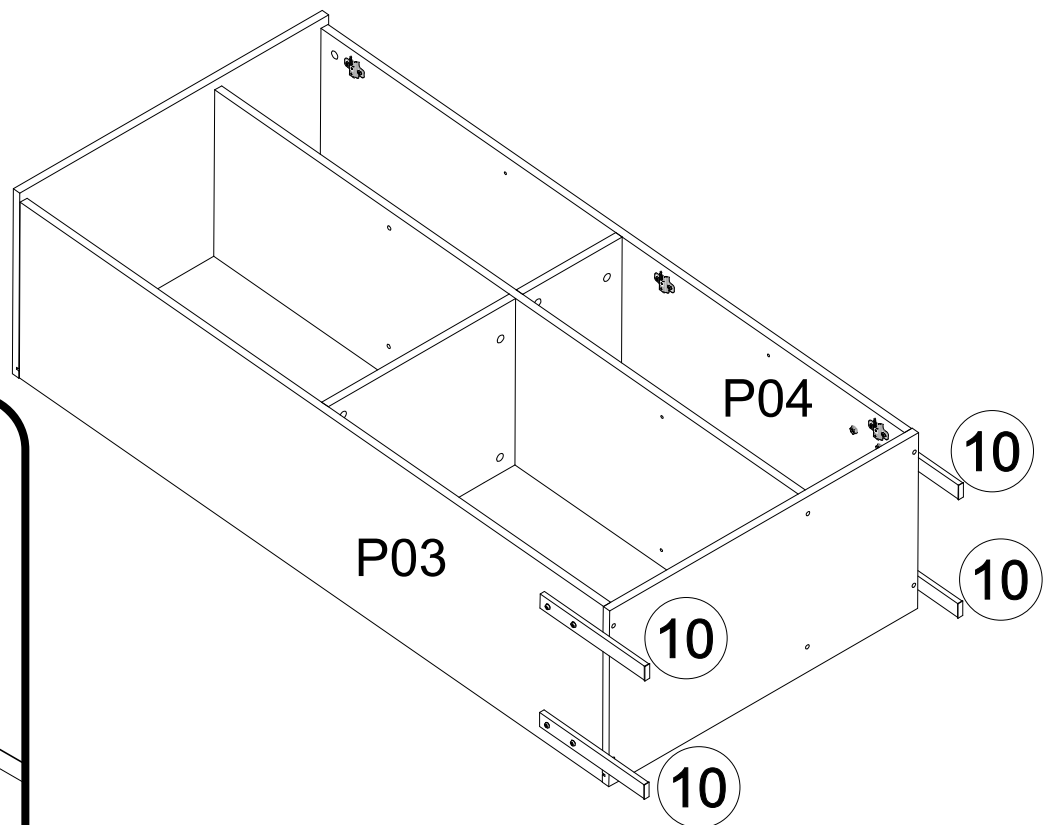
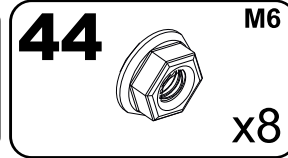
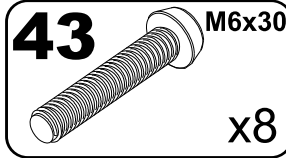
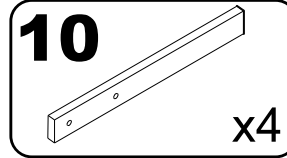

# 16

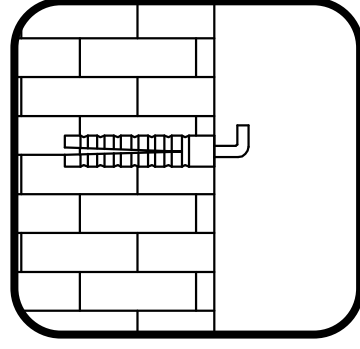
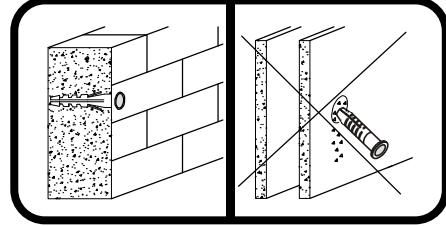
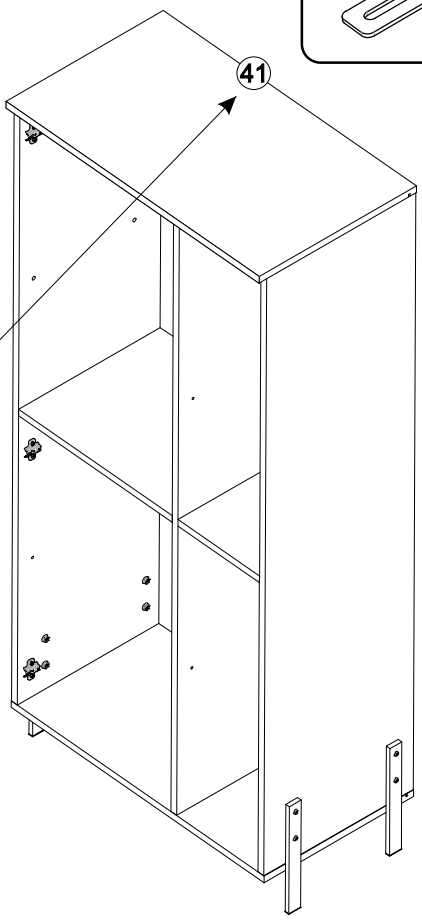
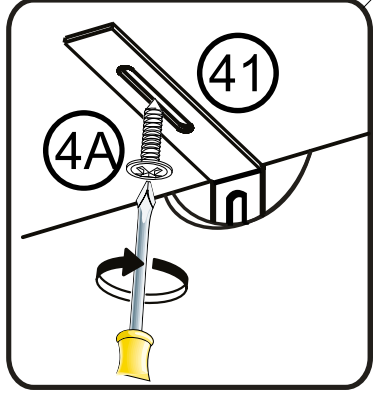
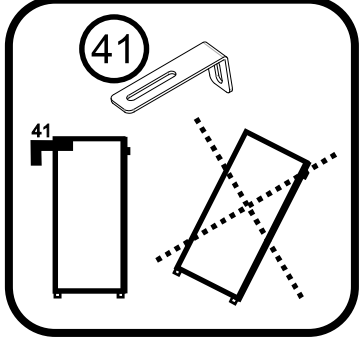
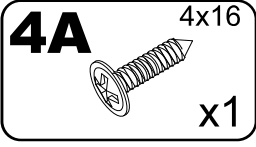
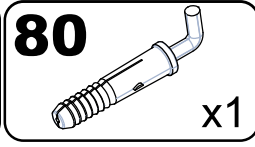
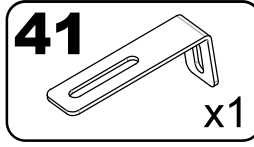

# 17

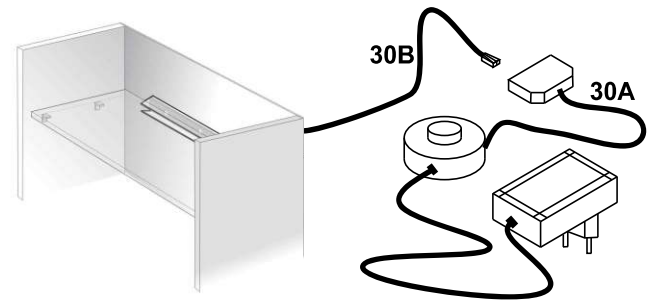
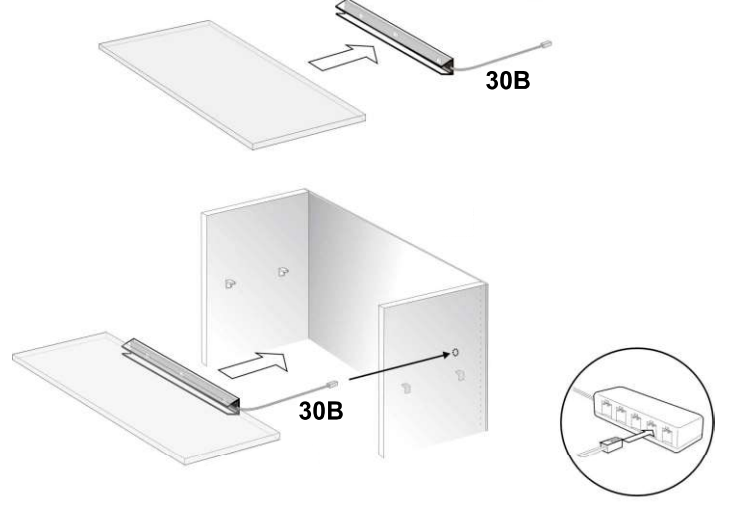
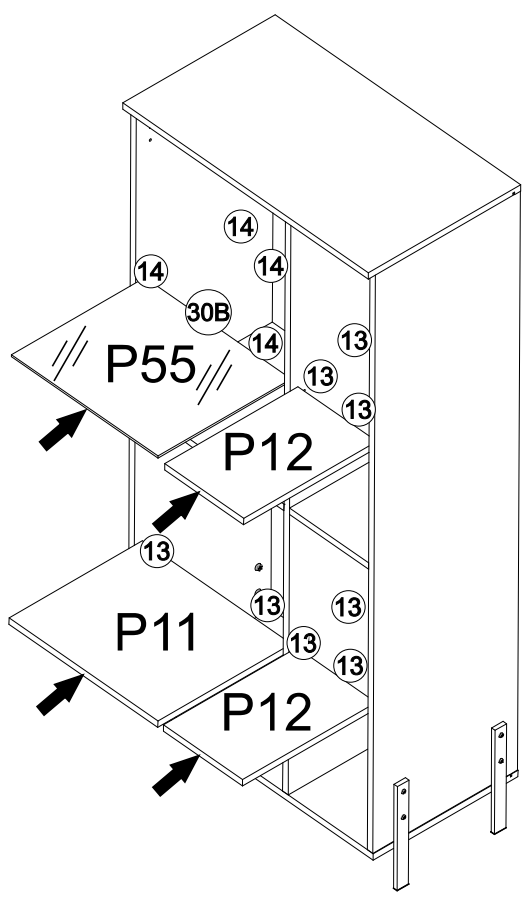
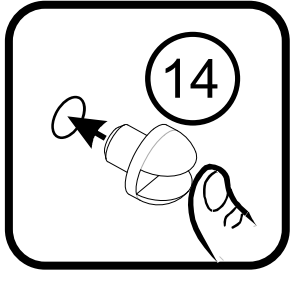
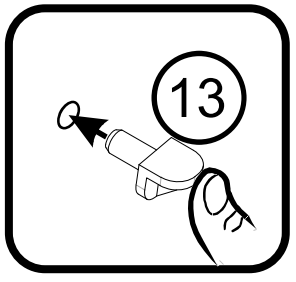
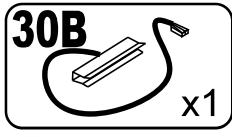
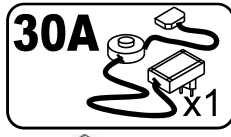
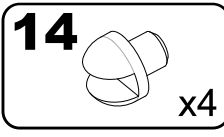
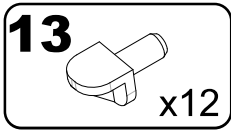

# 17

