

XXXXXXXXXXXX  
 serie: xxx  
 .....  
 Hergestellt für:  
 .....  
 .....

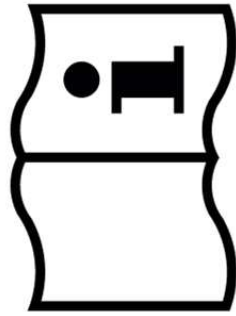

60 min

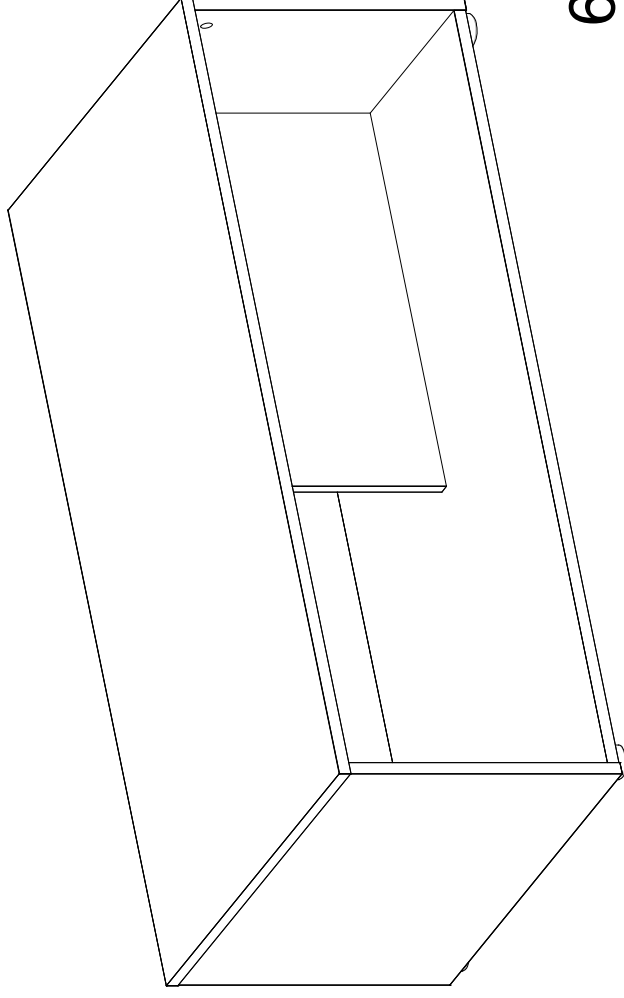

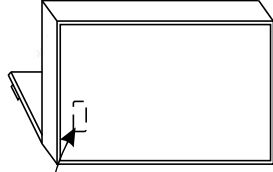
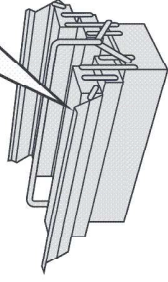
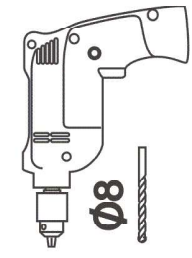
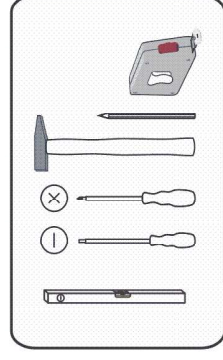
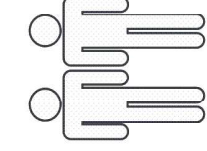
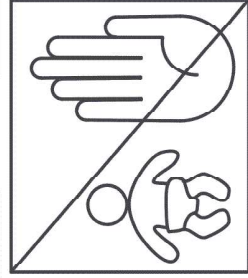
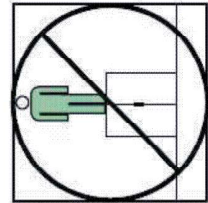
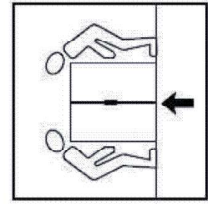
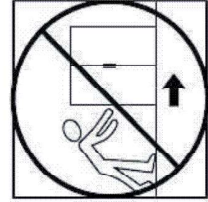
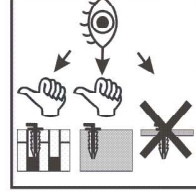
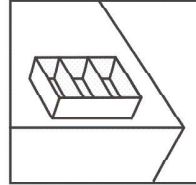
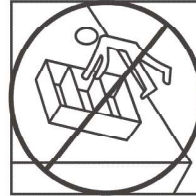
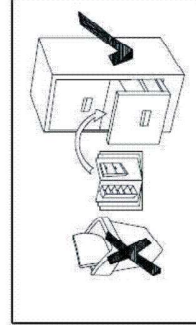
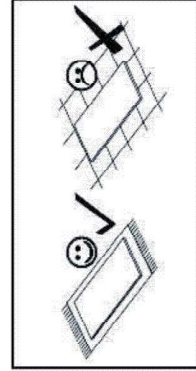
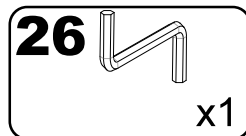
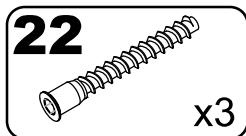
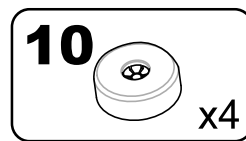
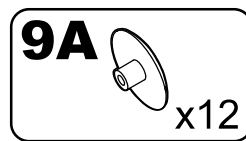
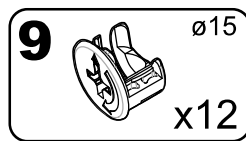
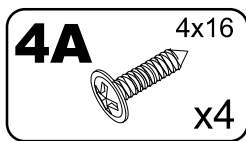
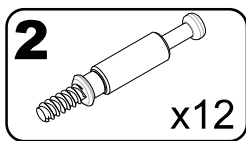
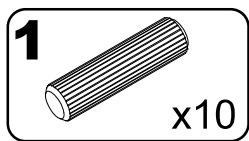
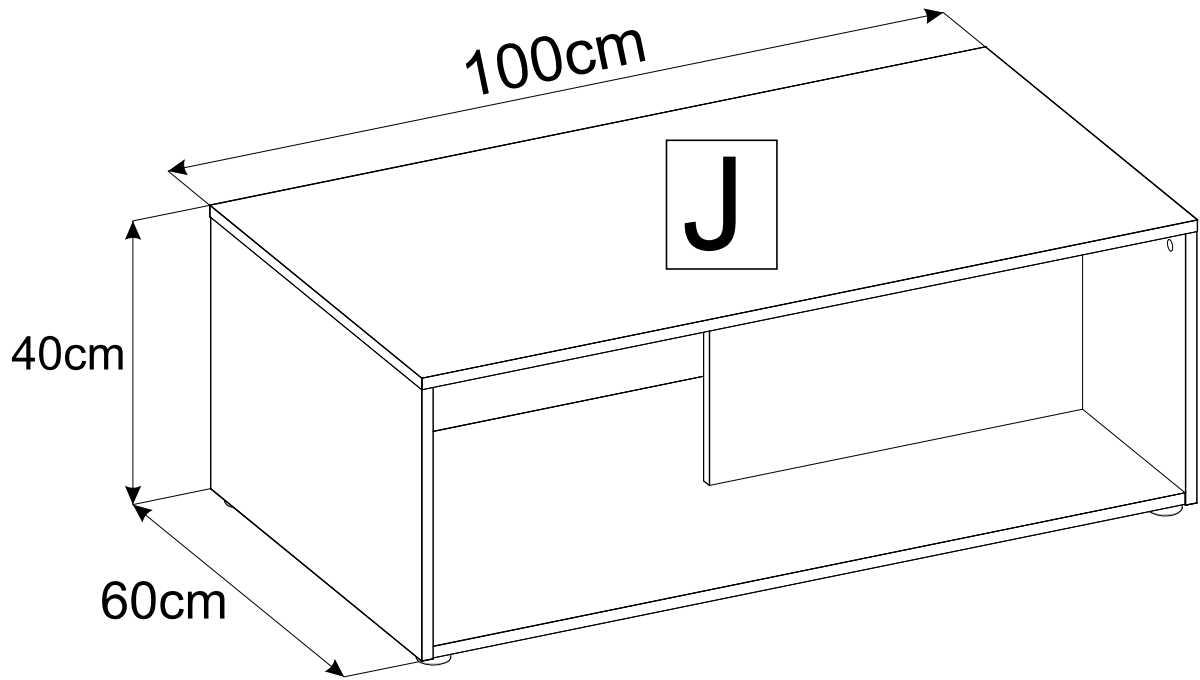
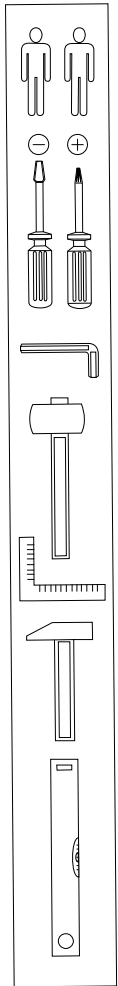

J

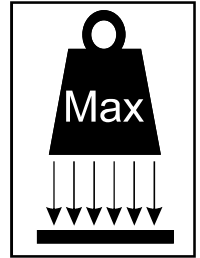
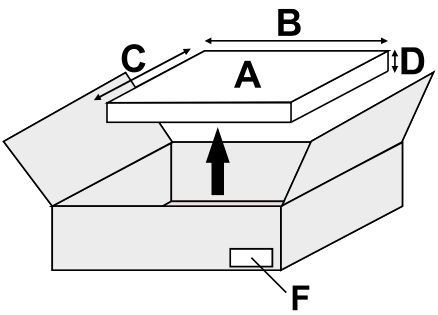
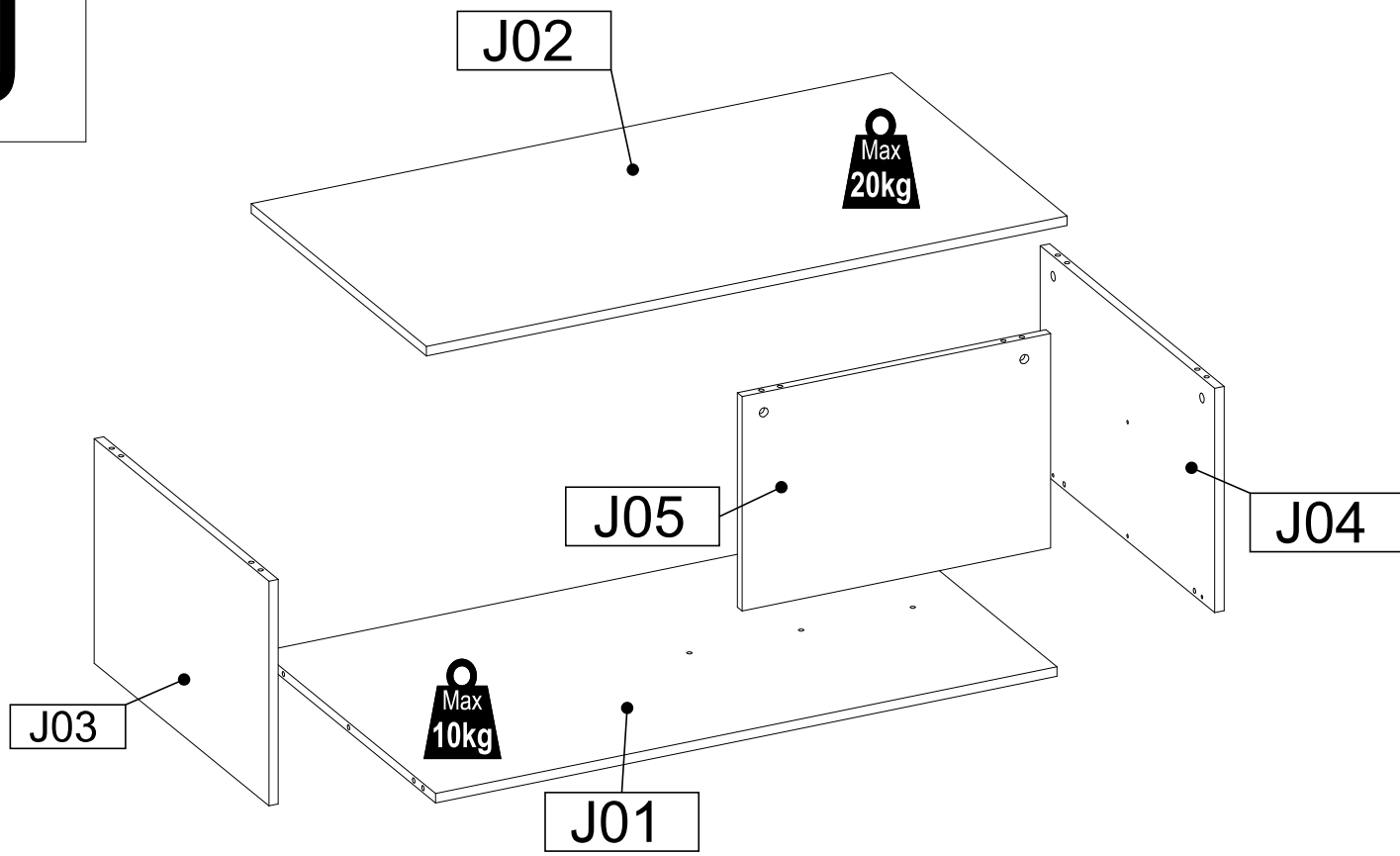

A	B (mm)	C (mm)	D (mm)	E	F
J01	1068	598	16	1	1 1
J02	1101	602	16	1	1 1
J03	378	600	16	1	1 1
J04	378	600	16	1	1 1
J05	530	361	16	1	1 1

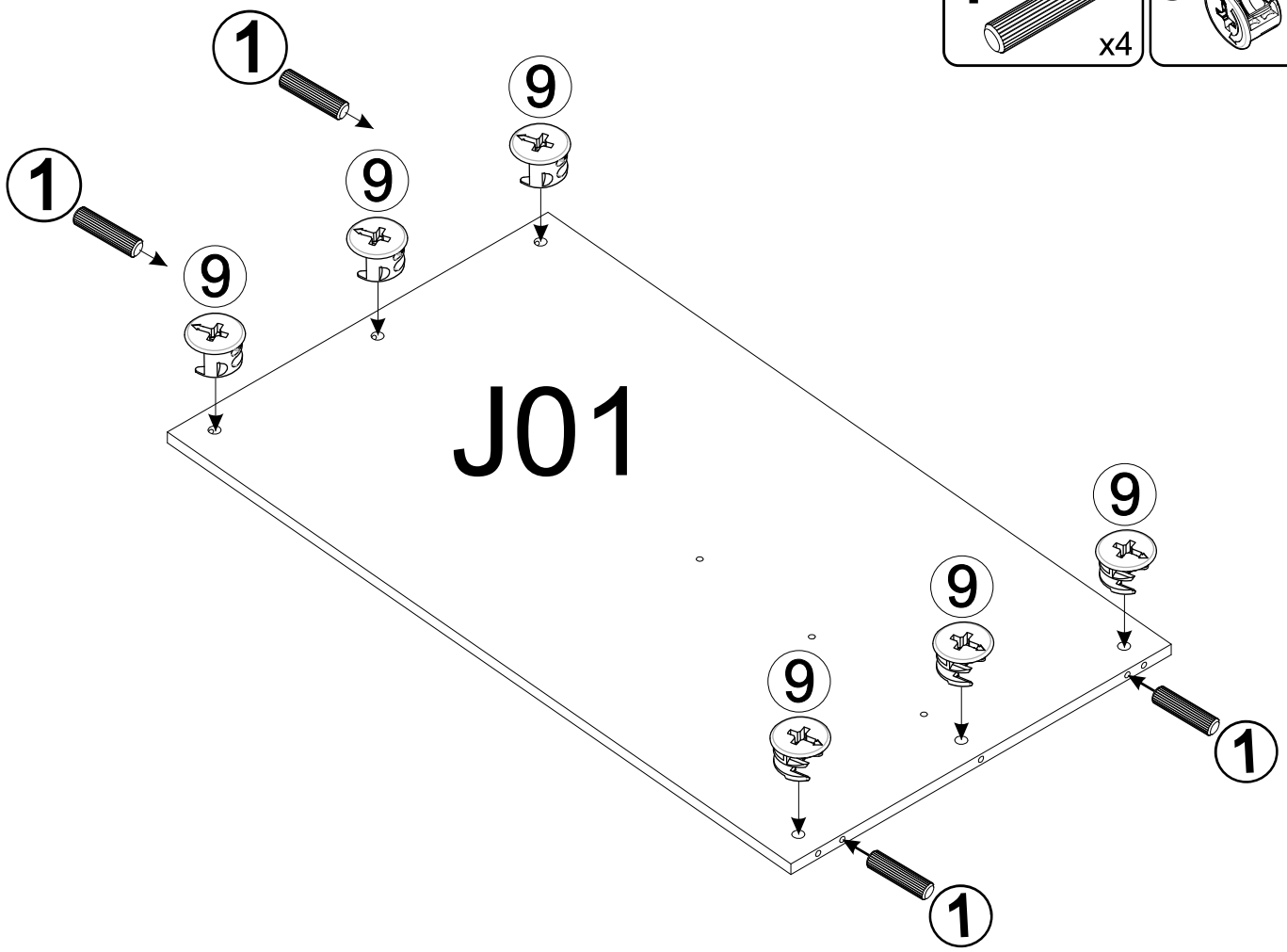
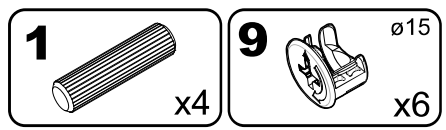

# 1

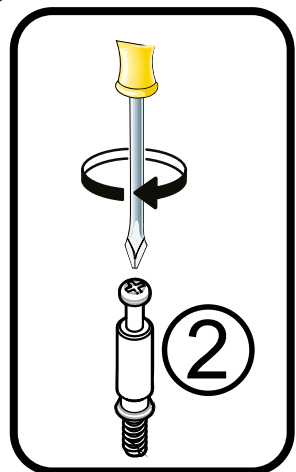
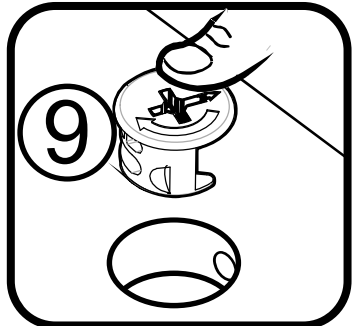
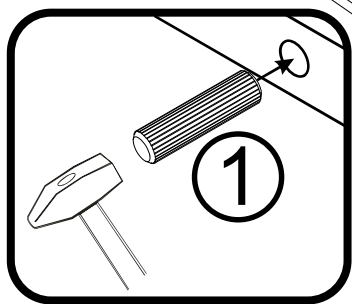
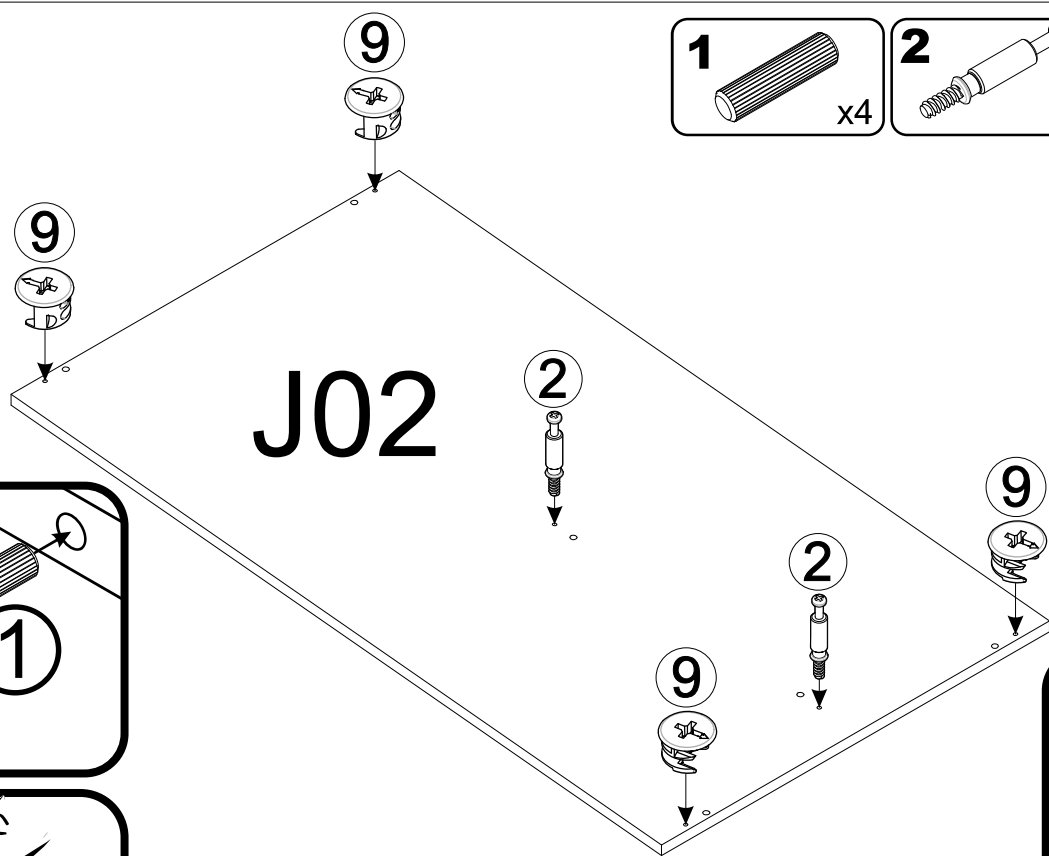
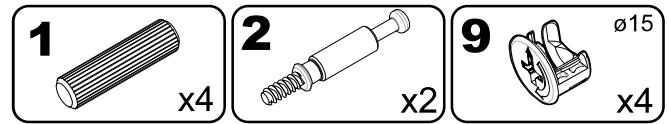

# 2



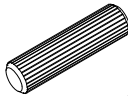
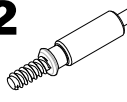

# 3

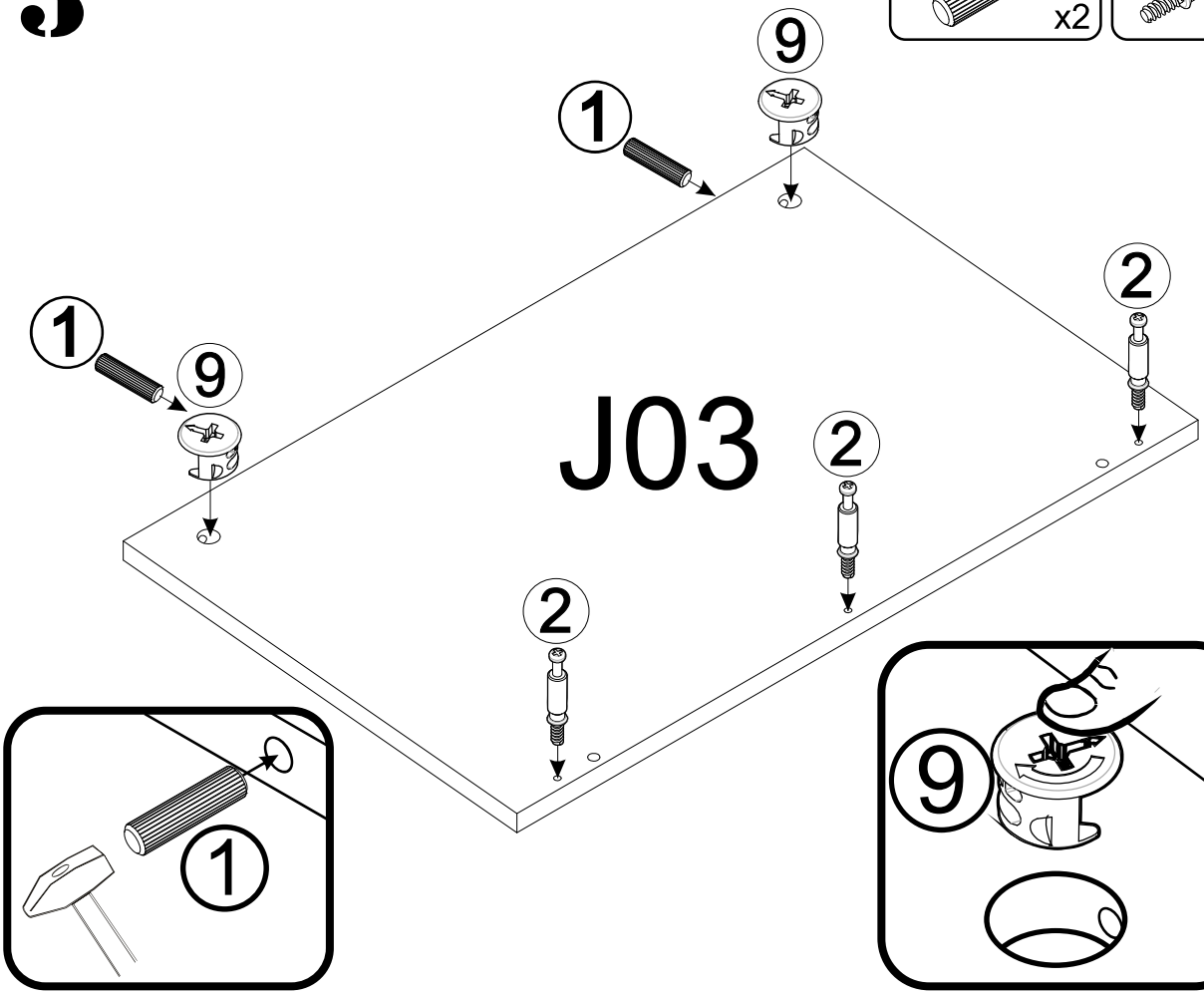
- 1**  x2
- 2**  x3
- 9**   $\varnothing 15$  x2

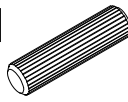
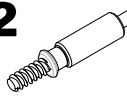

# 4

- 1**  x2
- 2**  x3
- 9**   $\varnothing 15$  x2

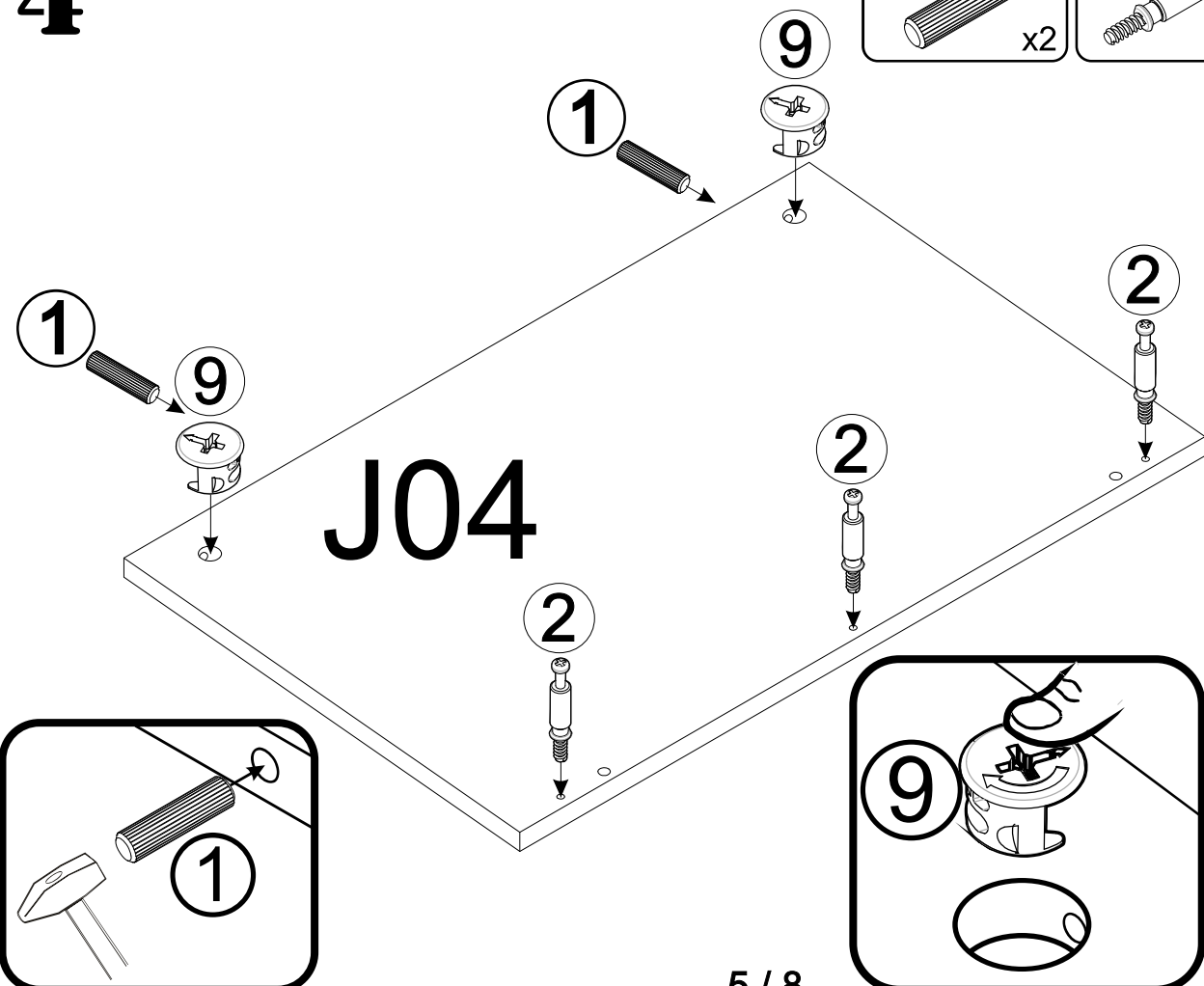

5

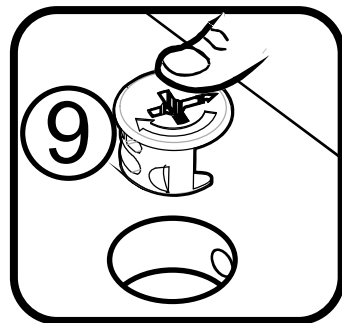
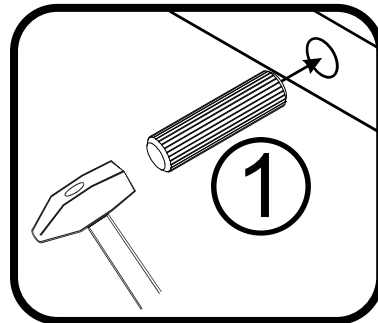
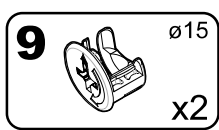
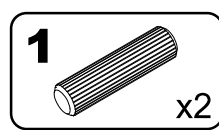
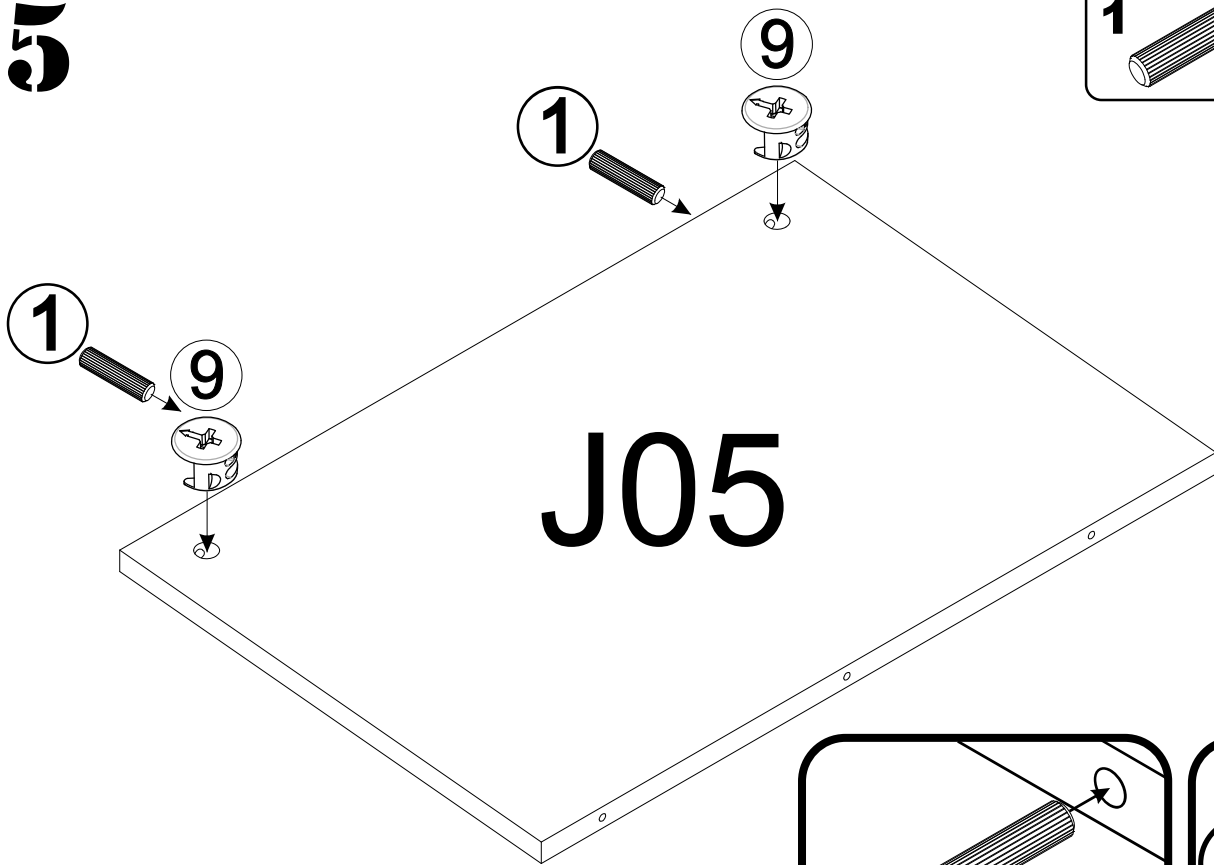

6

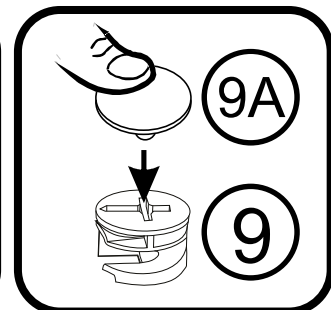
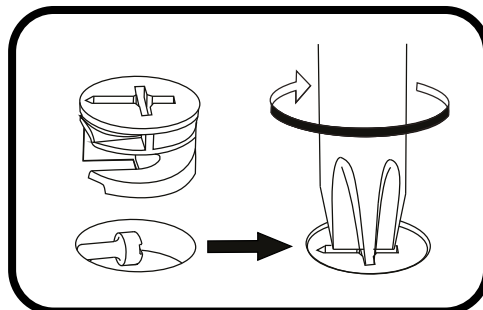
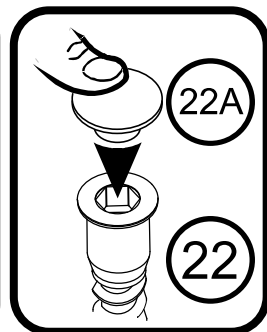
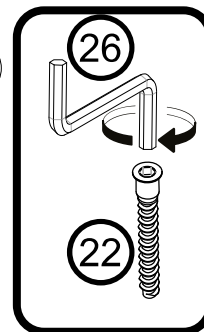
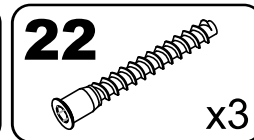
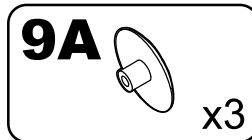
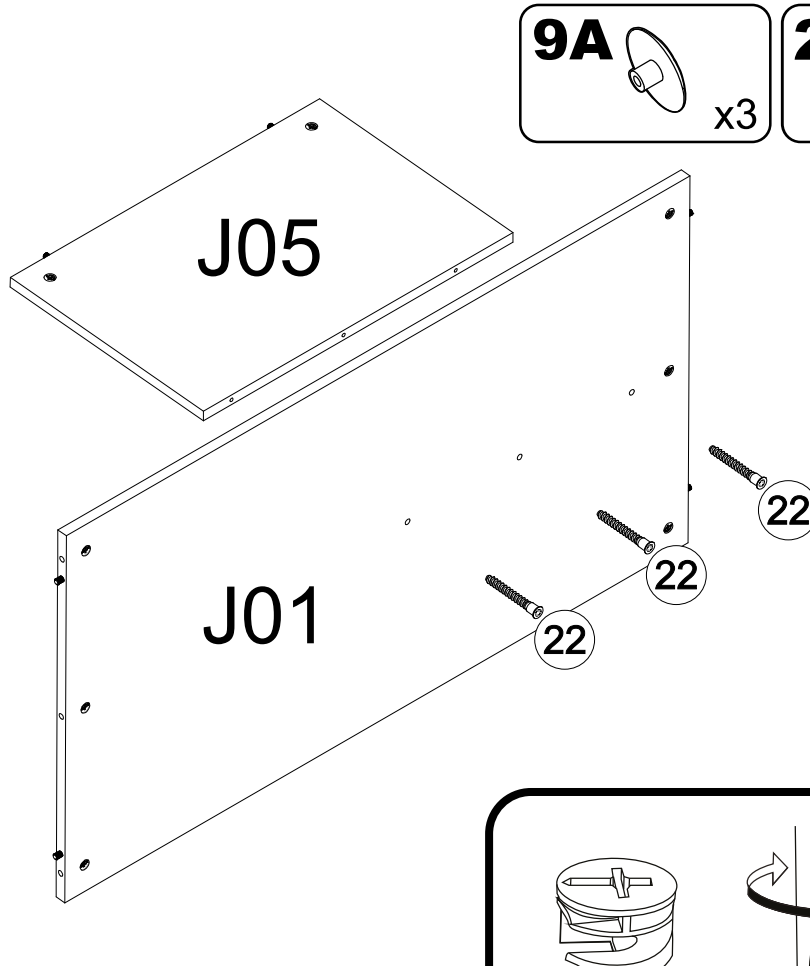

7

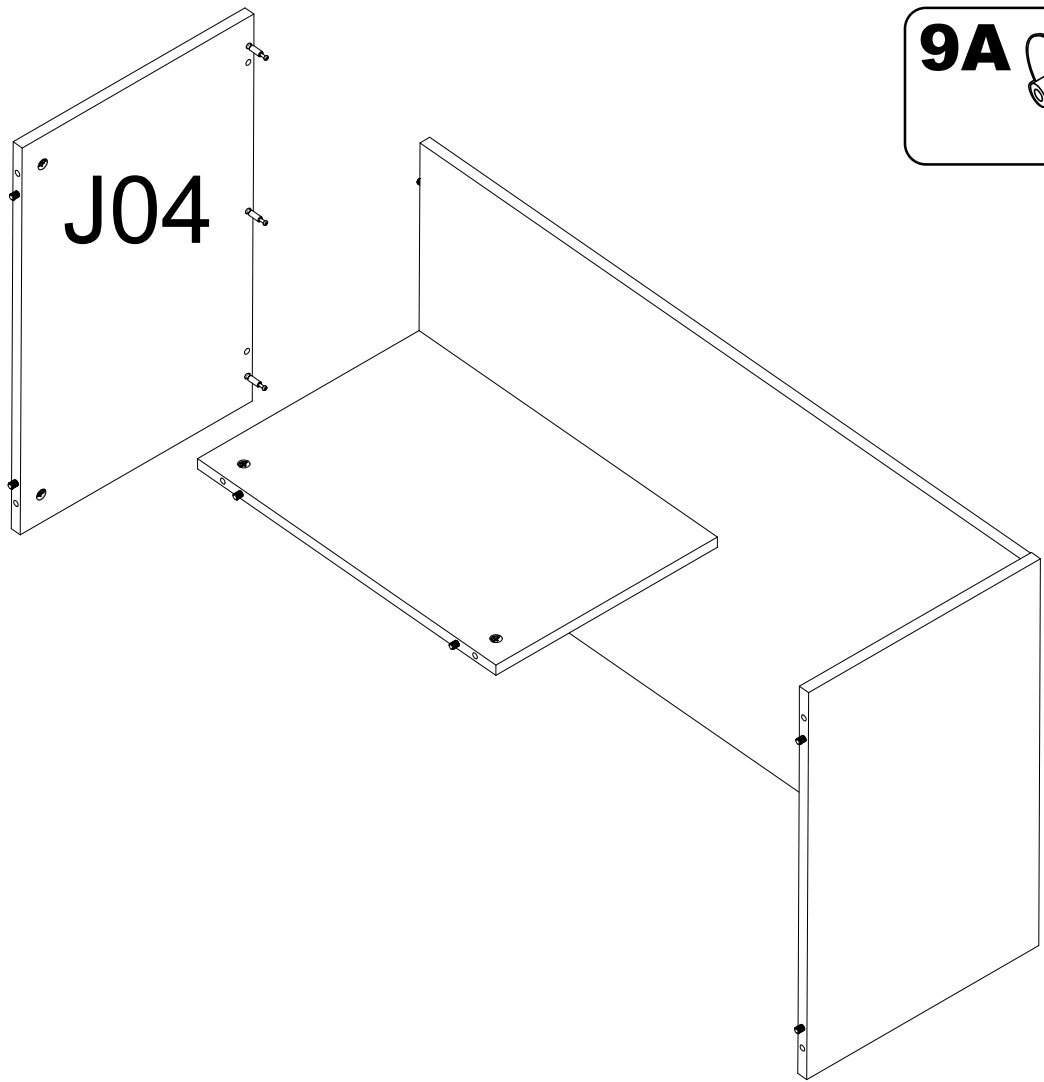

9A x4

8

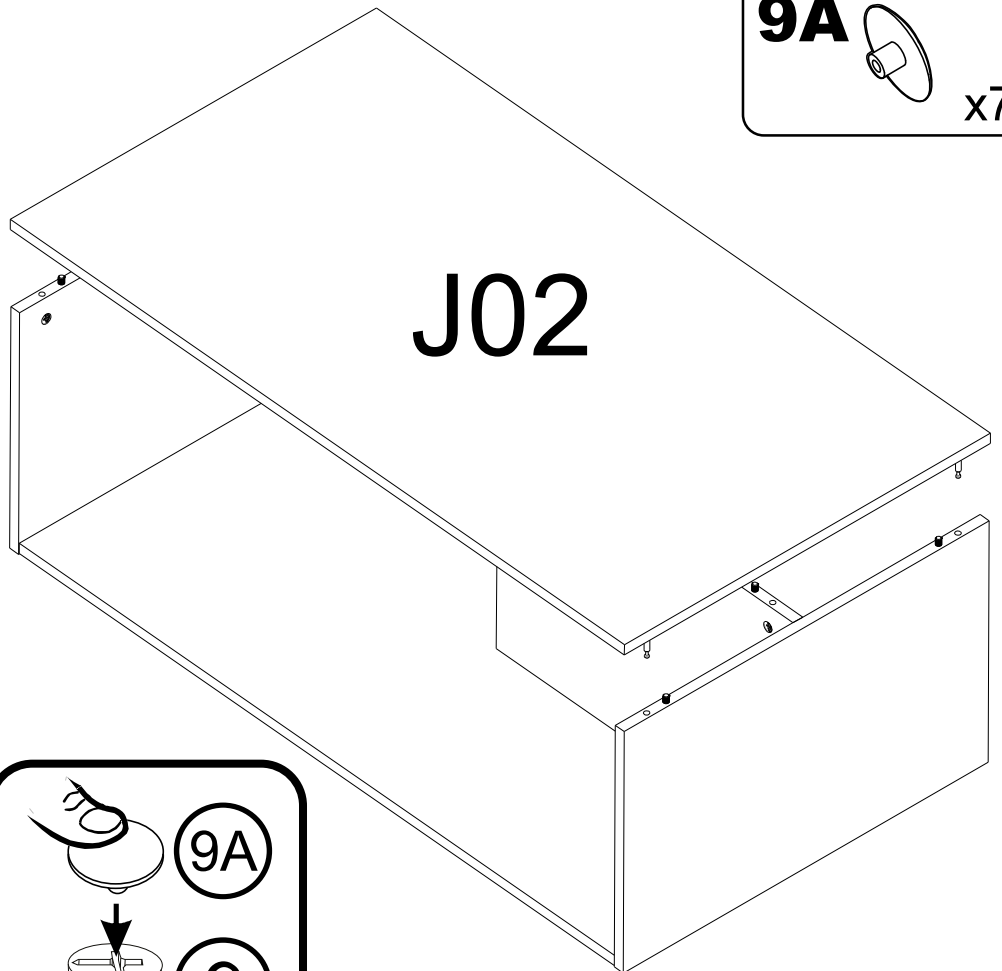

9A x7

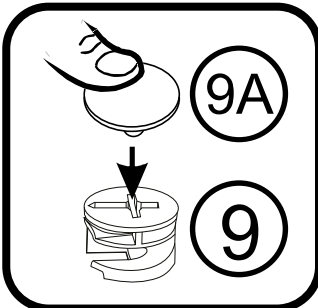
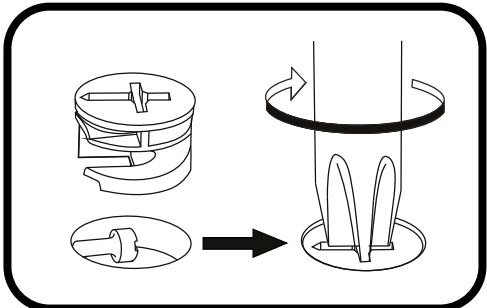

9

