

120 min

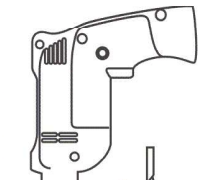

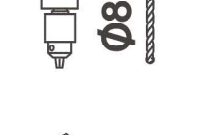

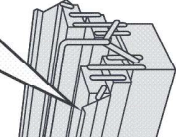
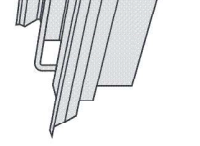
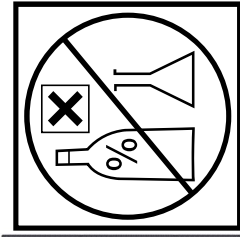
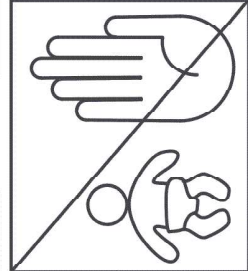
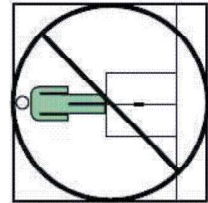
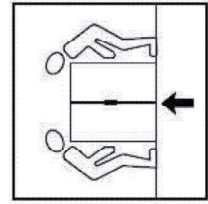
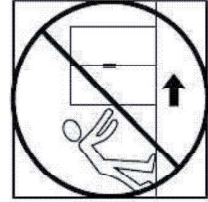
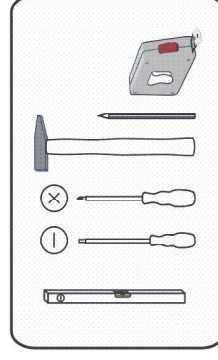
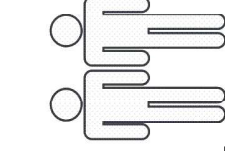
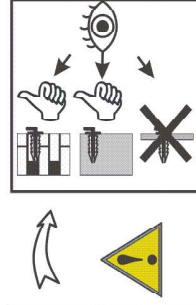
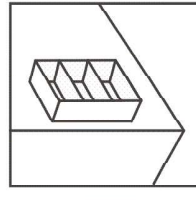
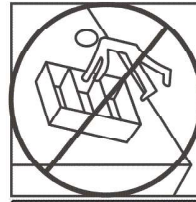
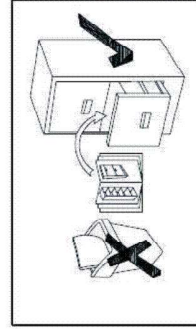
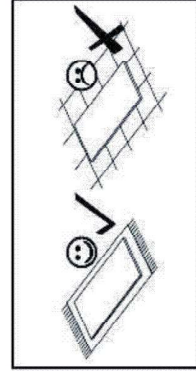
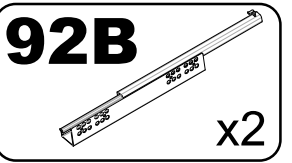
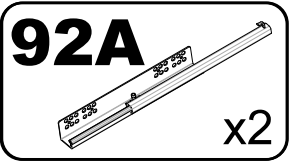
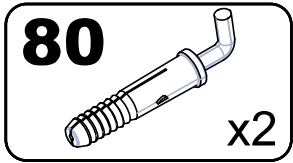
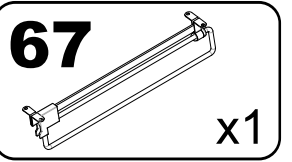
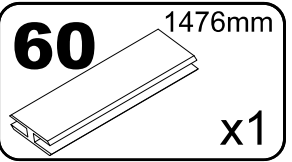
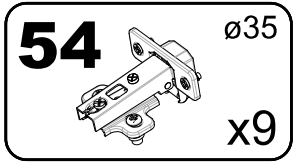
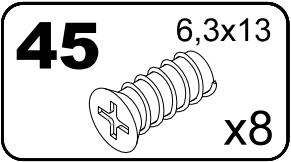
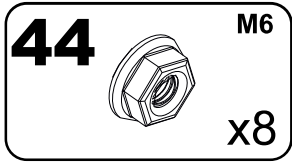
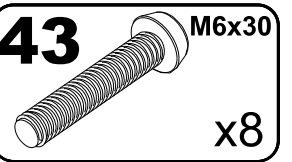
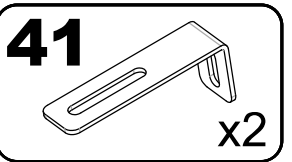
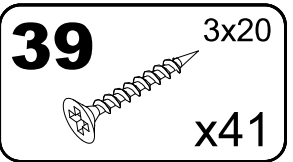
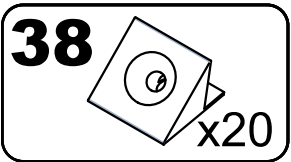
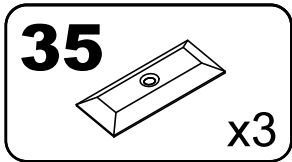
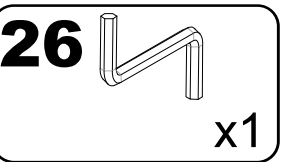
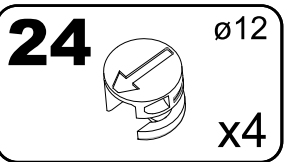
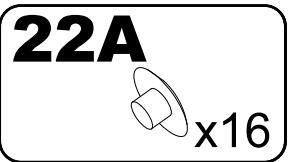
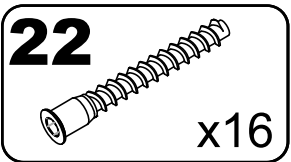
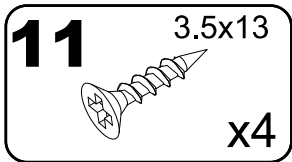
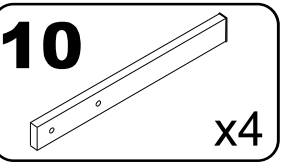
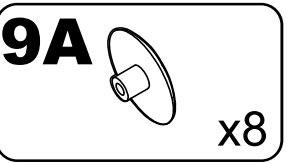
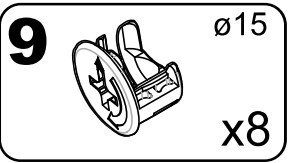
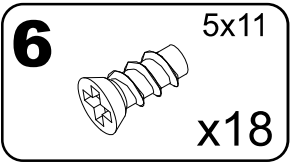
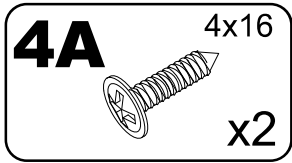
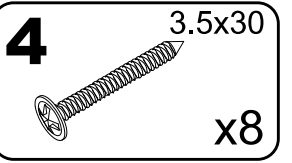
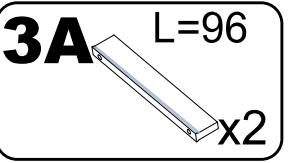
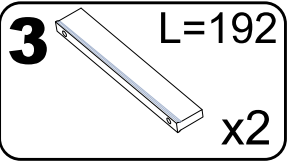
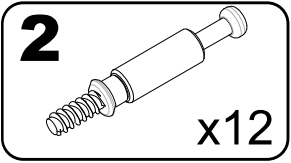
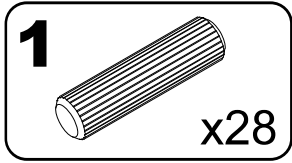
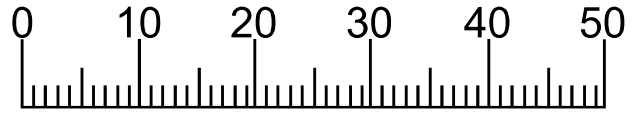
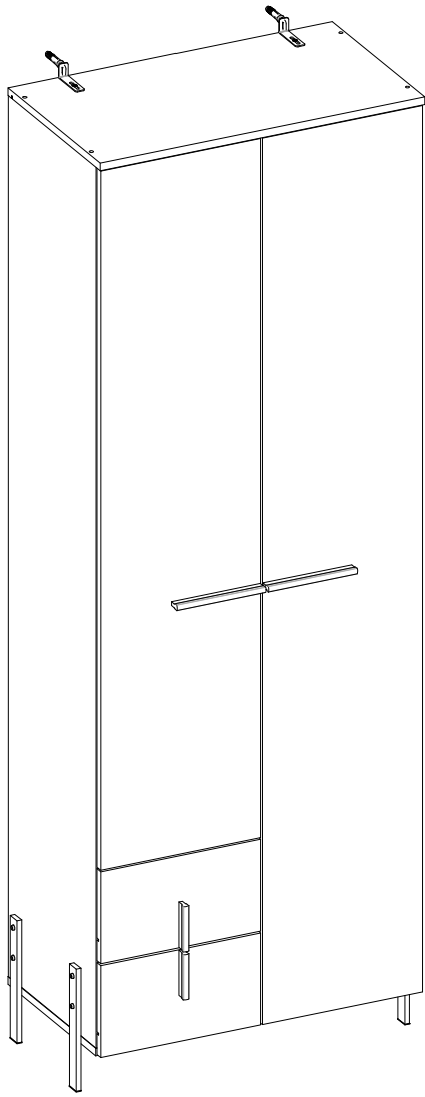
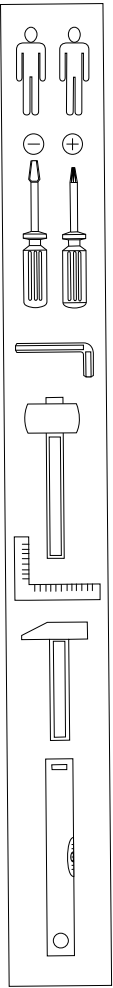
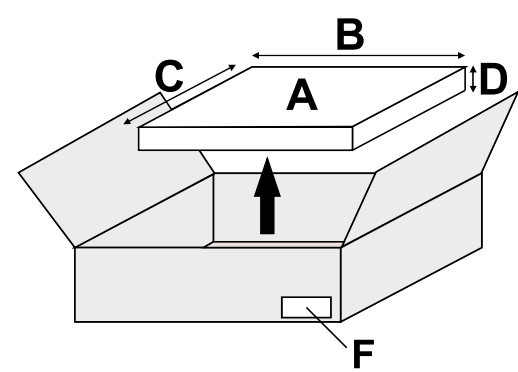
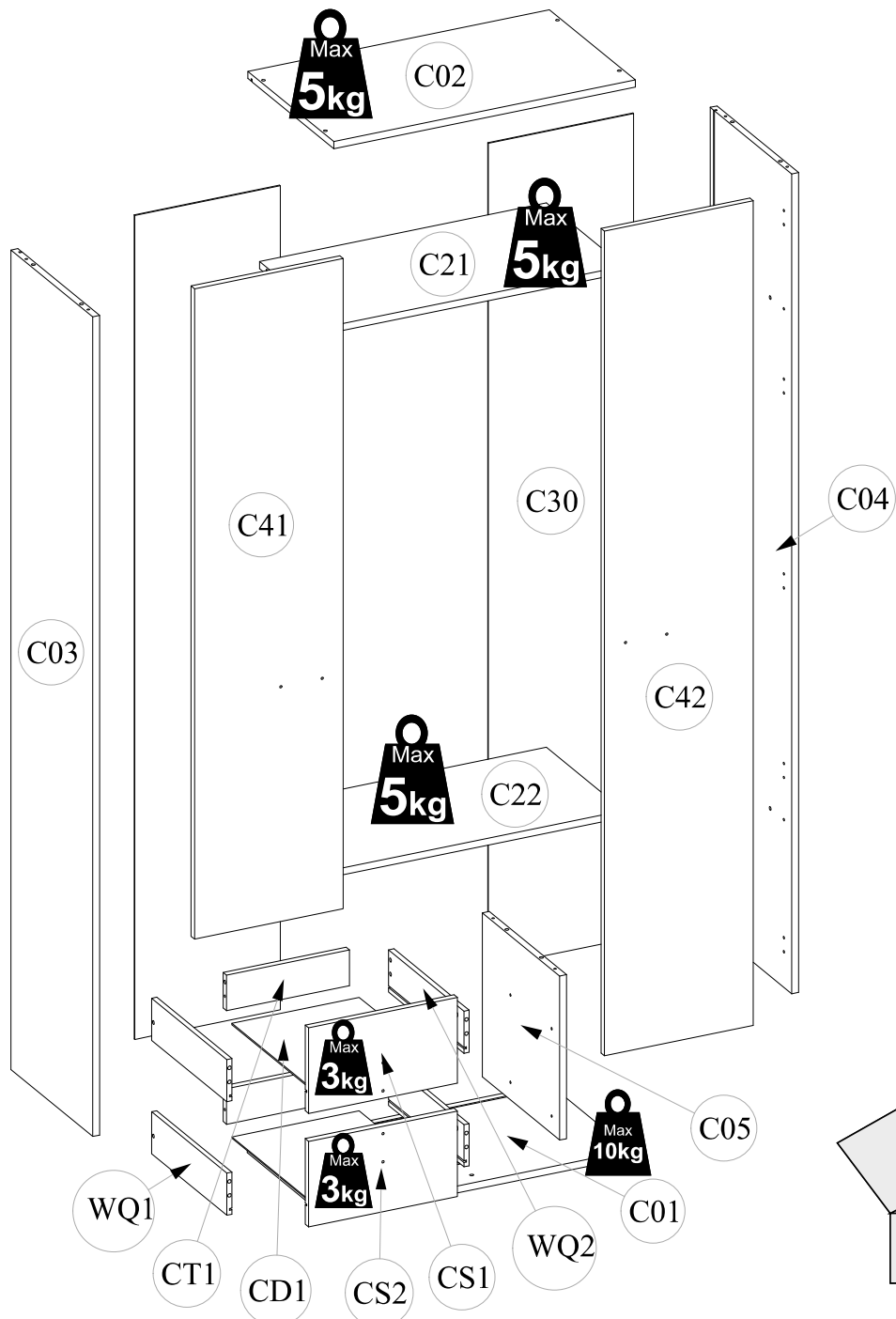

A	B (mm)	C (mm)	D (mm)	E	F
C01	702	380	16	1	1 2
C02	702	400	16	1	1 2
C03	1868	380	16	1	2 2
C04	1868	380	16	1	2 2
C05	374	360	16	1	1 2
C21	668	360	16	1	1 2
C22	668	360	16	1	1 2
C30	1878	338	3	2	2 2
C41	1482	346	16	1	2 2
C42	1879	346	16	1	2 2
CD1	296	353	3	2	1 2
CS1	346	195	16	1	2 2
CS2	346	195	16	1	2 2
CT1	286	81	16	2	1 2
WQ1	350	96	12	2	1 2
WQ2	350	96	12	2	1 2

1

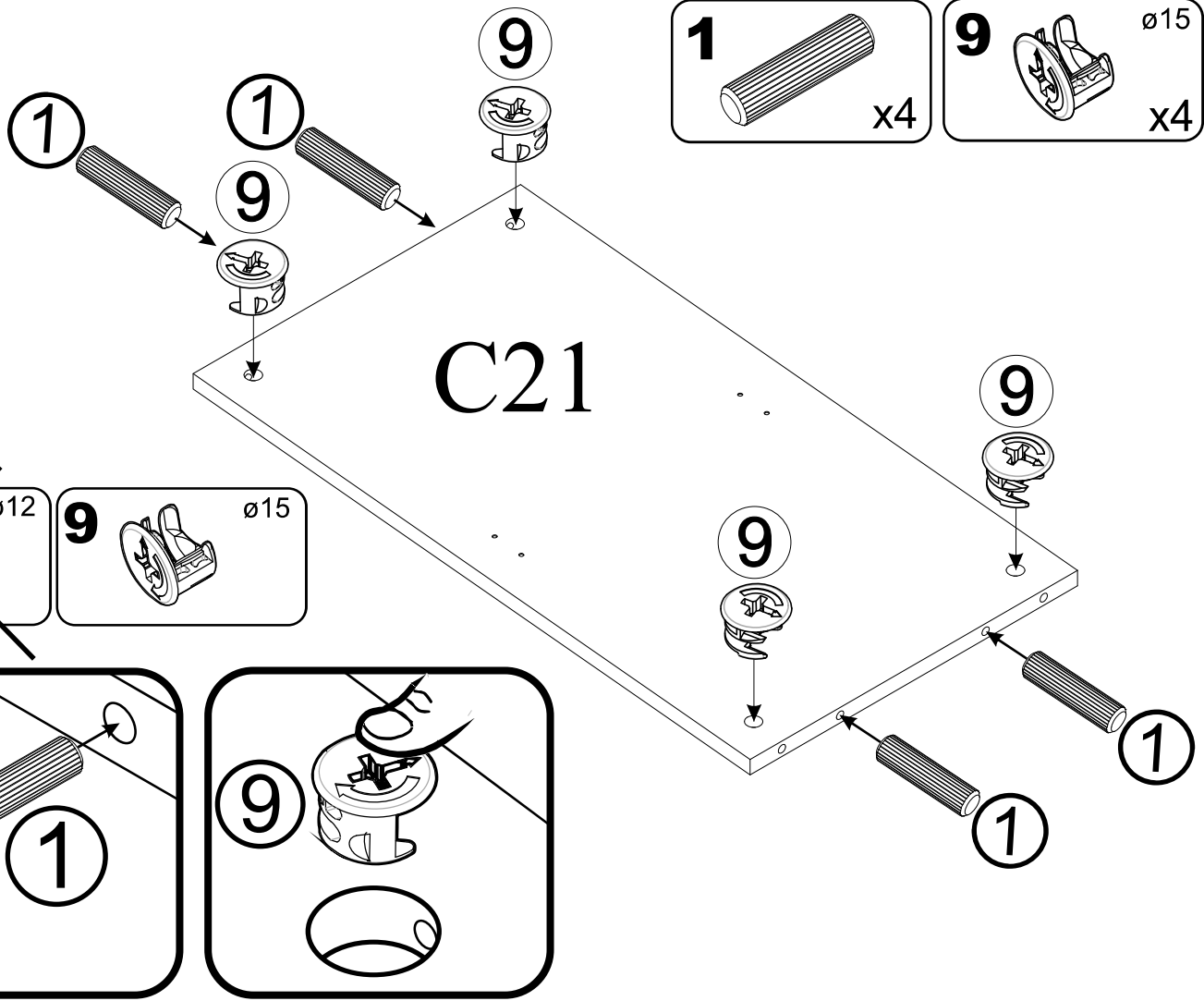

2

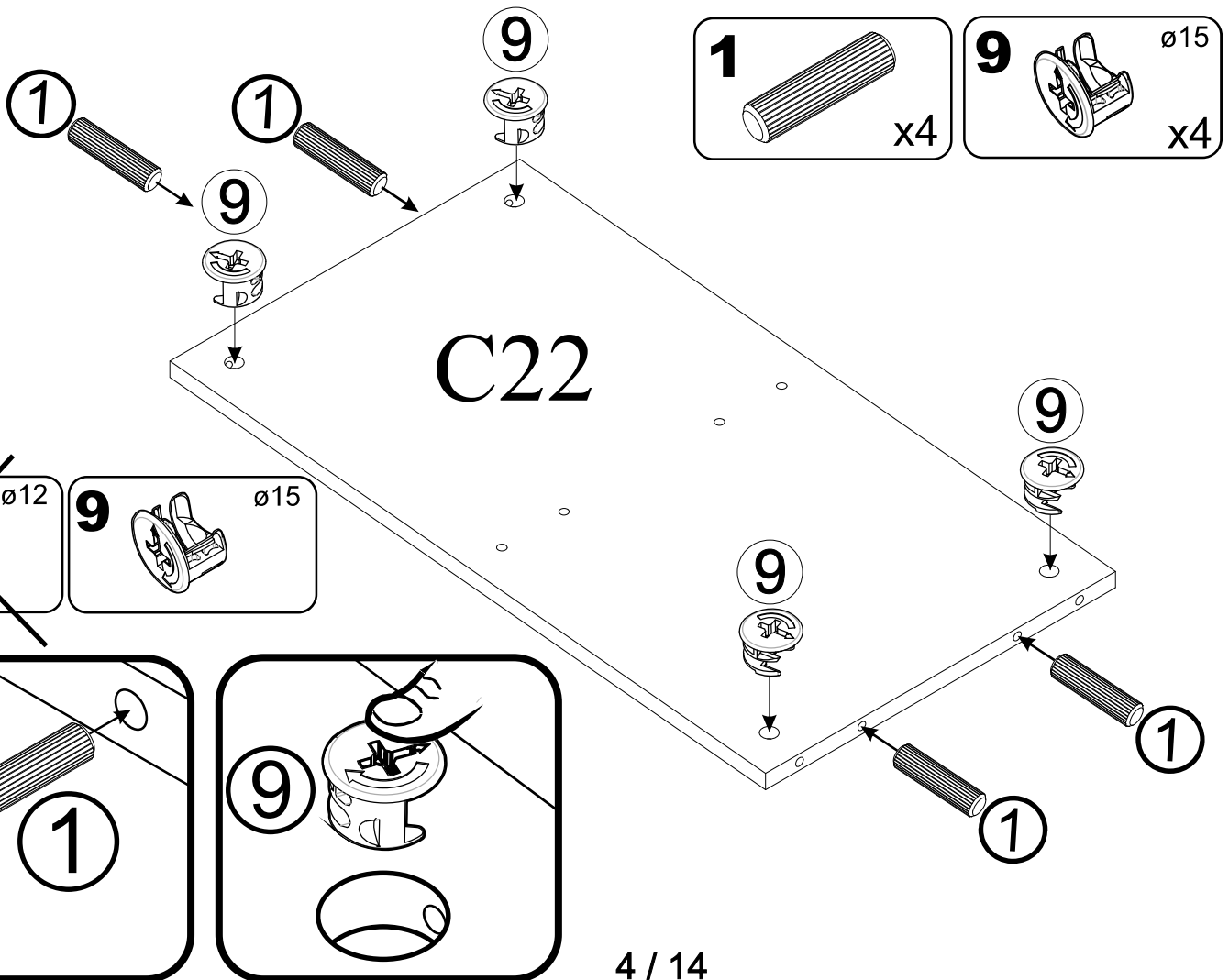

3

- 1** x4
- 45** 6,3x13 x4
- 92B** x2

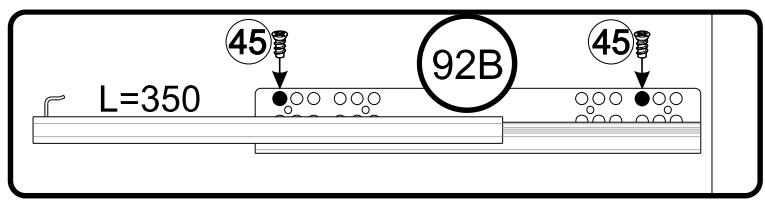
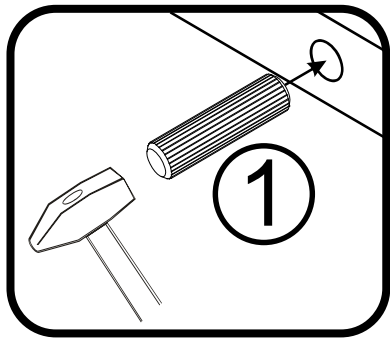
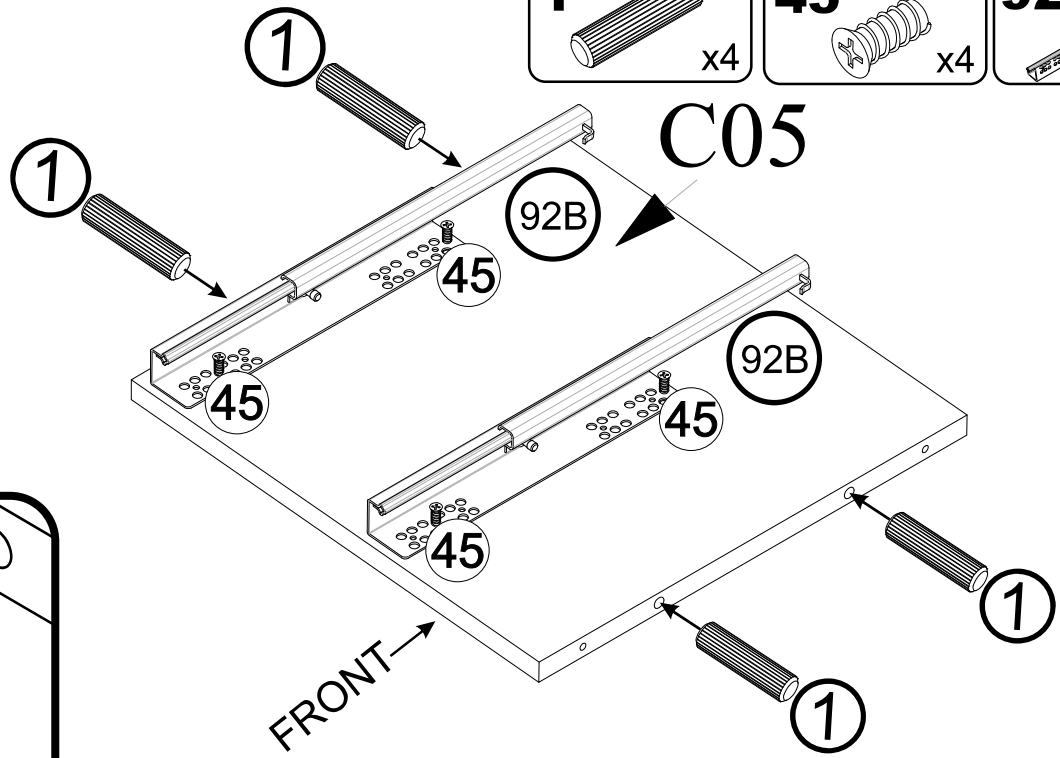

4

- 1** x4
- 2** x4
- 45** 6,3x13 x4
- 54** $\varnothing 35$ x4
- 92A** x2

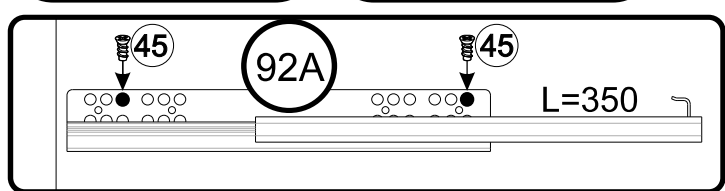
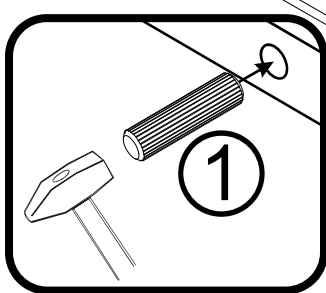
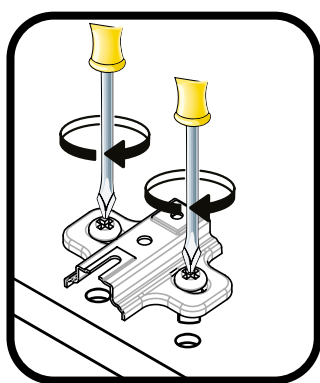
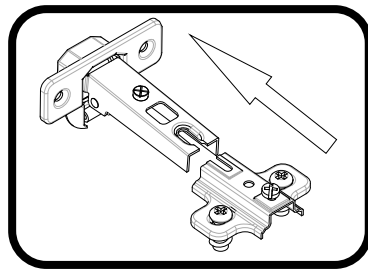
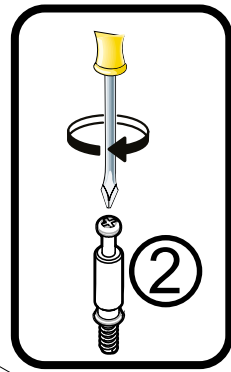
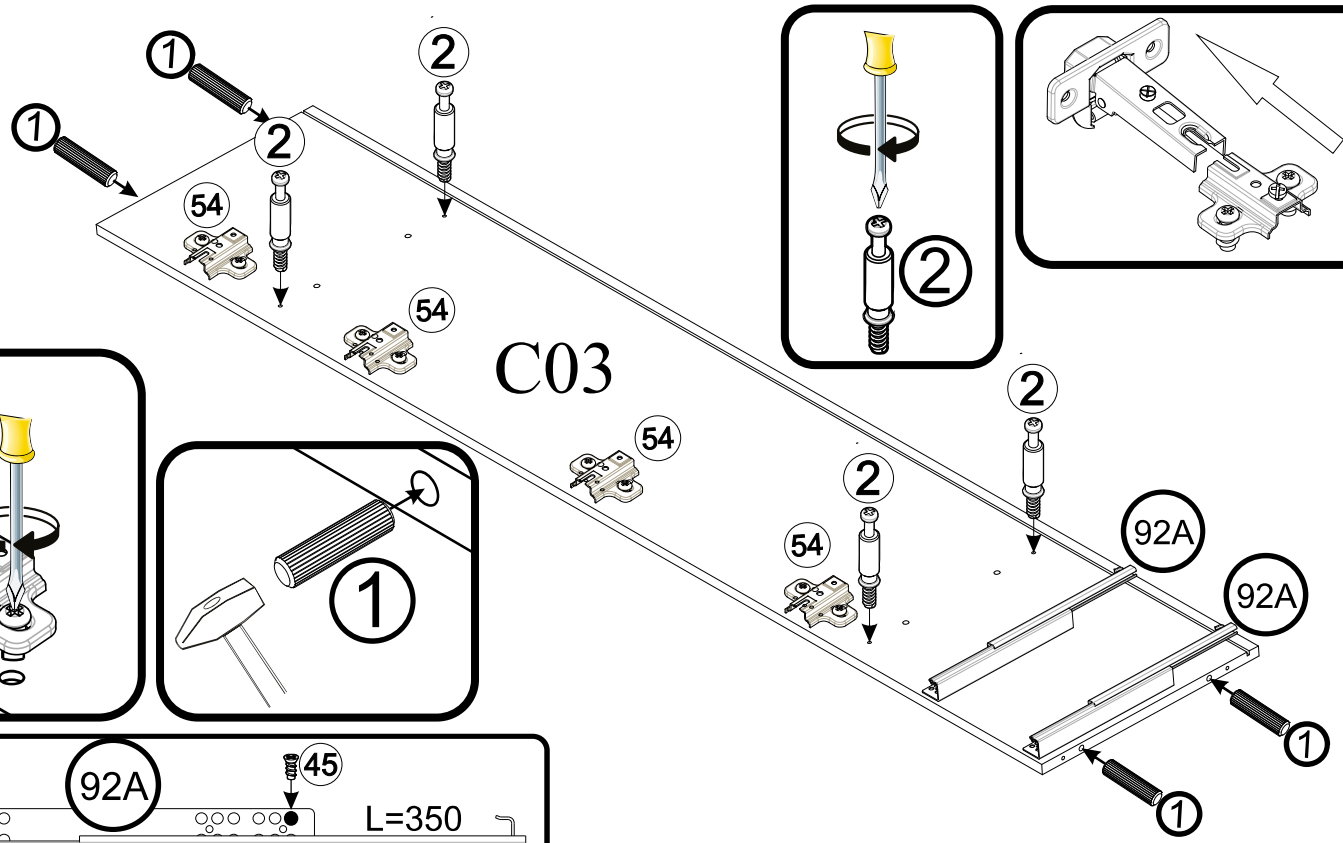

5

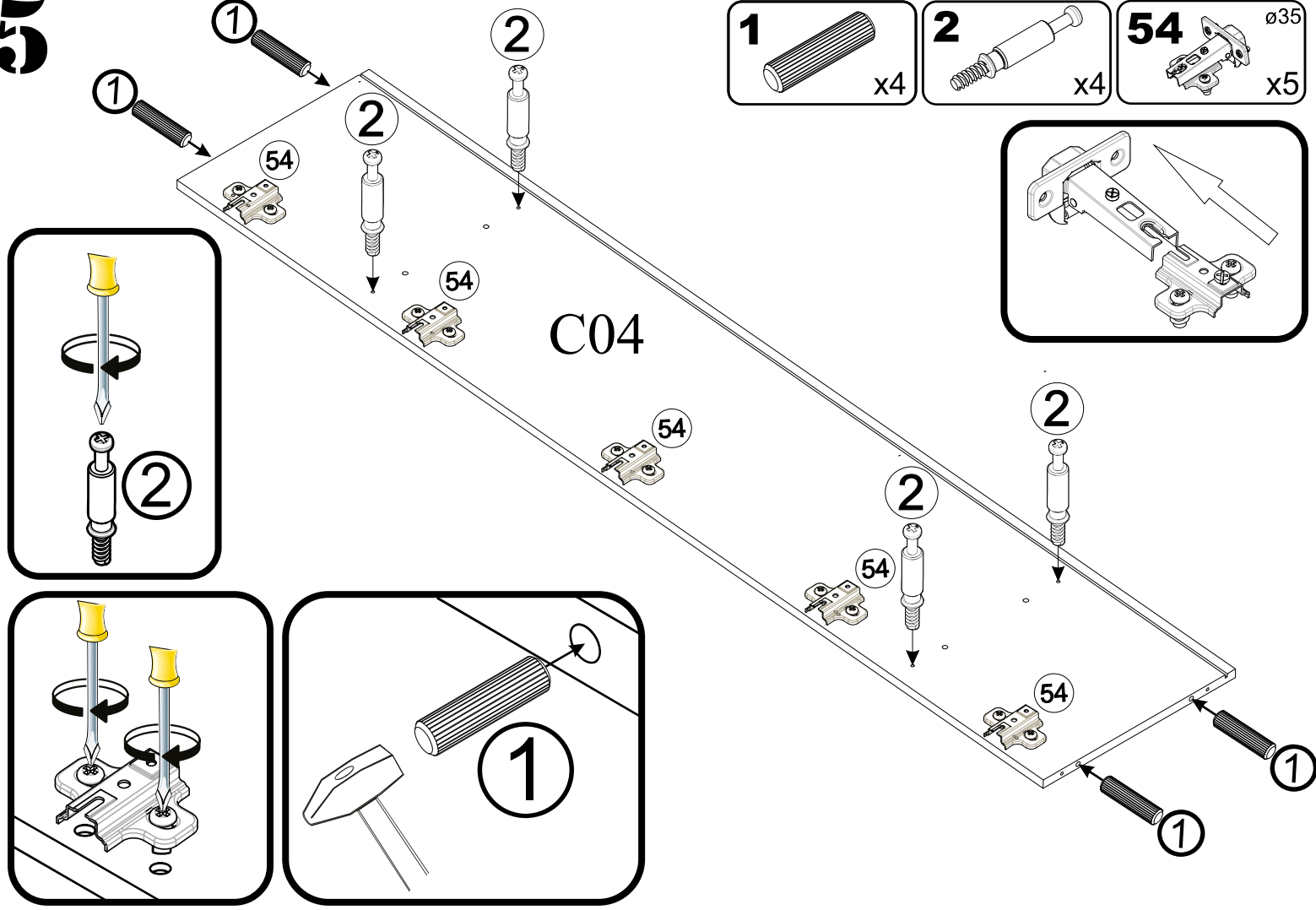

6

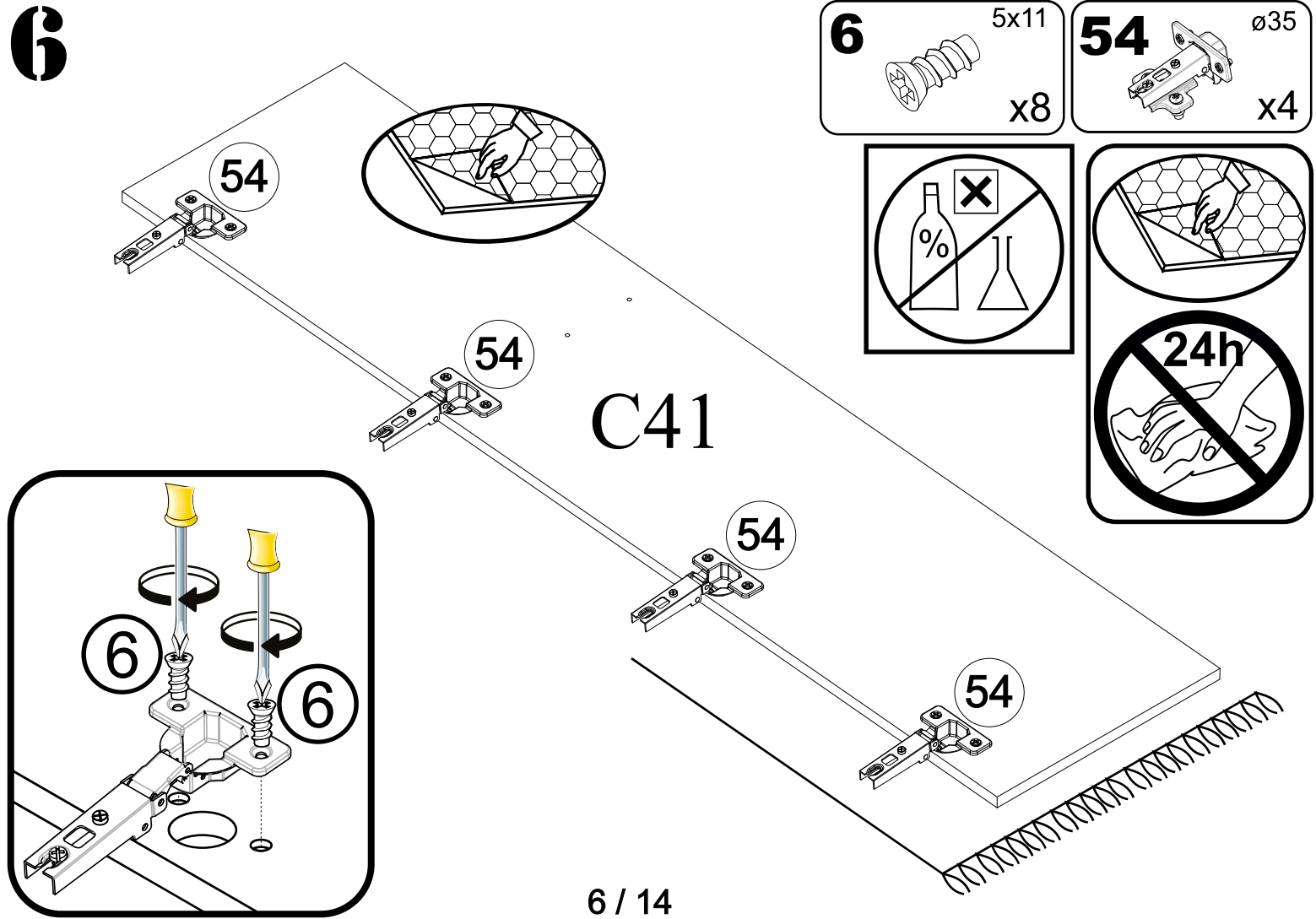

8

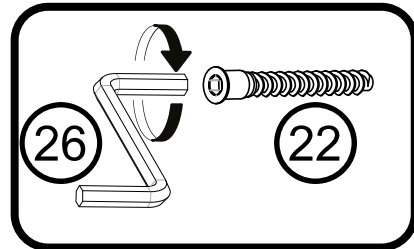
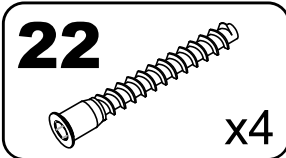
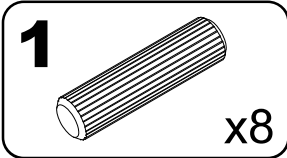

x2

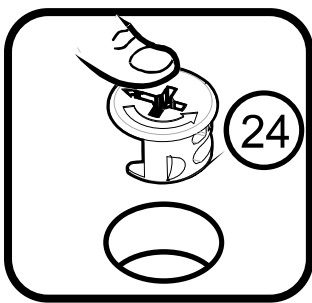
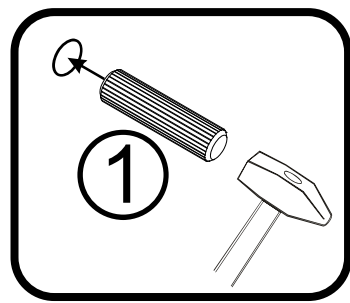
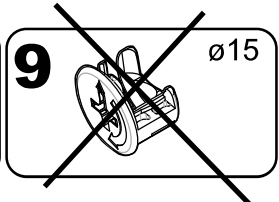
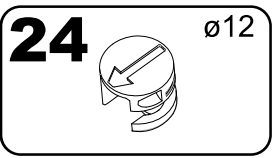
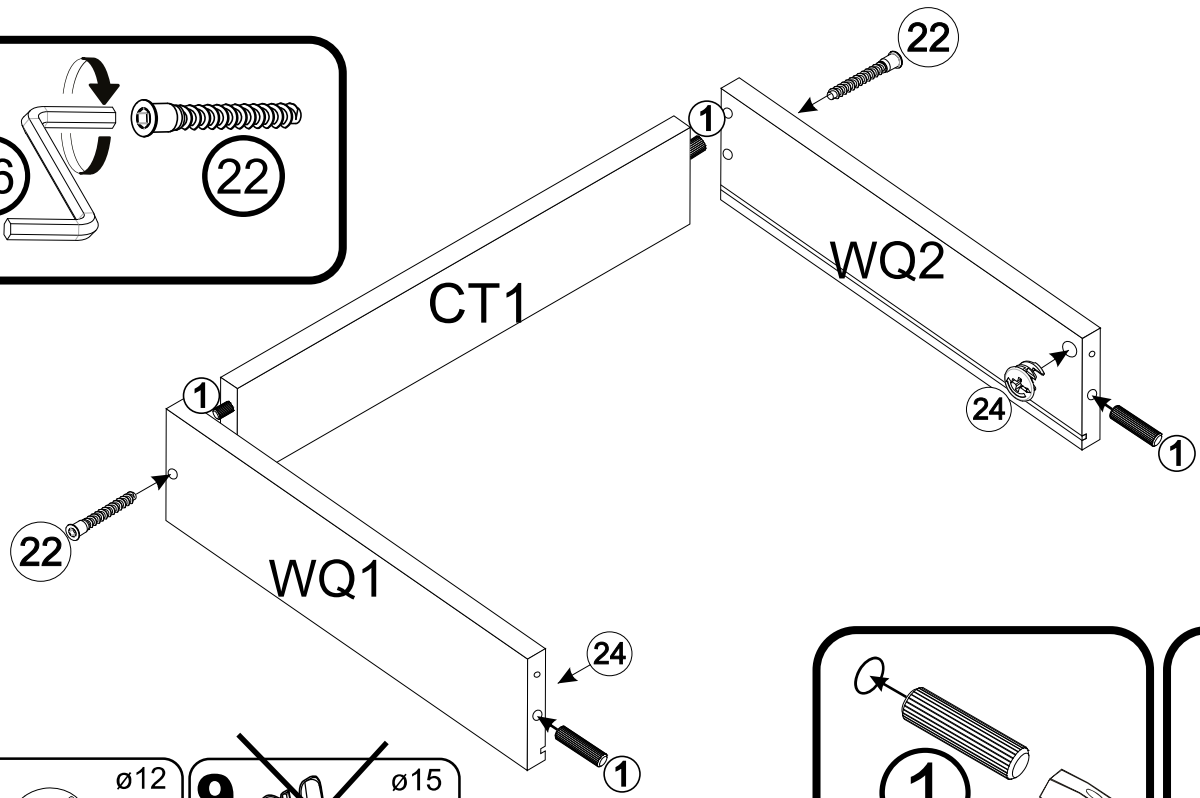

9

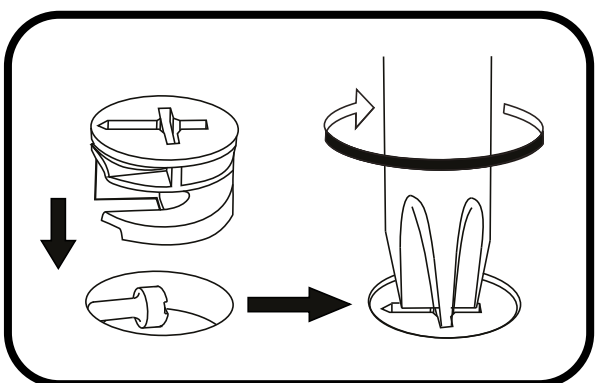
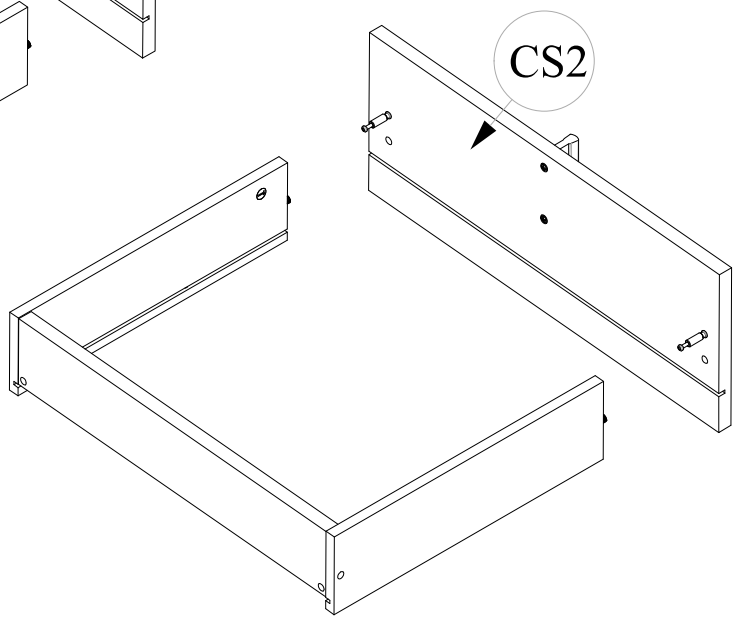
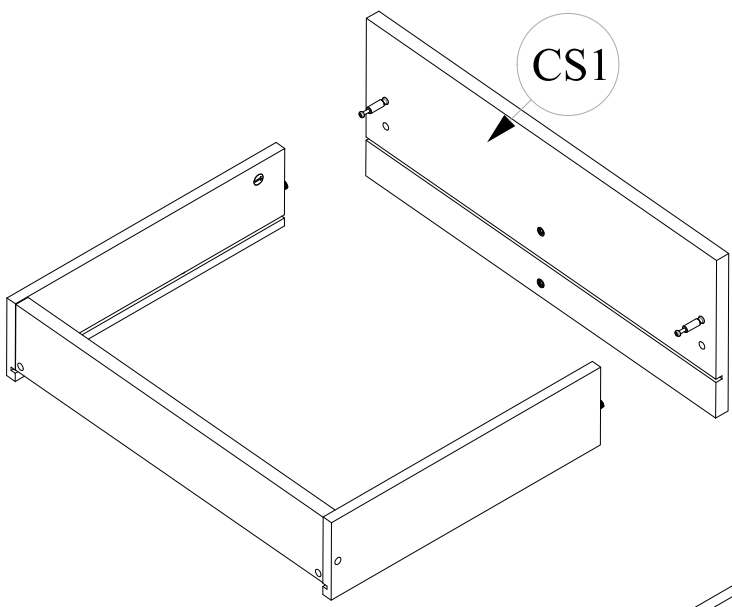

10

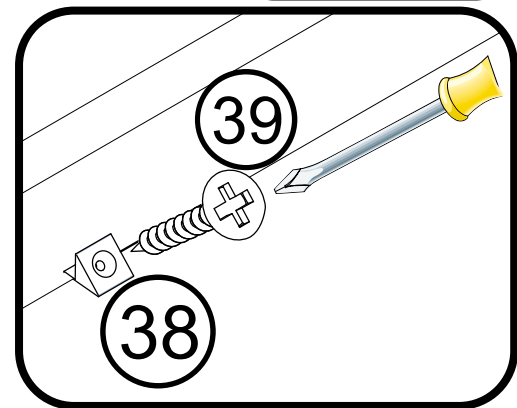
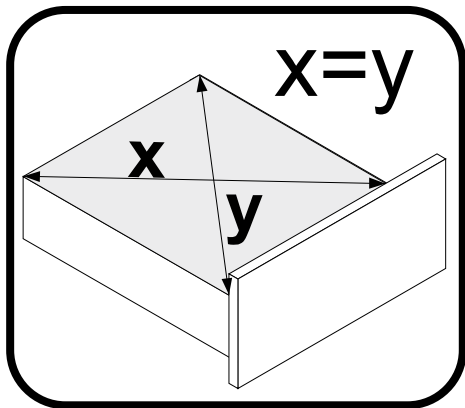
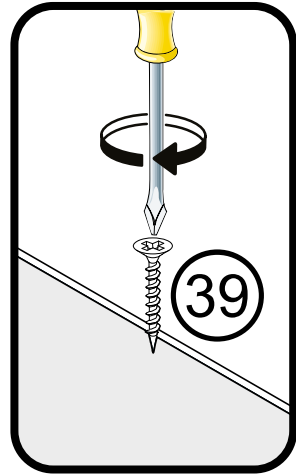
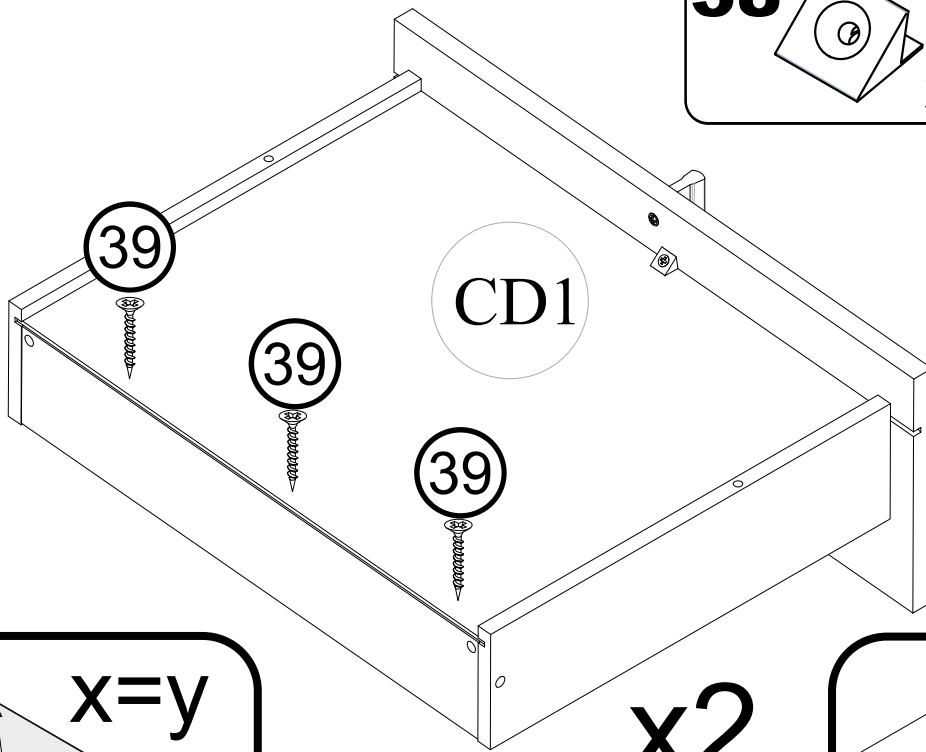
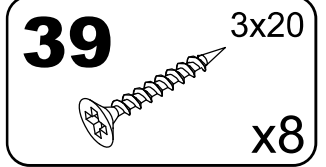
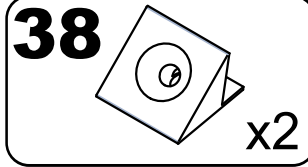

11

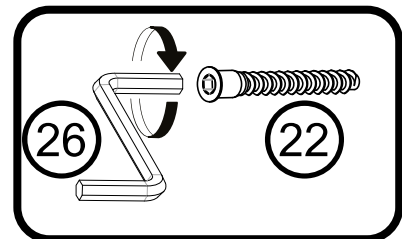
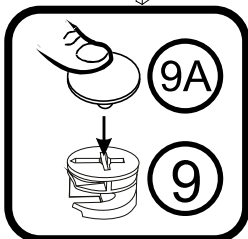
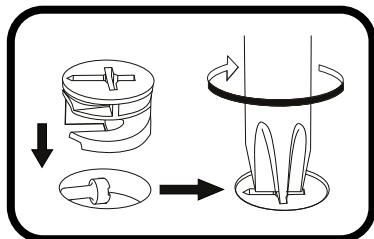
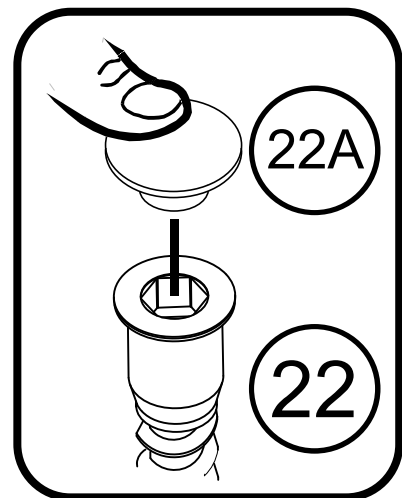
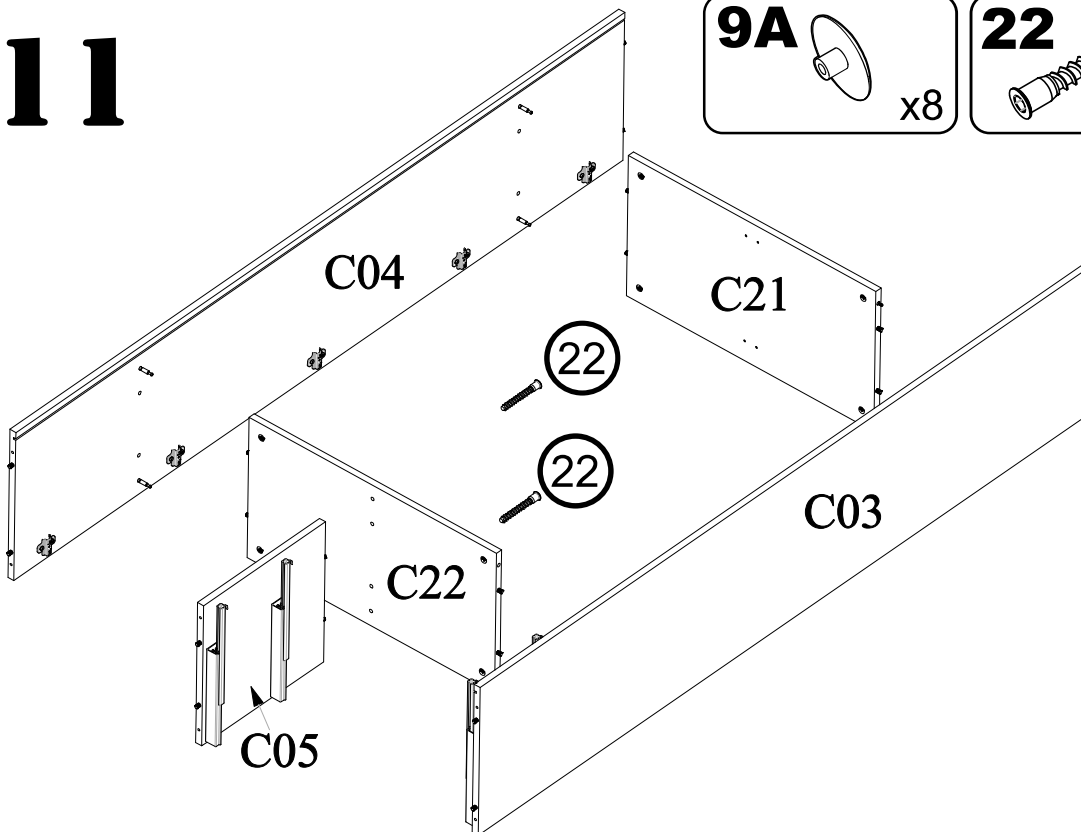
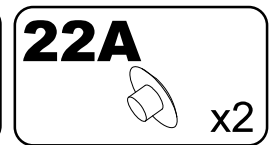
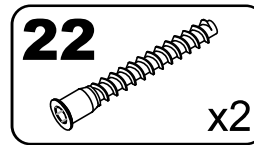
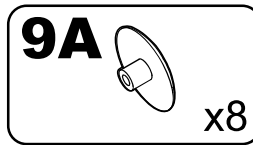

12

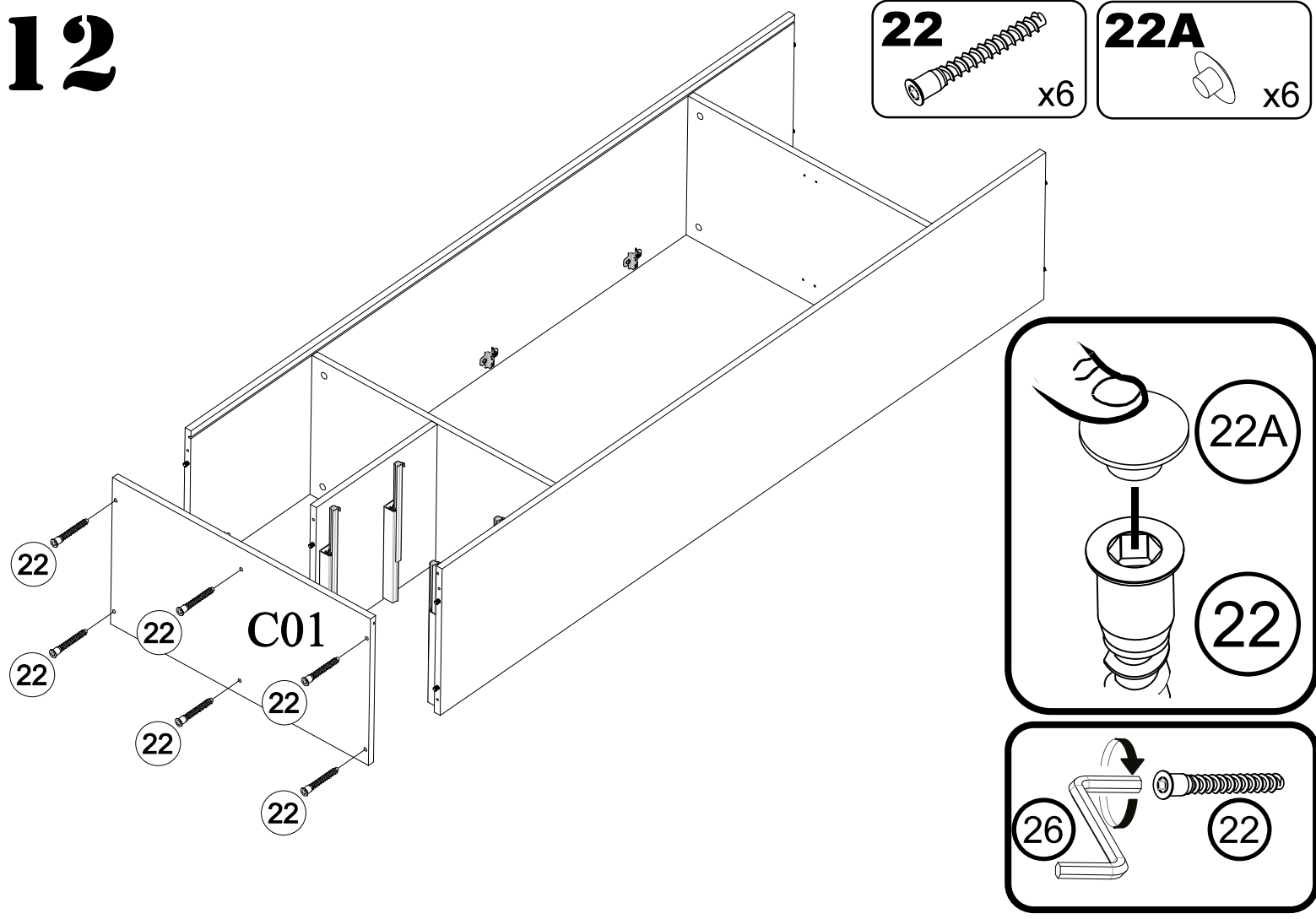

13

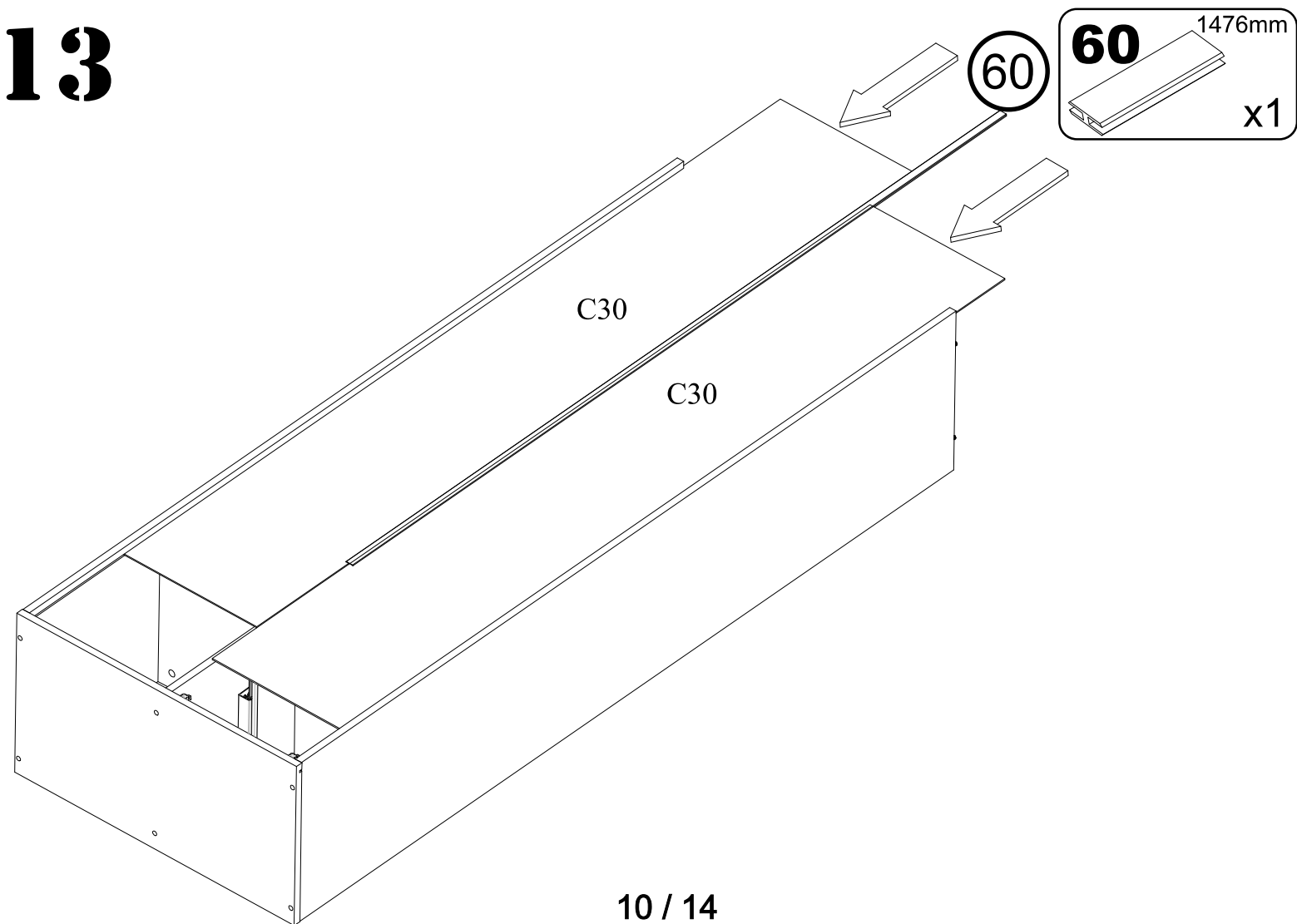

14

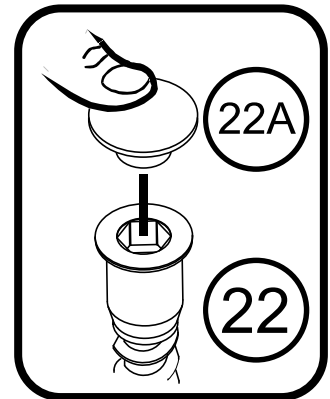
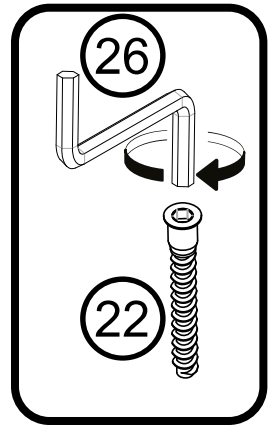
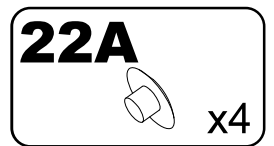
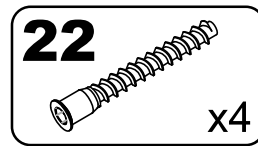
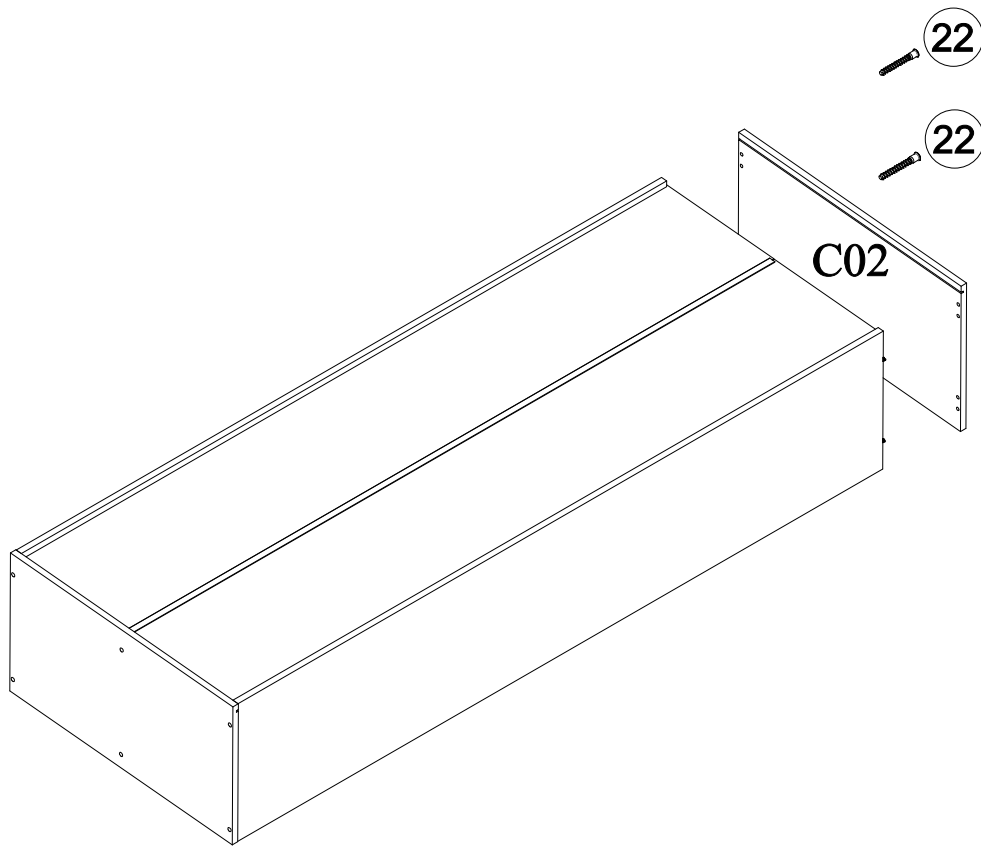

15

A=B

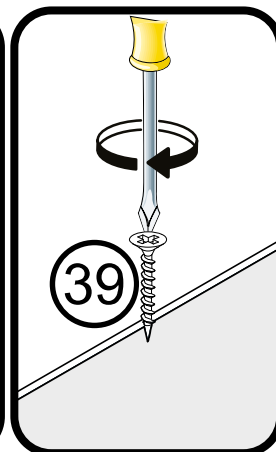
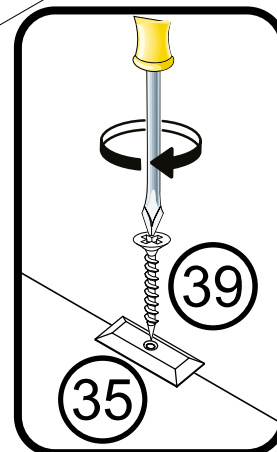
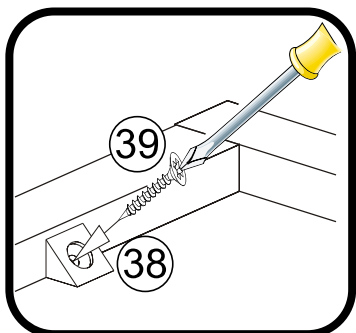
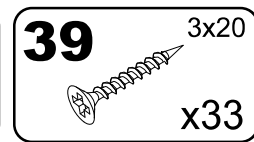
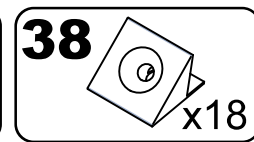
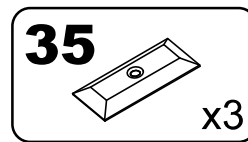
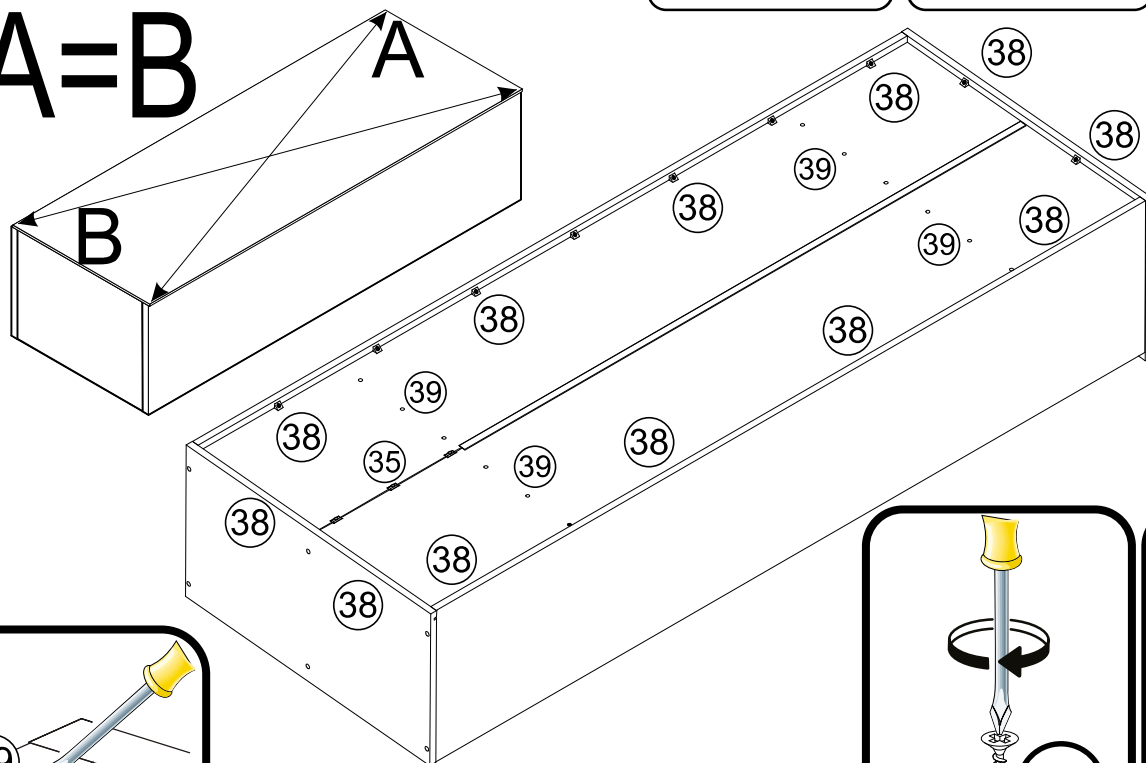

16

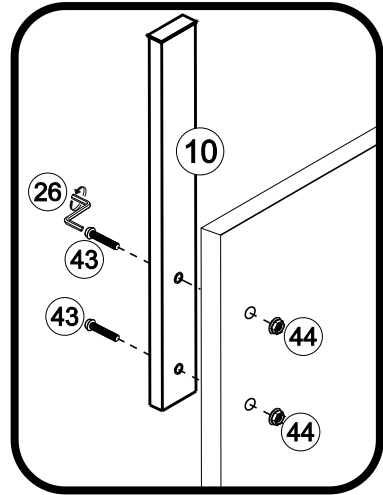
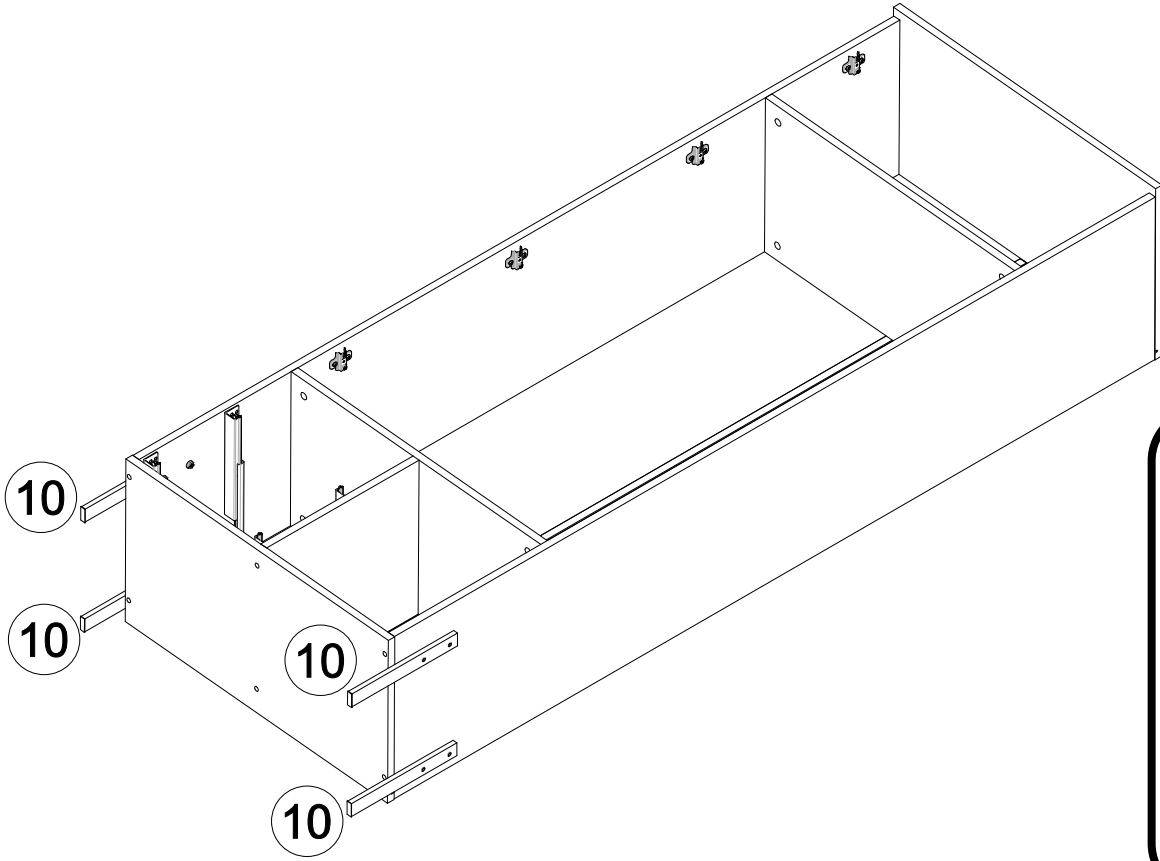
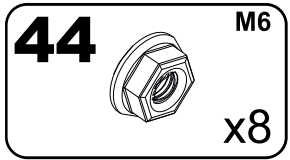
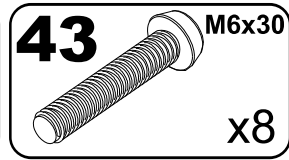
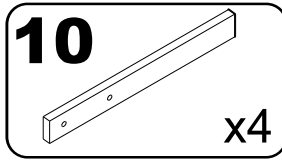

17

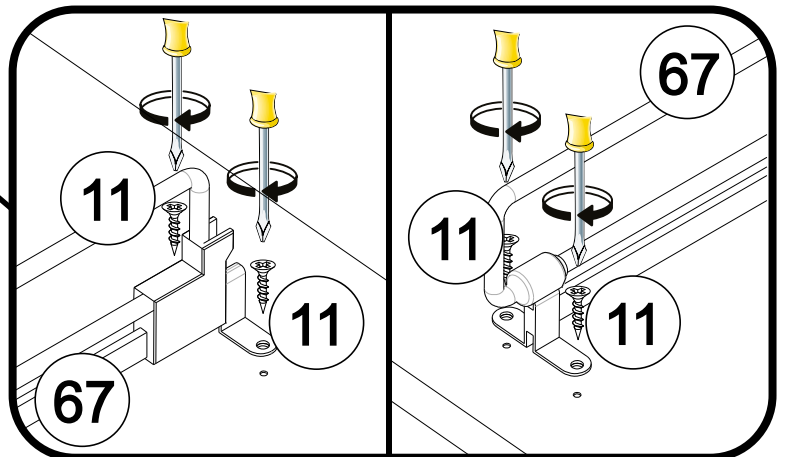
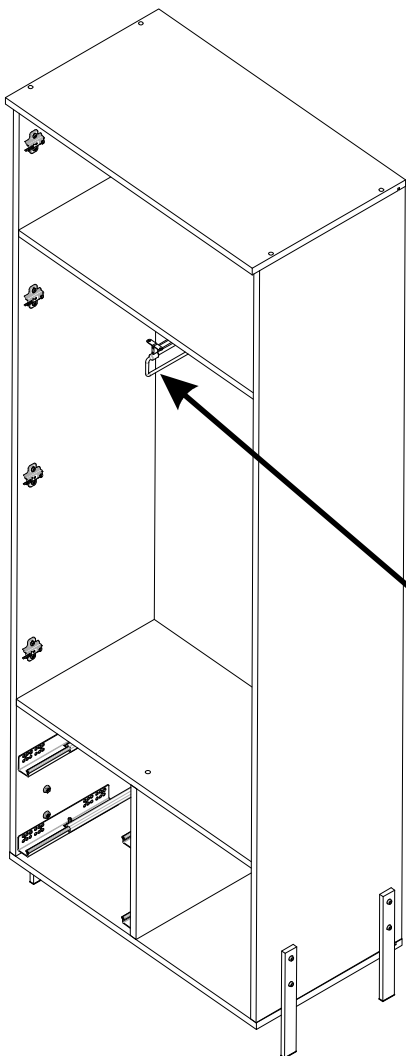
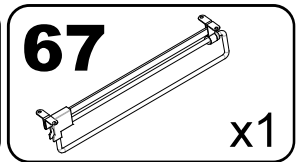
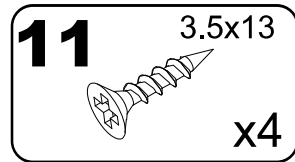

18

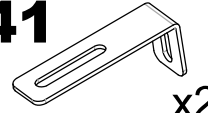
41  x2

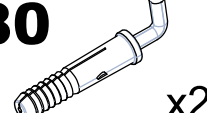
80  x2

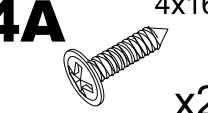
4A  4x16 x2

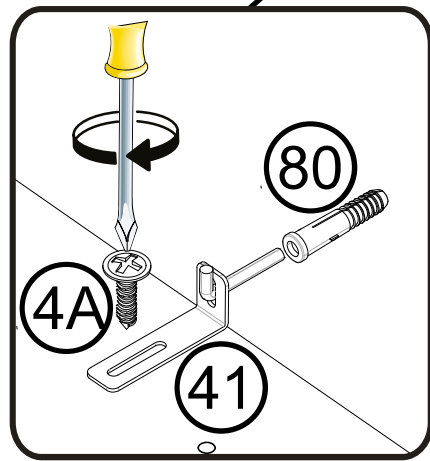
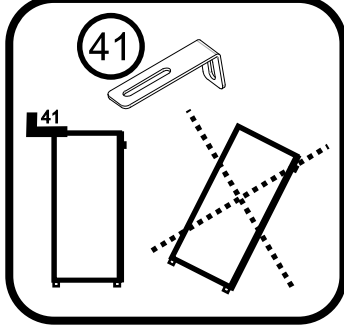
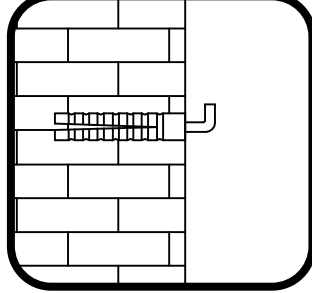
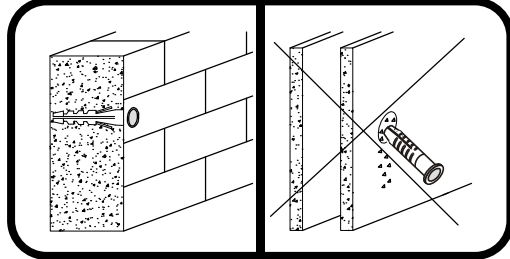
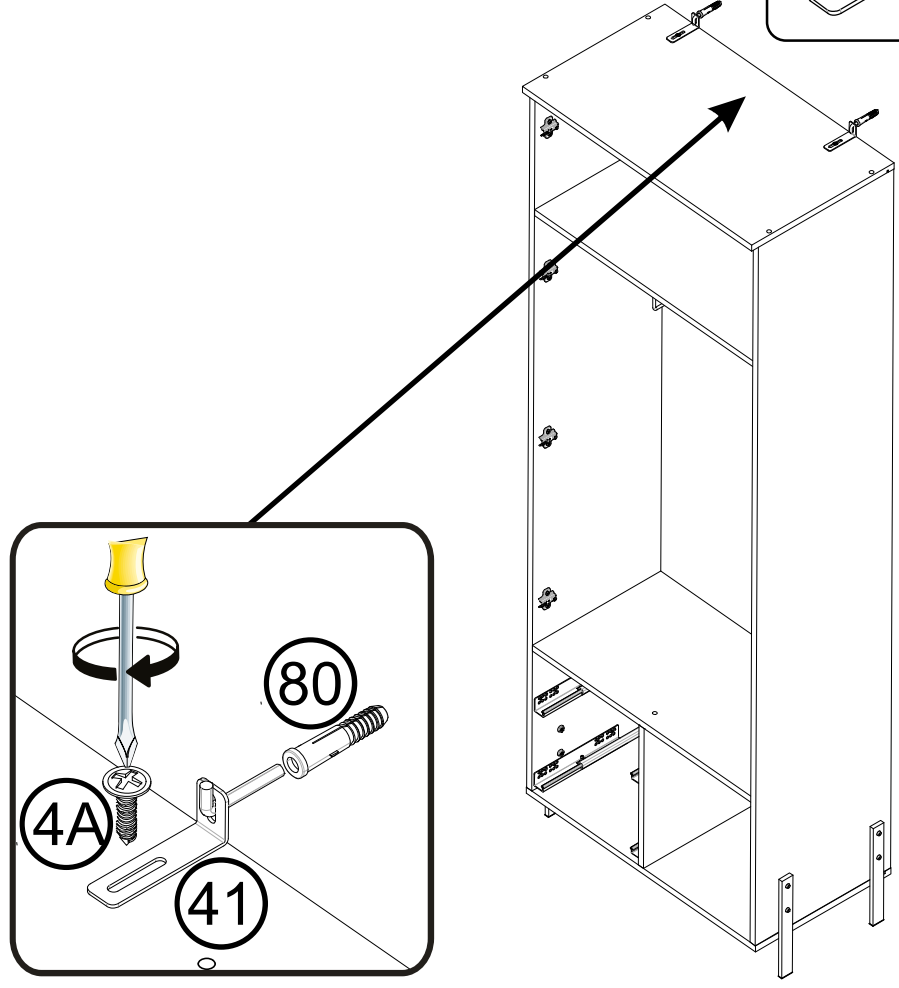

19

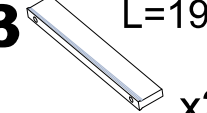
3  L=192 x2

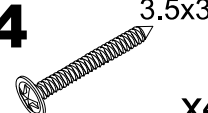
4  3.5x30 x4

