

A

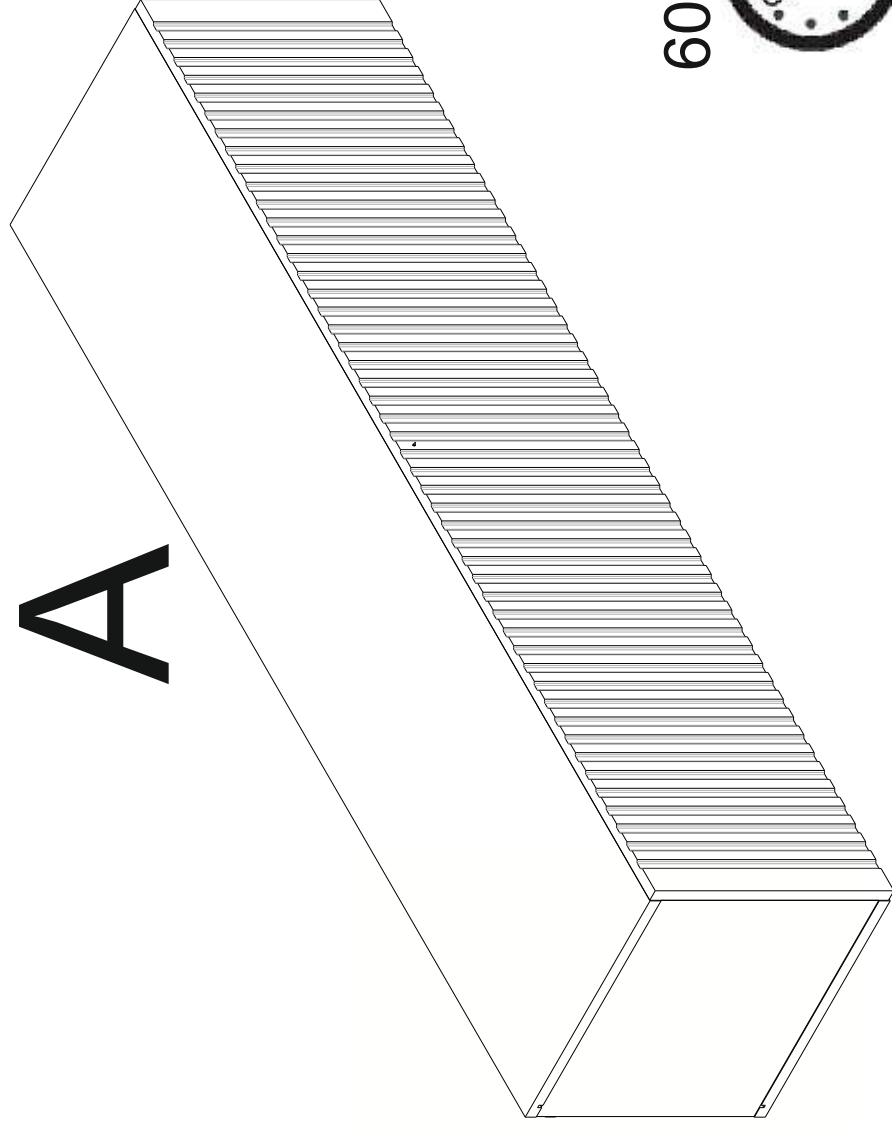

60 min

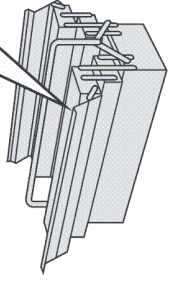

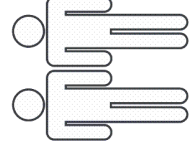
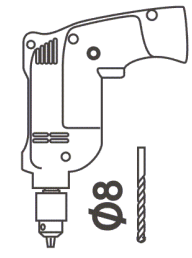
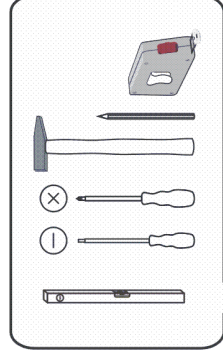
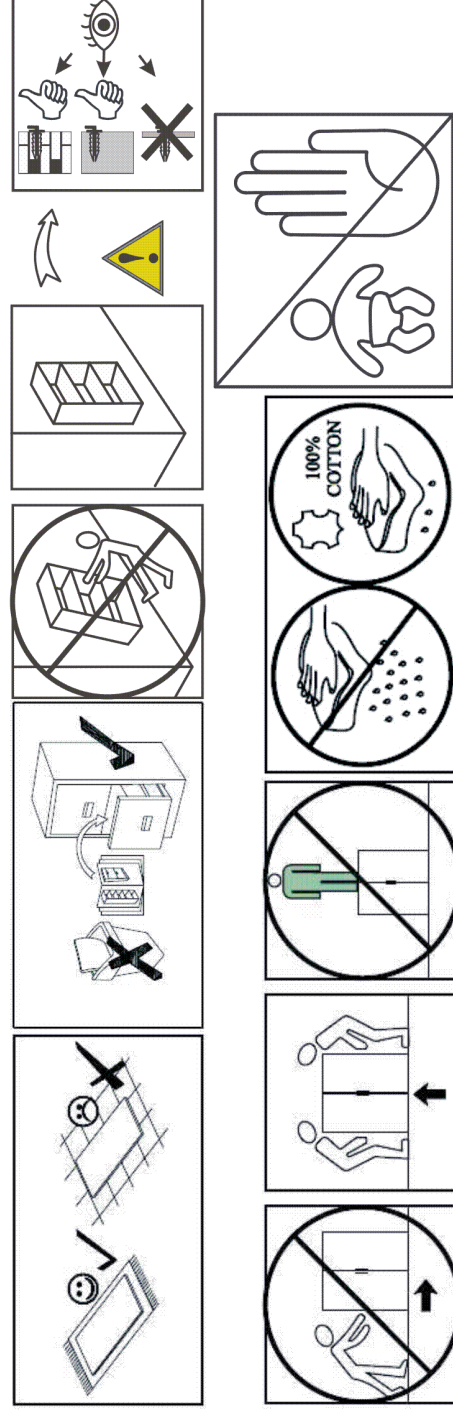
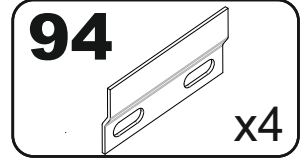
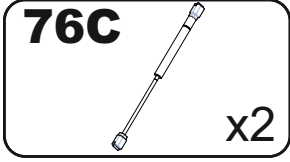
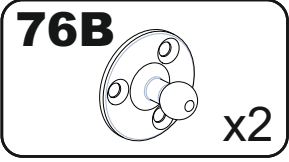
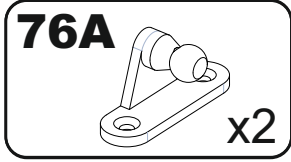
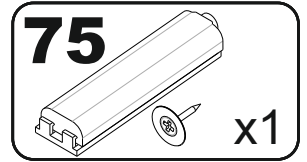
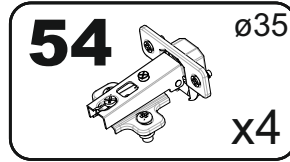
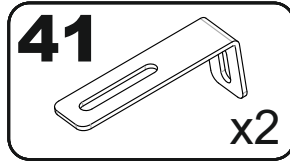
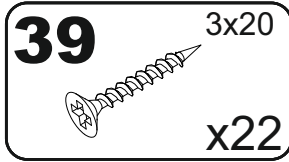
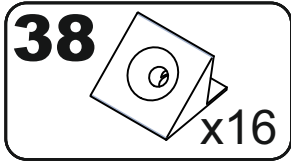
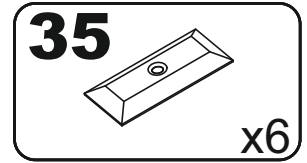
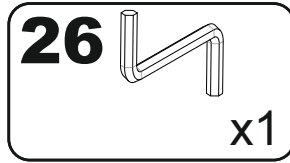
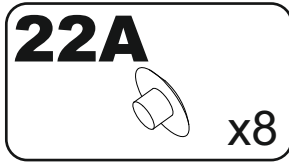
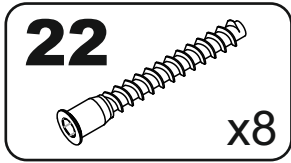
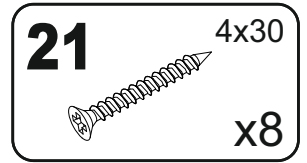
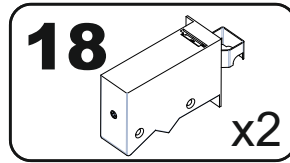
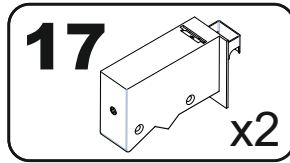
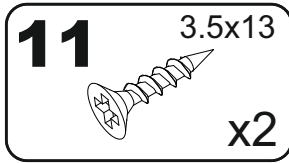
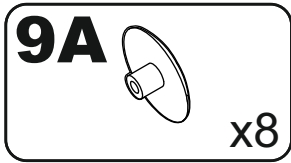
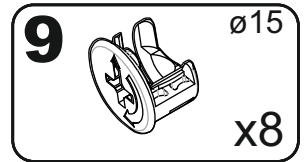
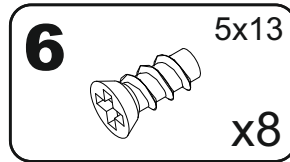
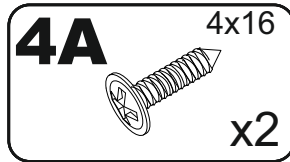
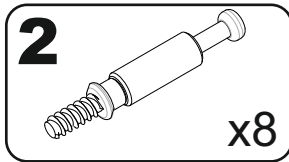
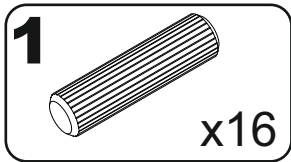
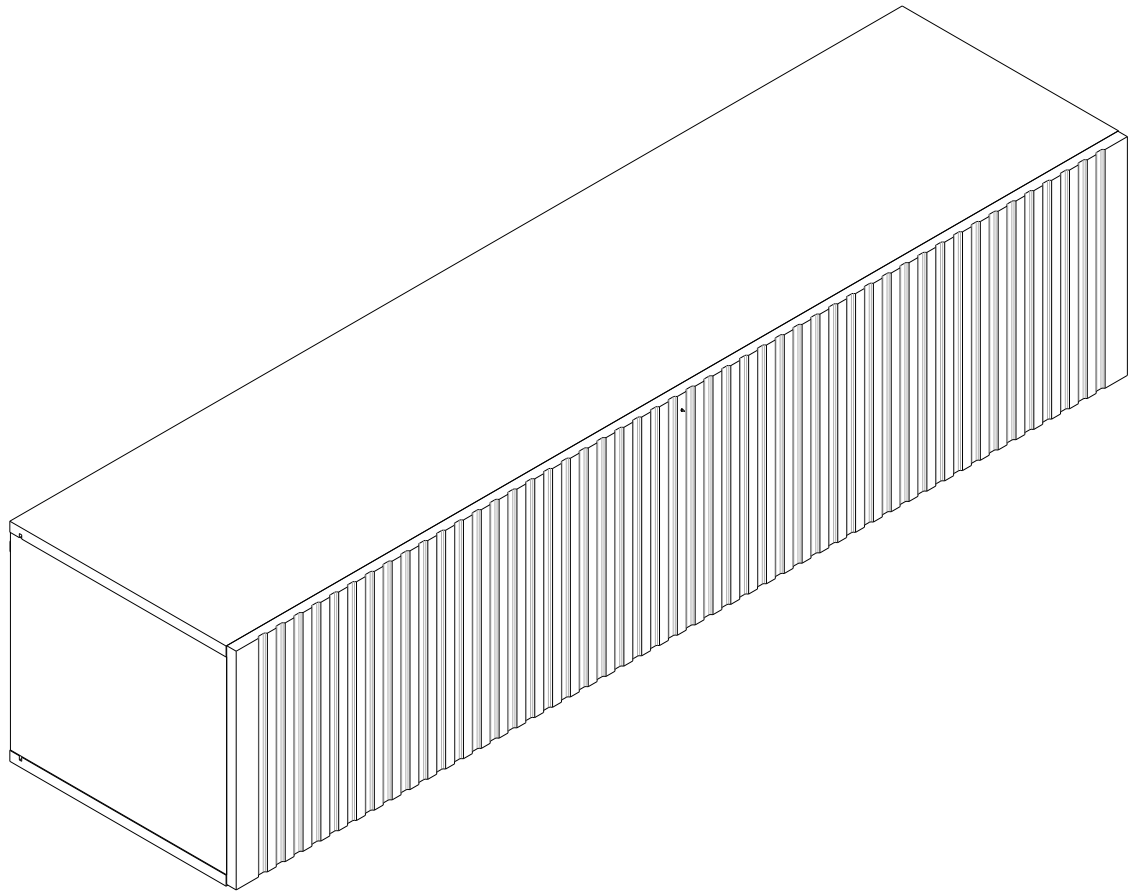
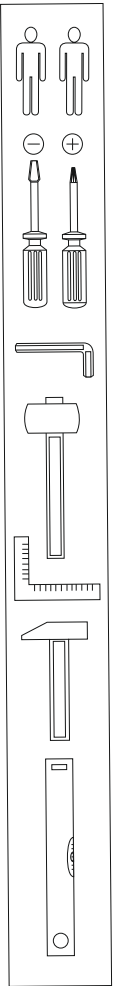

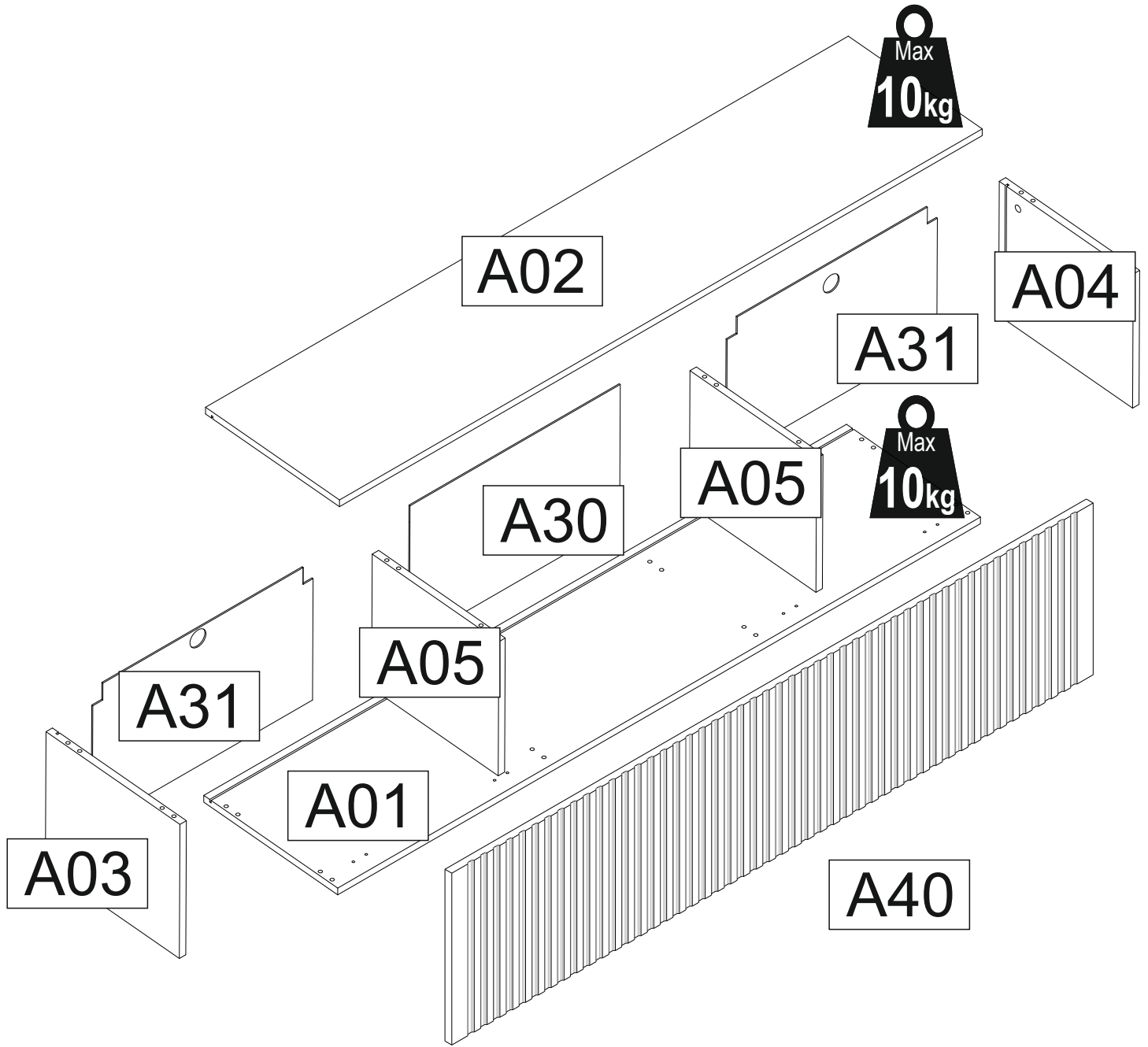

A	B_(mm)	C_(mm)	D_(mm)	E	F
A01	2002	364	16	1	1 1
A02	2002	364	16	1	1 1
A03	318	364	16	1	1 1
A04	318	364	16	1	1 1
A05	318	344	16	2	1 1
A30	659	328	3	1	1 1
A31	659	328	3	2	1 1
A40	2000	348	16	1	1 1

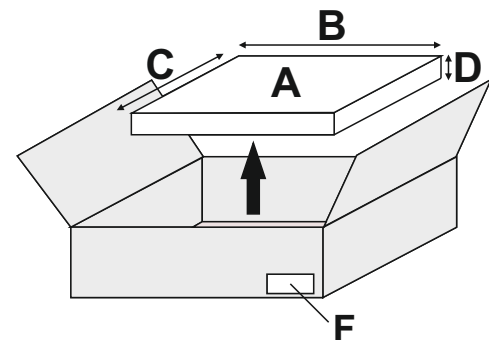
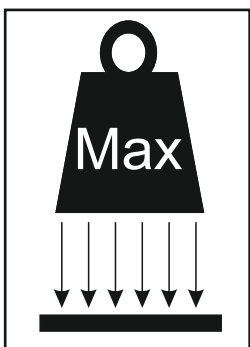

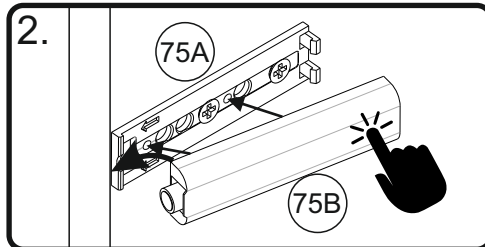
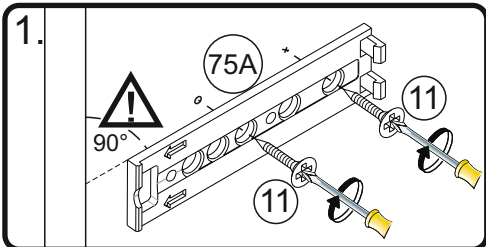
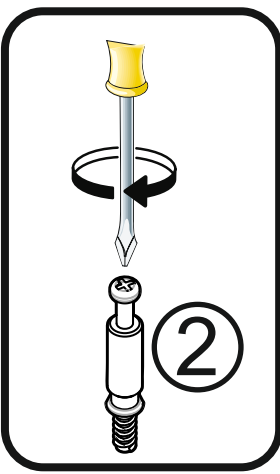
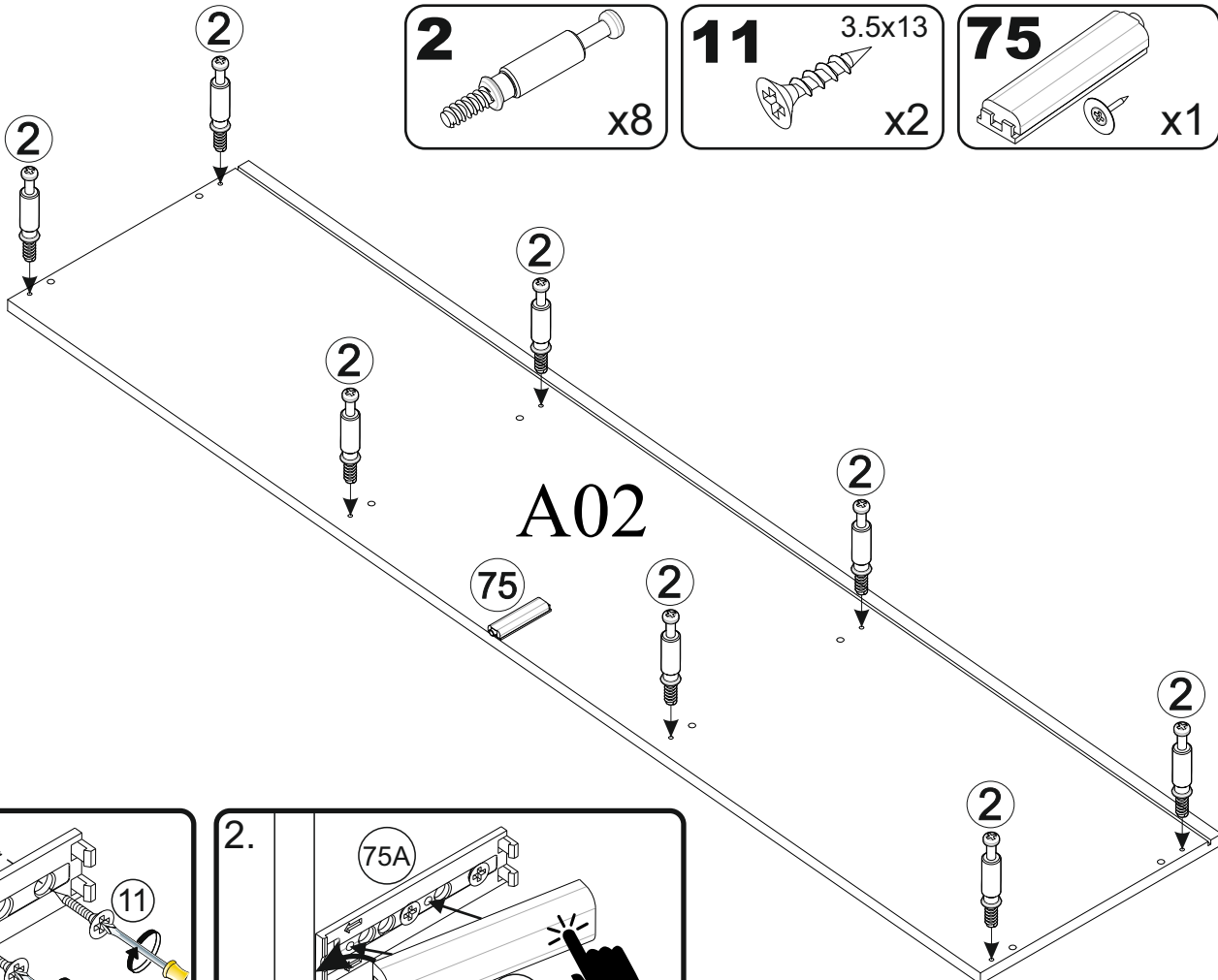
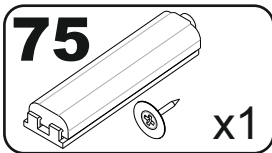
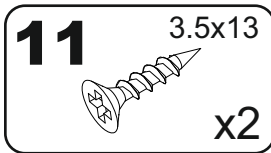
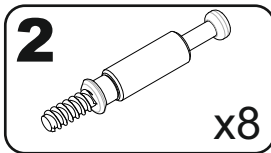

1

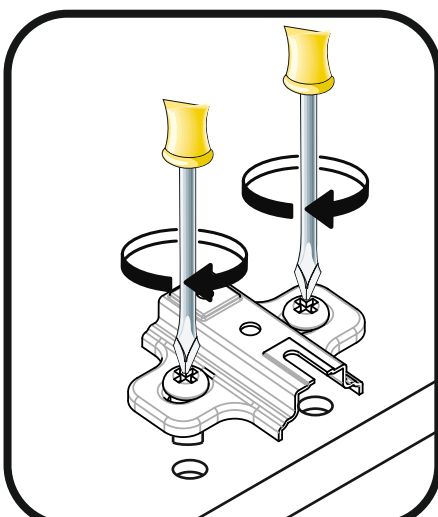
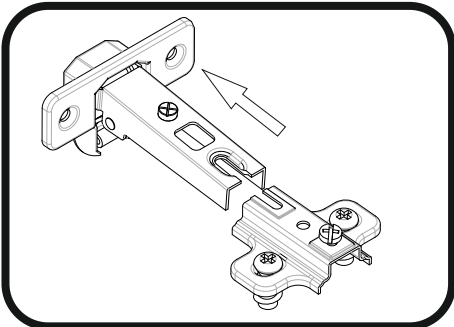
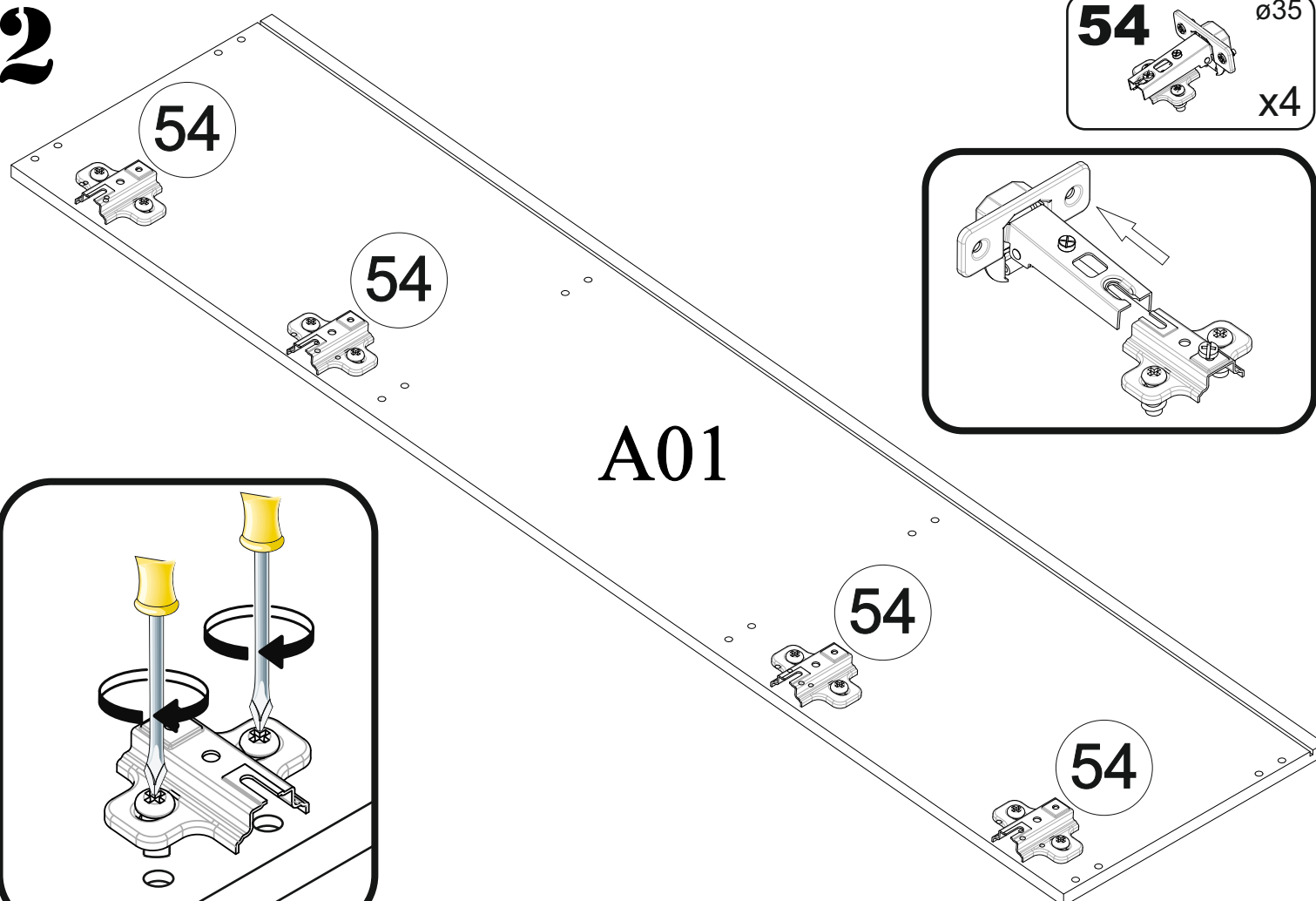
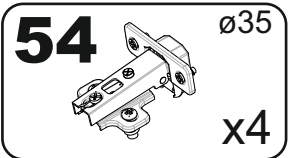

2



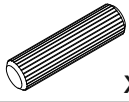

5

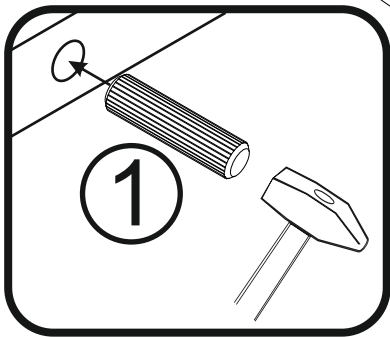
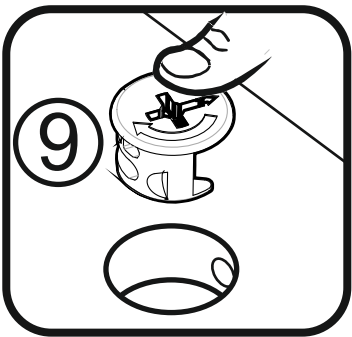
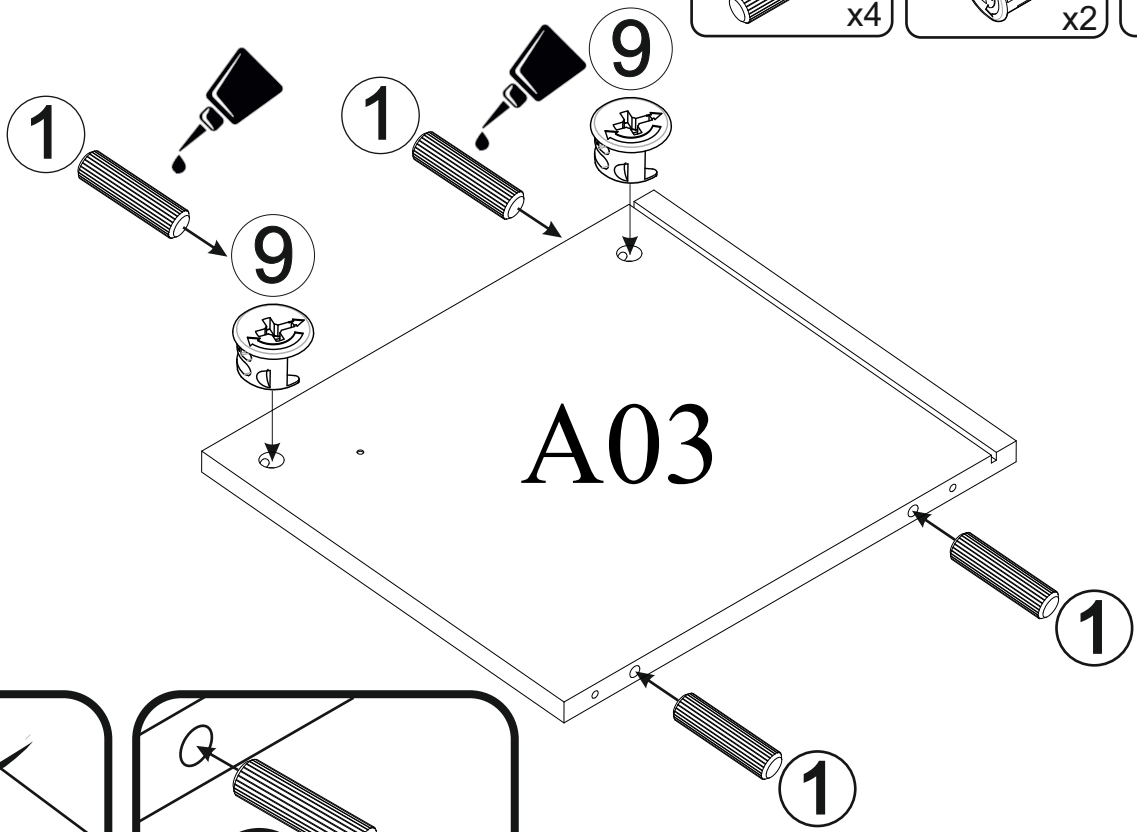
- 1  x4
- 9  ø15 x2
- 32  x1

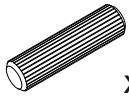

6

- 1  x4
- 9  ø15 x2
- 32  x1

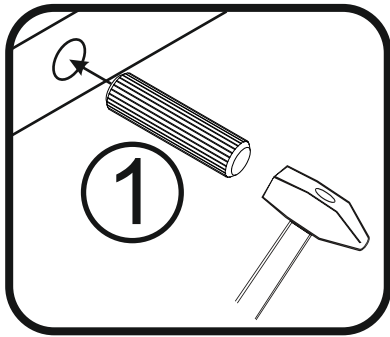
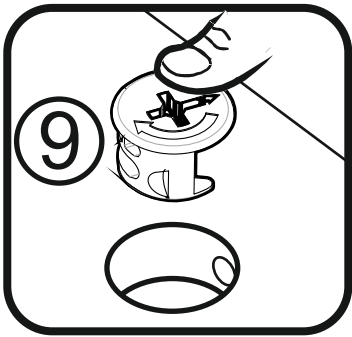
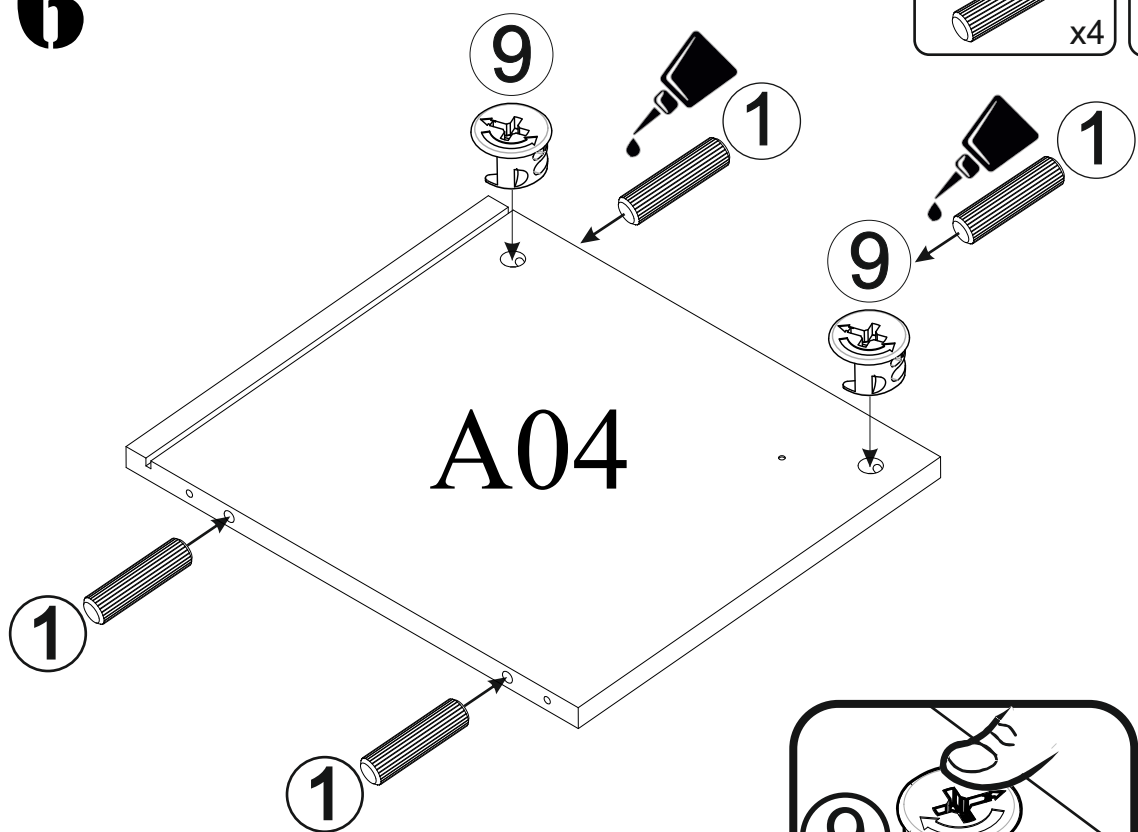

7

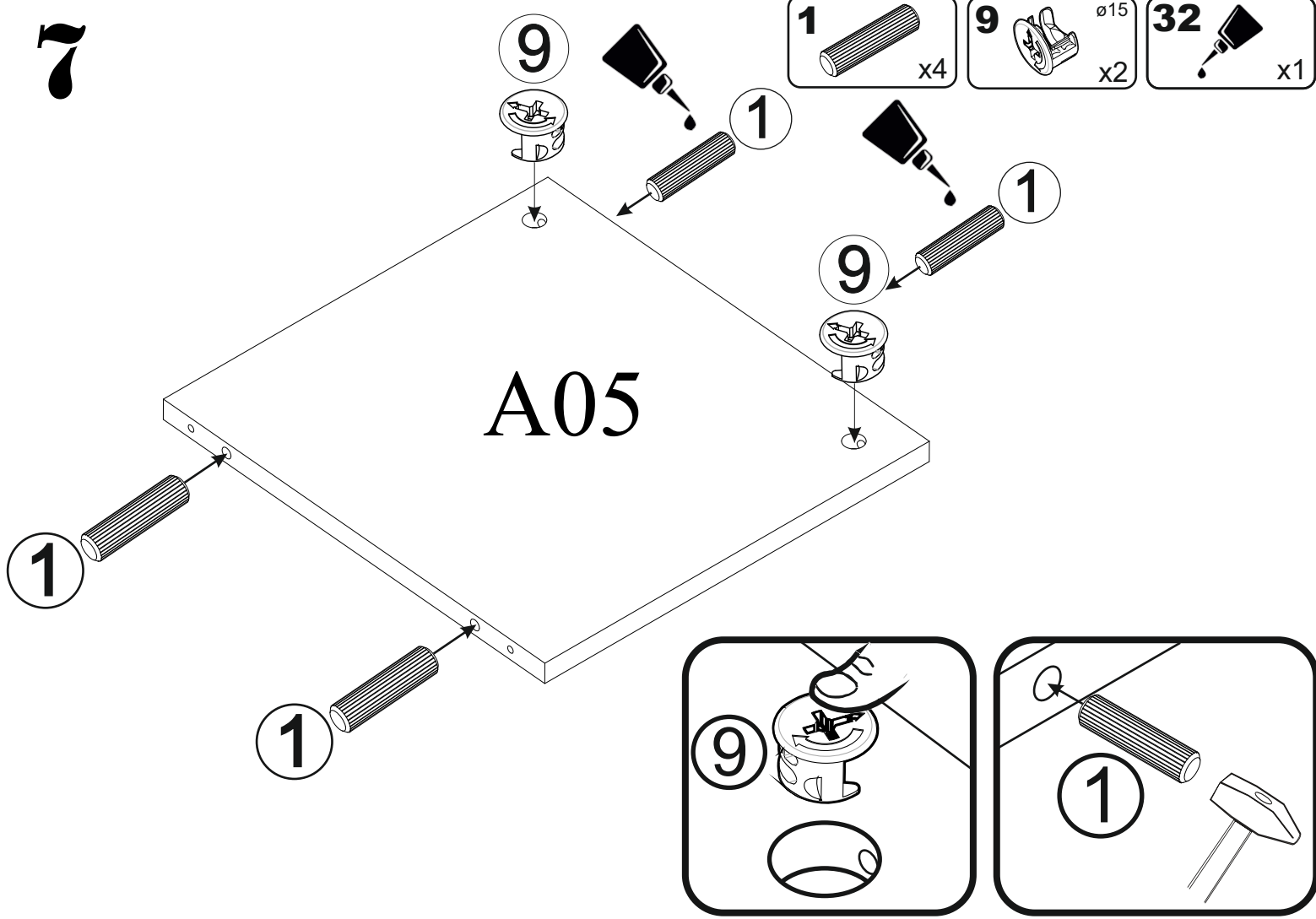

8

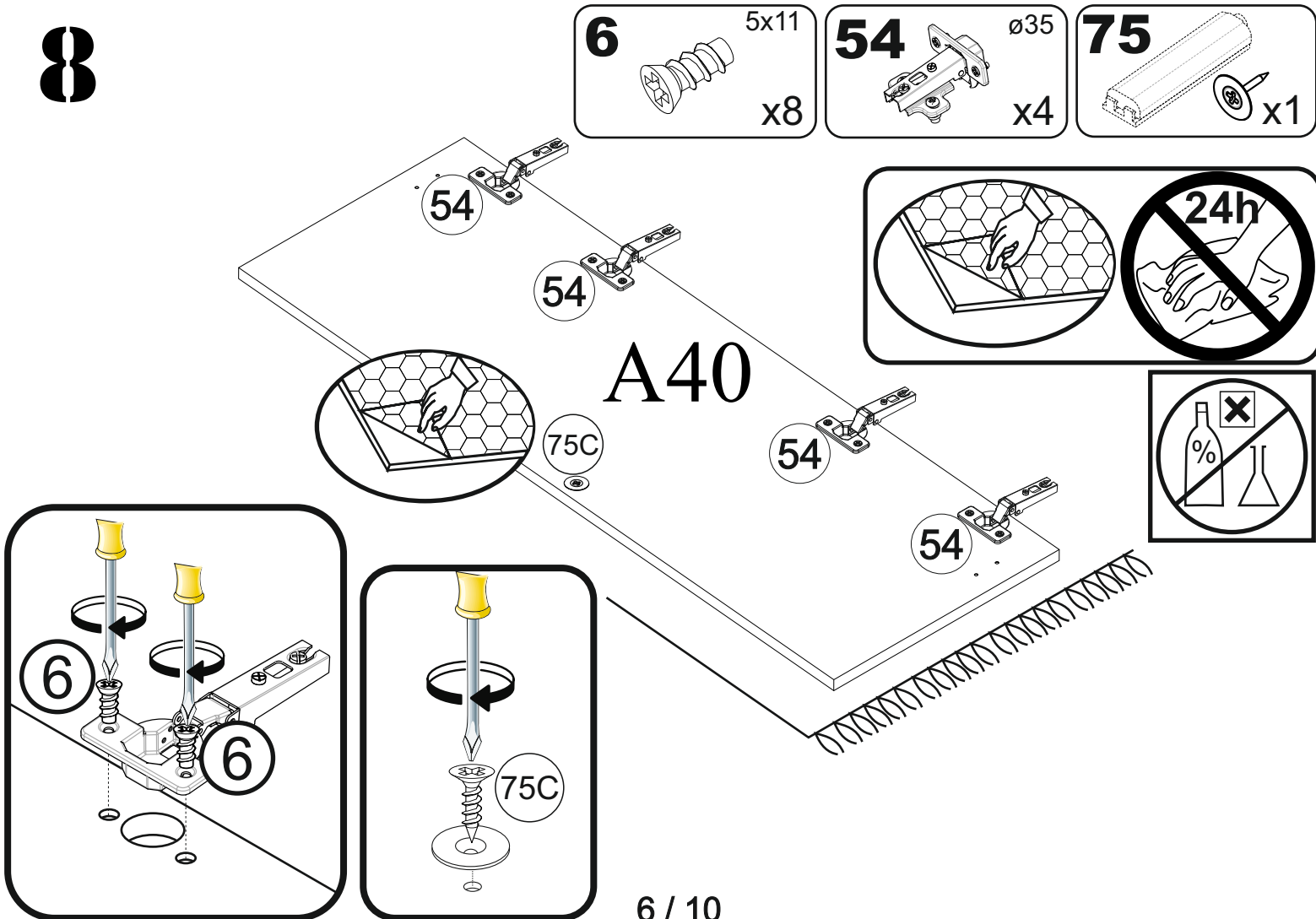

9

9A  x8

32  x1

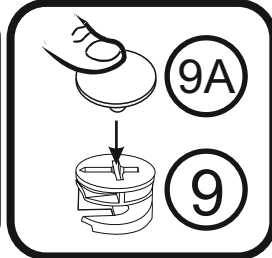
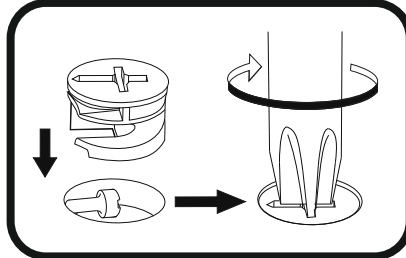
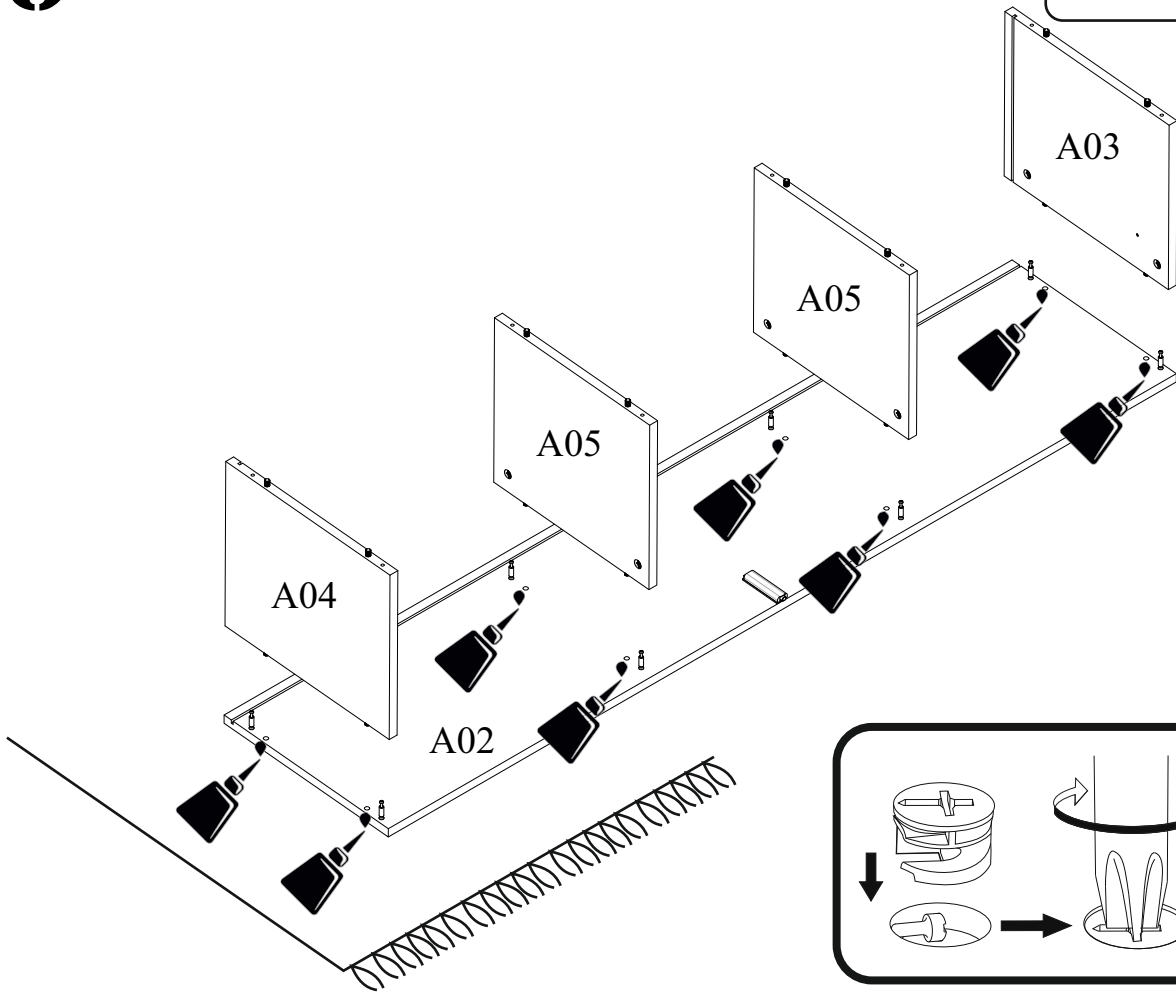

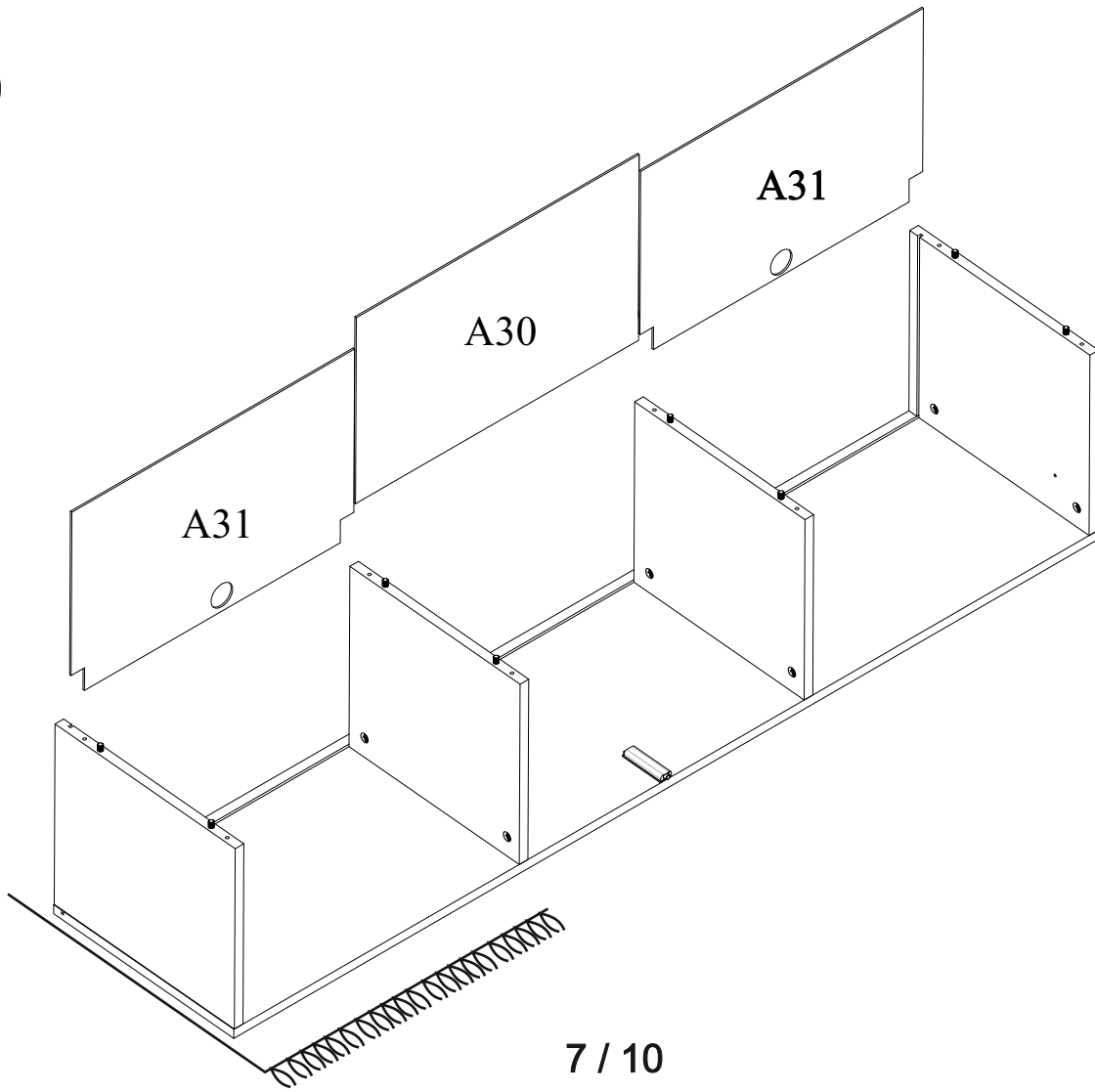

10



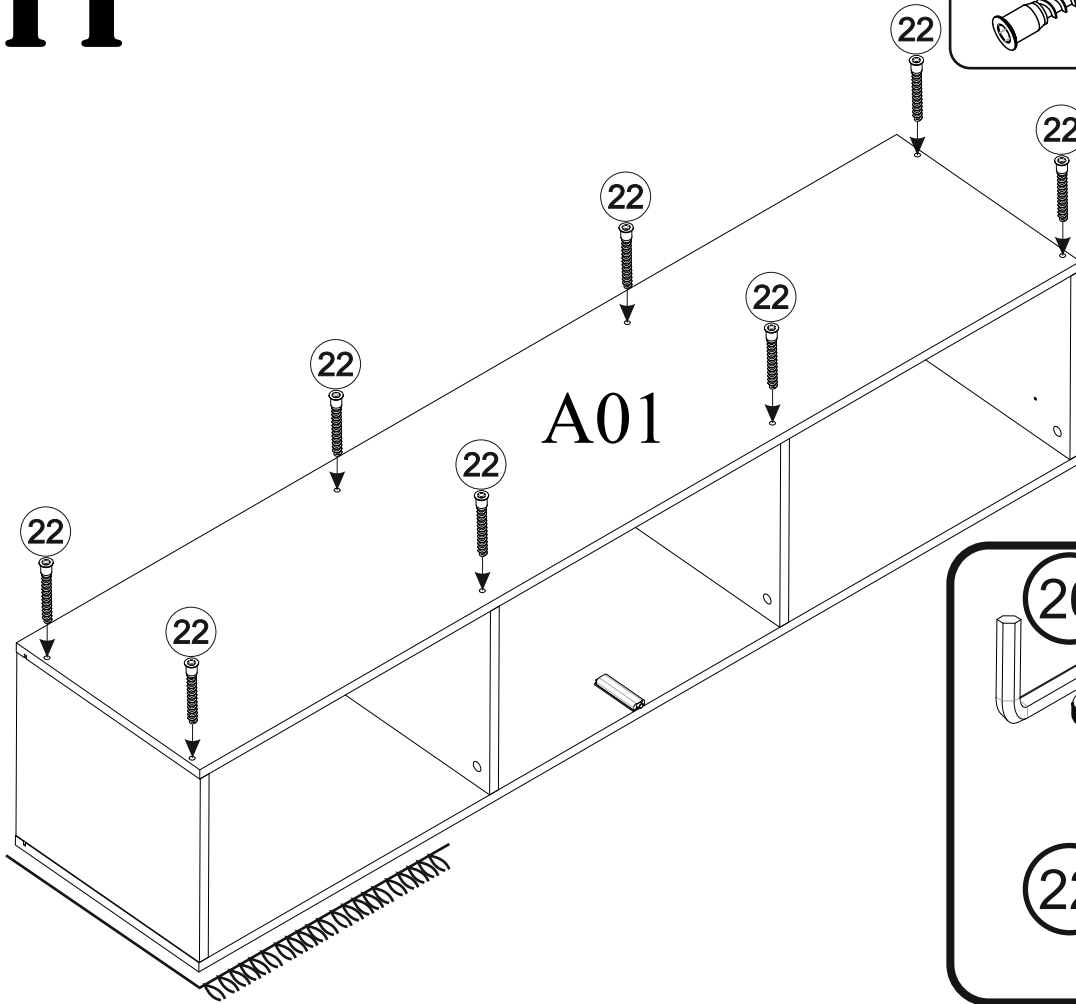

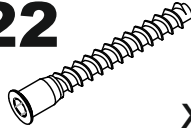

11

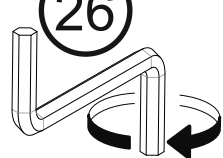

22  x8

22A  x8

26  

22A  

12

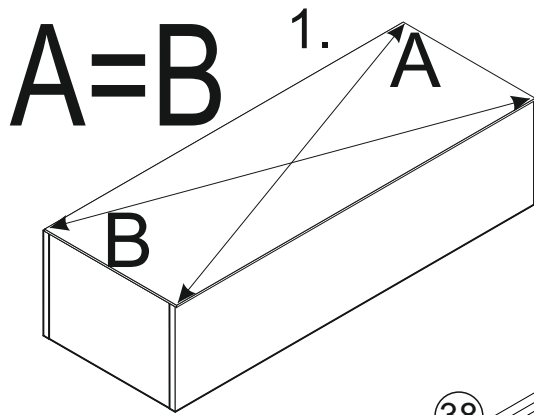

35  x6

38  x16

39  3x20 x22

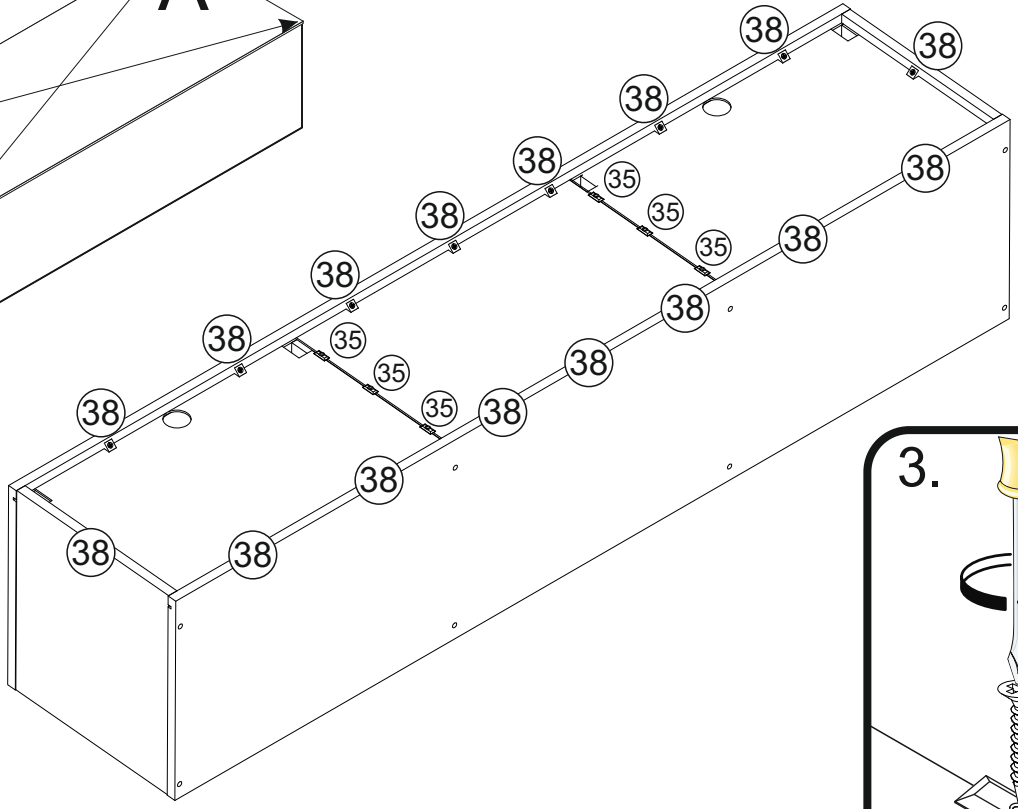

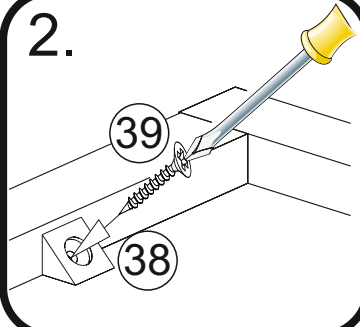
2. 

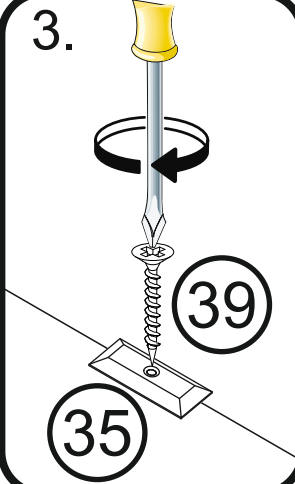
3. 

13

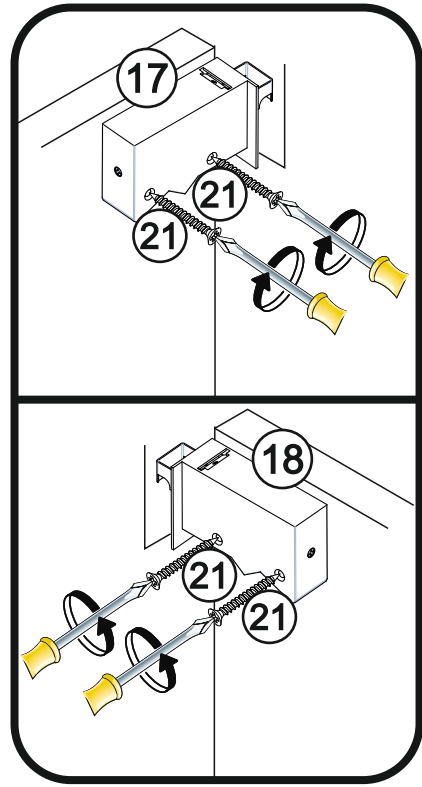
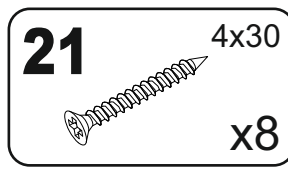
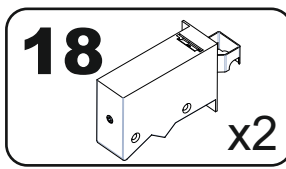
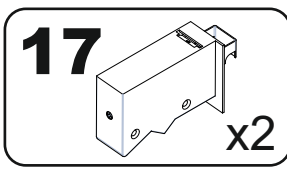
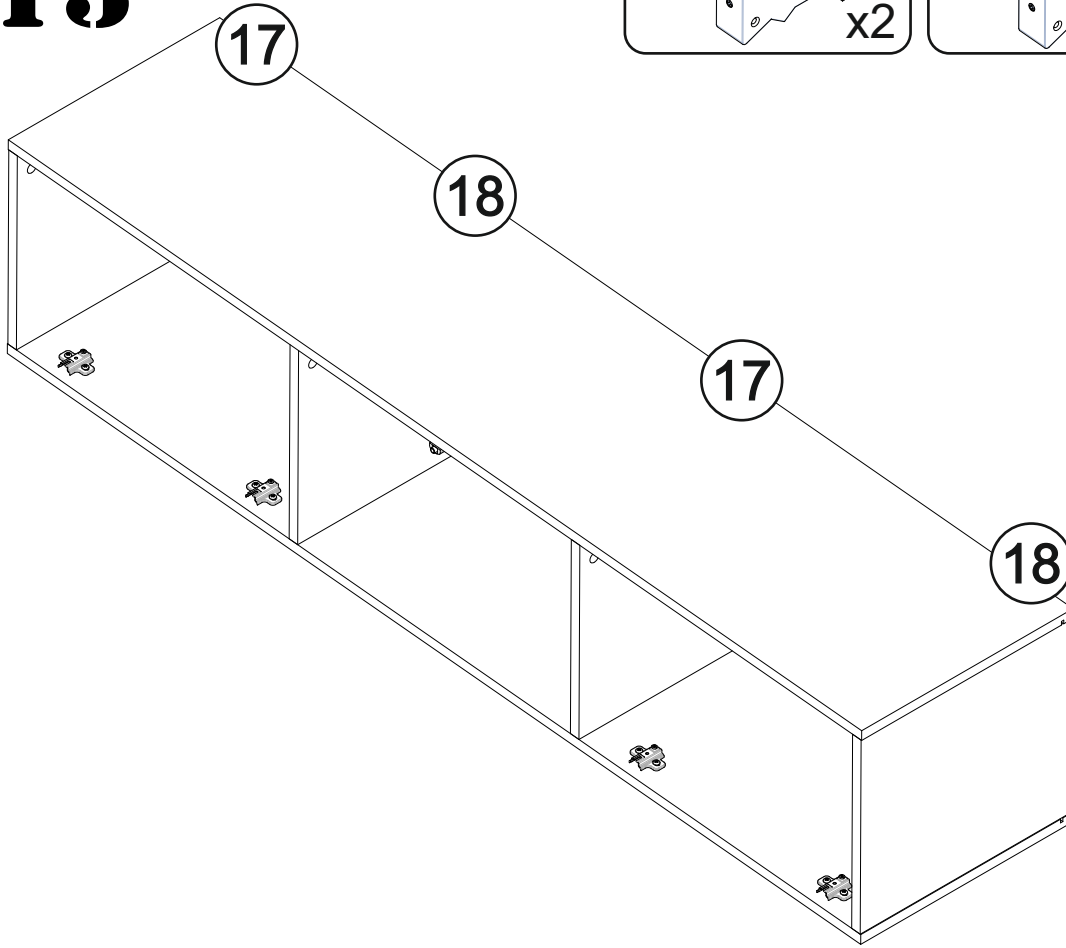

14

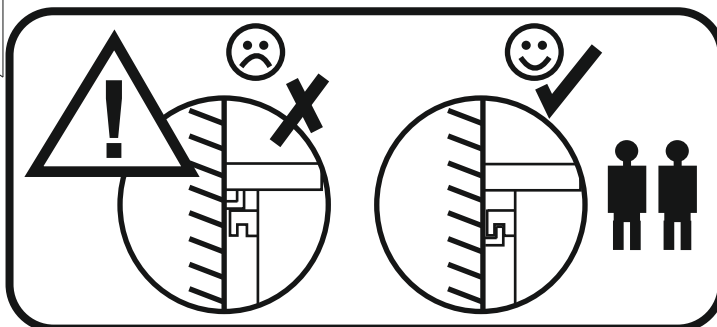
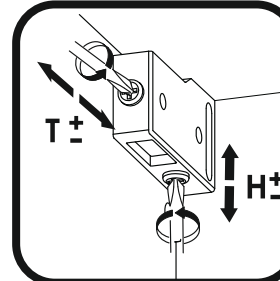
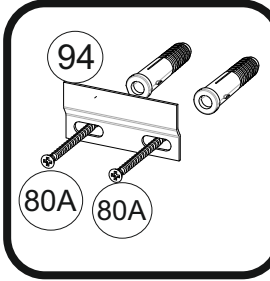
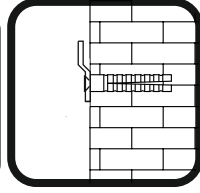
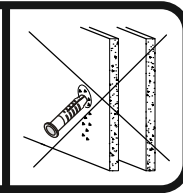
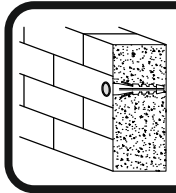
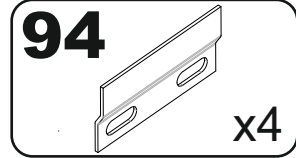
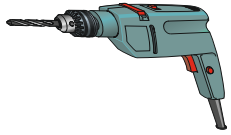
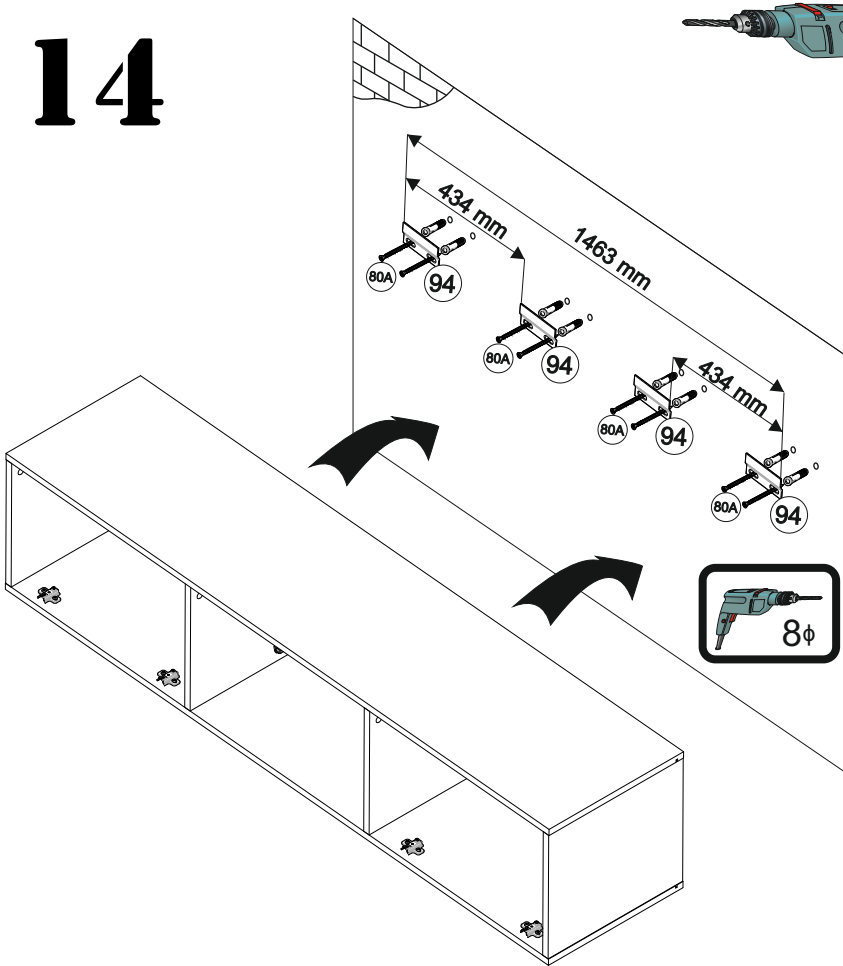

15

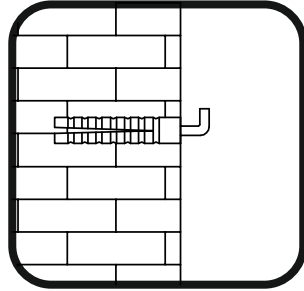
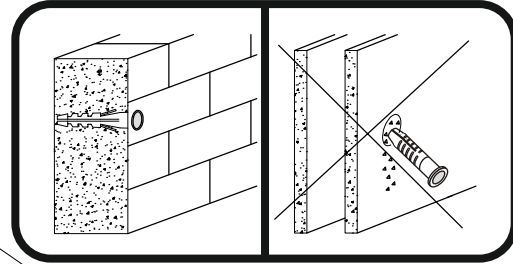
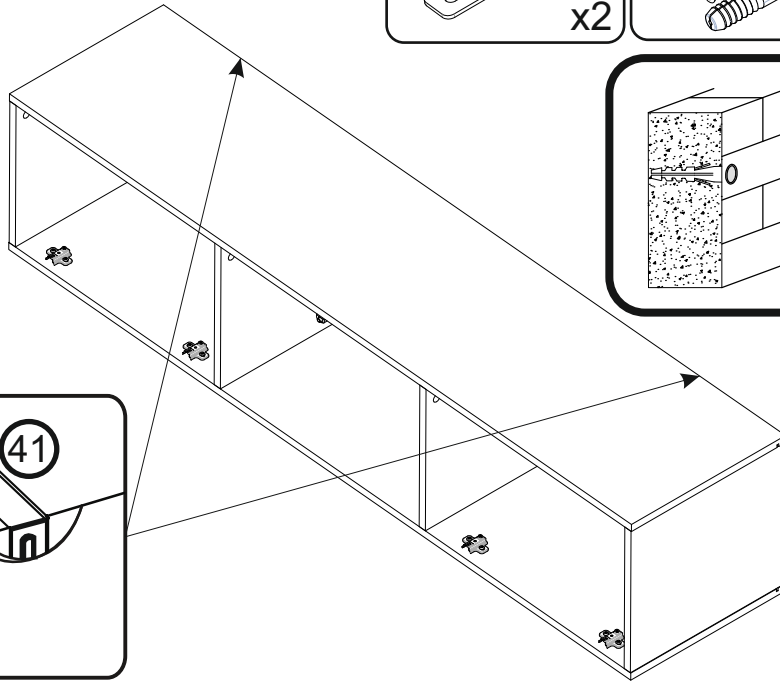
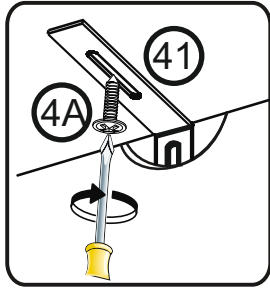
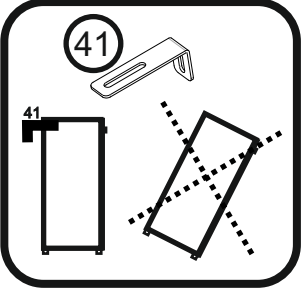
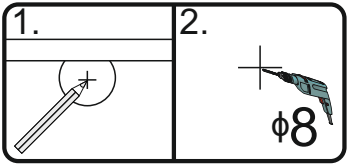
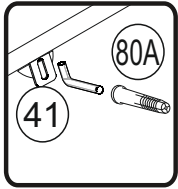
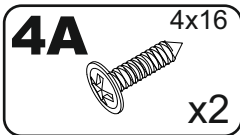
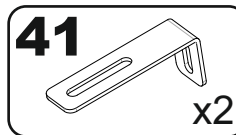

16

