

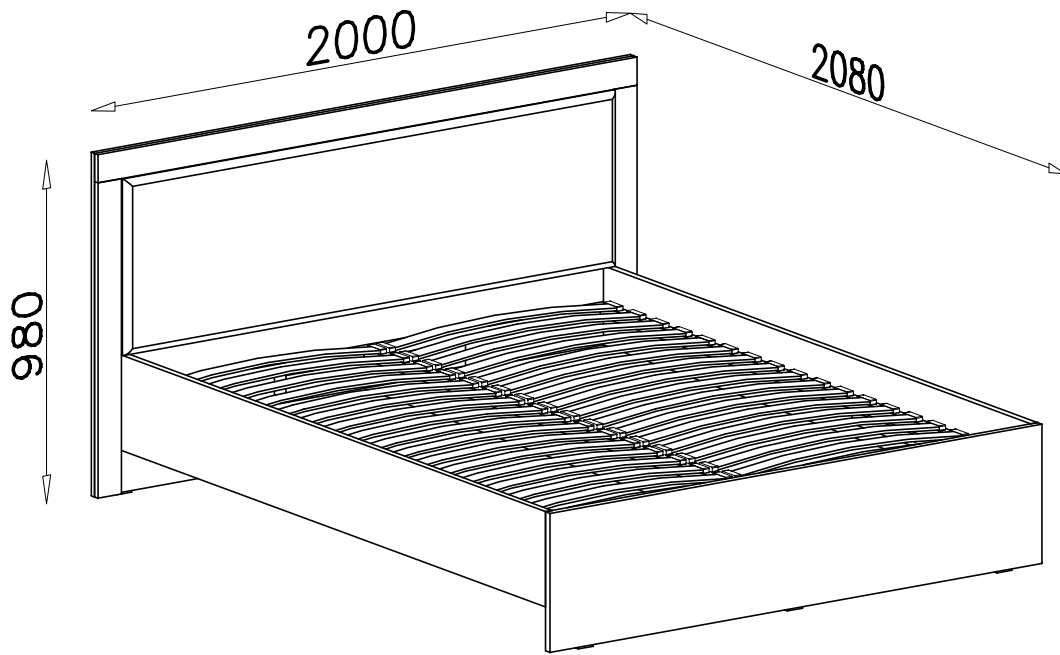

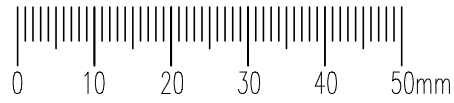

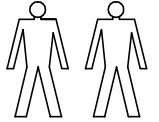

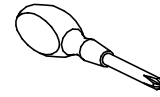

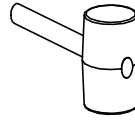
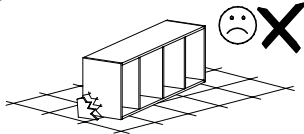
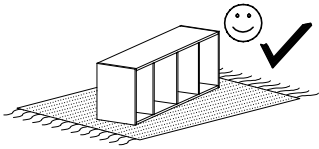

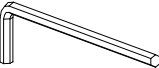

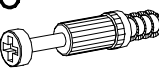
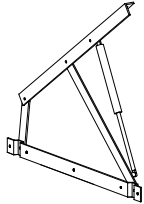
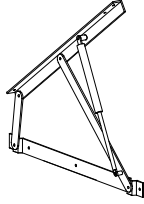
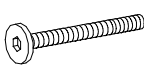
SMART SR 6/180

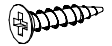
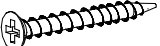

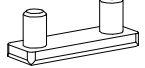
Q5  100mm x1	M8  M6x85 x1	W3  6mm x1		
Q6  128mm x1	K1  ø15x12 x12	K10  x12	7L  x1	7P  x1
N34  M6x50 x12	N35  M6x25 x18	N36  M6x20 x10		
G11  4x20 x12	G9  3,5x35 x28	I8  x40	A5  ø7x60 x2	P3  x6
A1  ø7x50 x4	B7  ø8x30 x8	W2  x1	W1  GLUE, LEIM, LEPIDLO, LIM x1	M3  50x50x25 x2

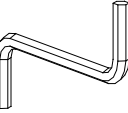

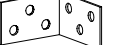
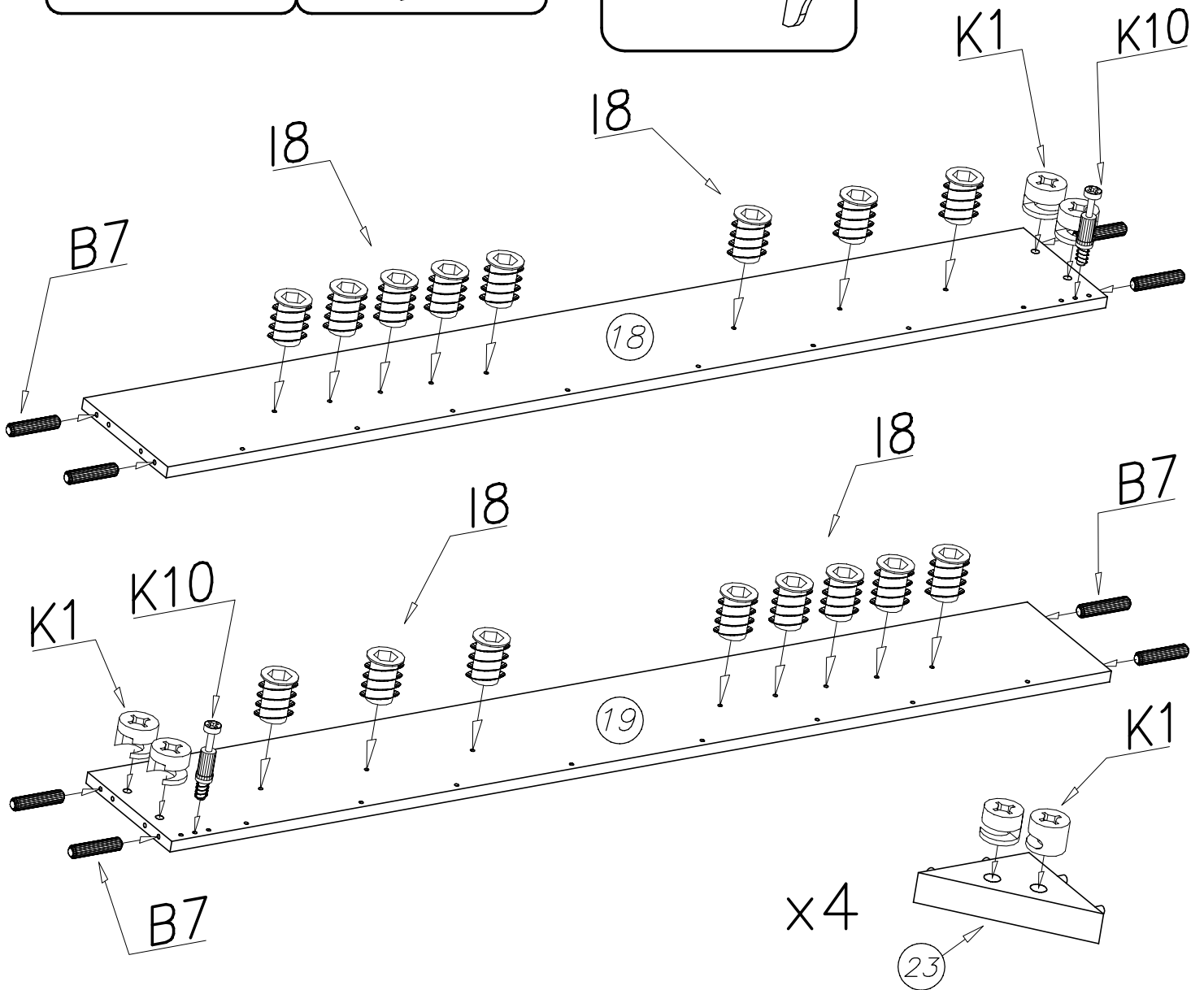
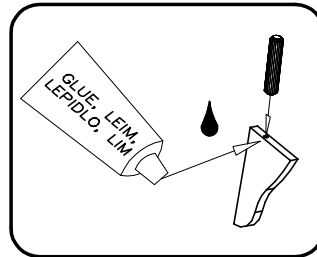
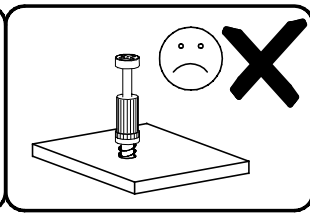
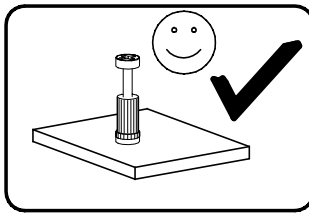
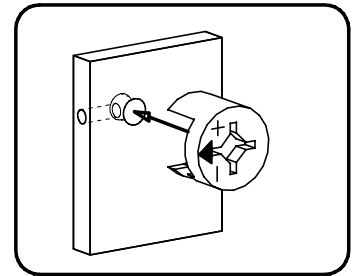
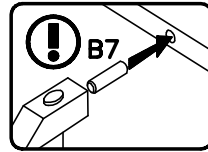
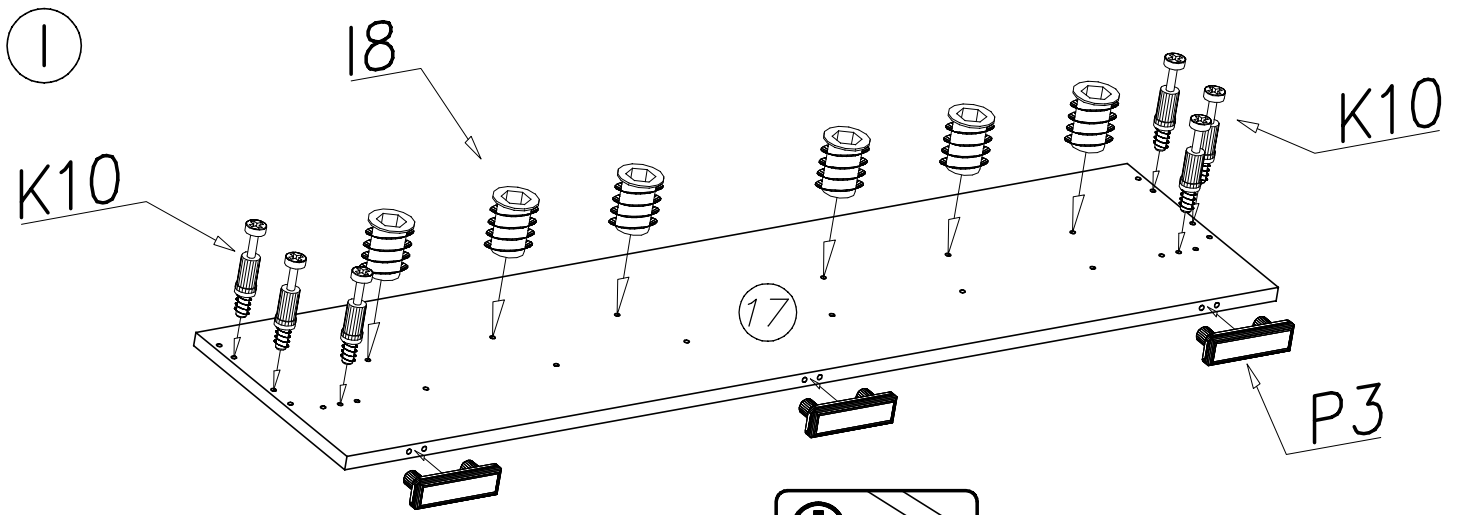
x4

23

II

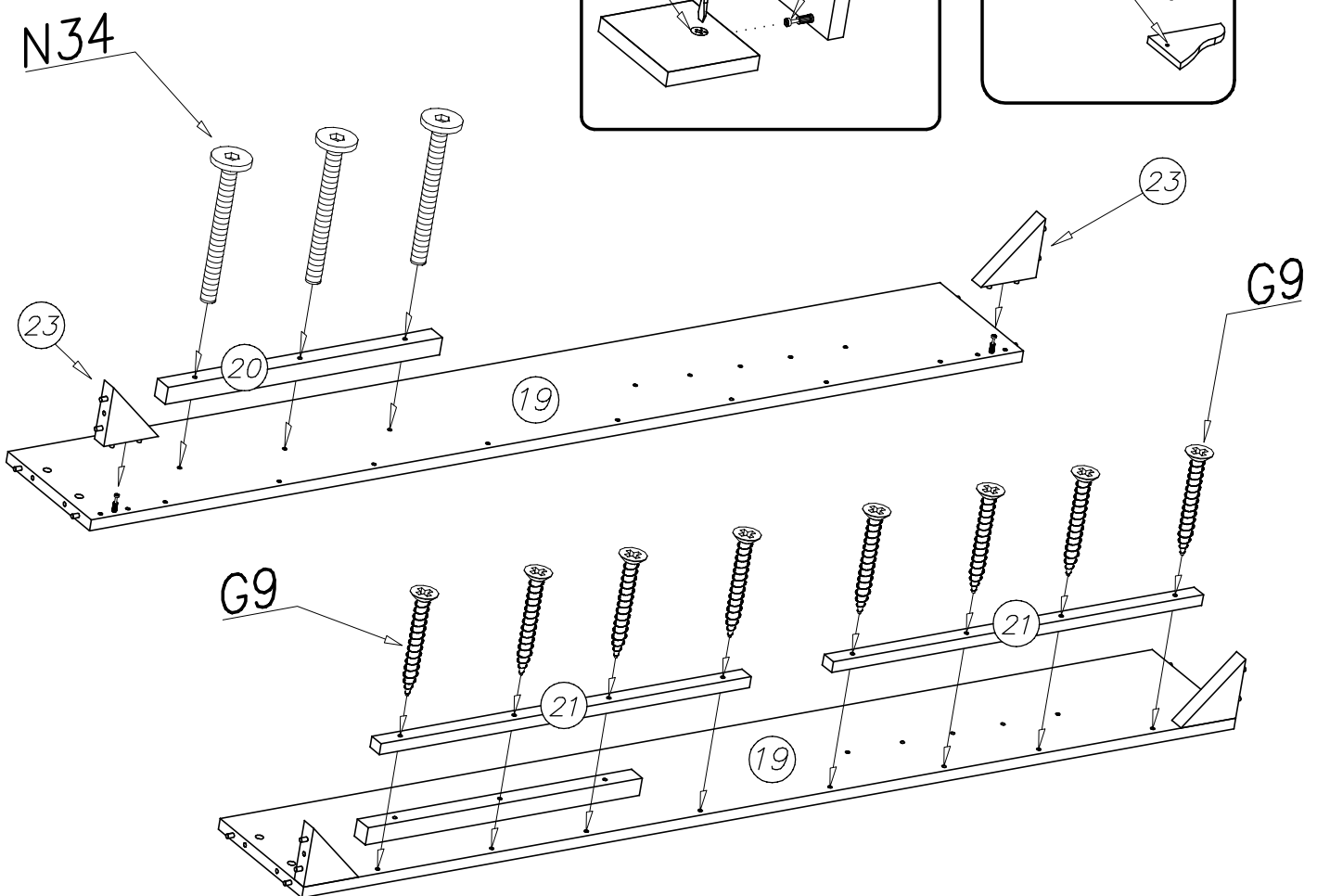
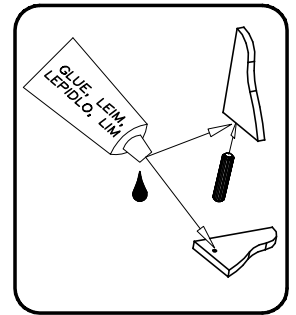
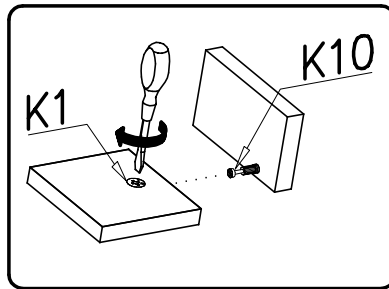
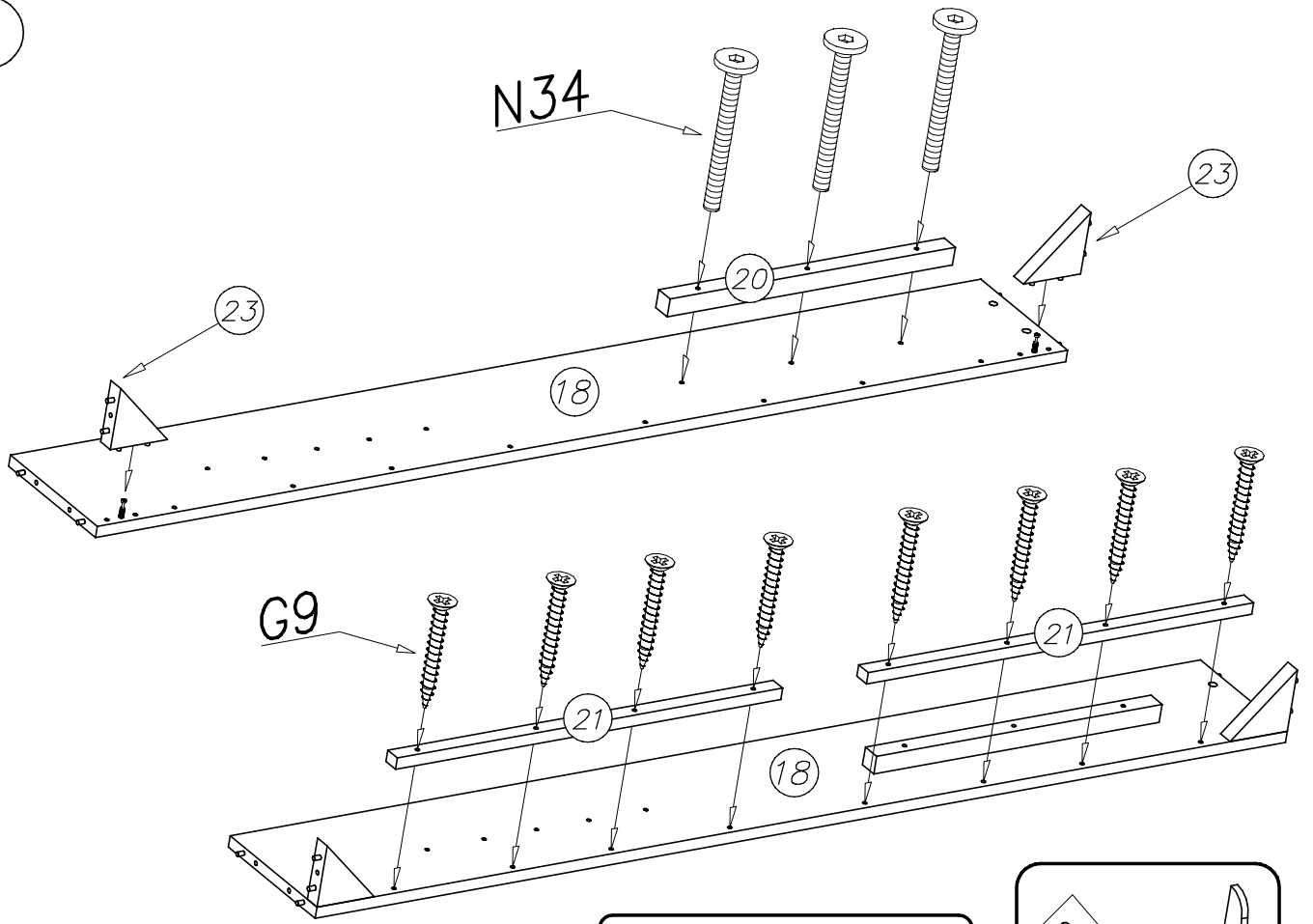

III

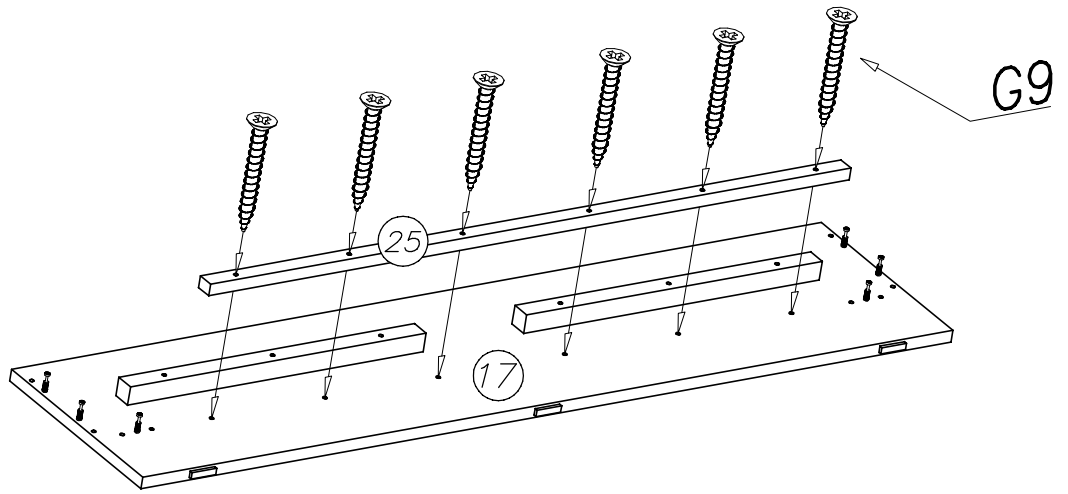
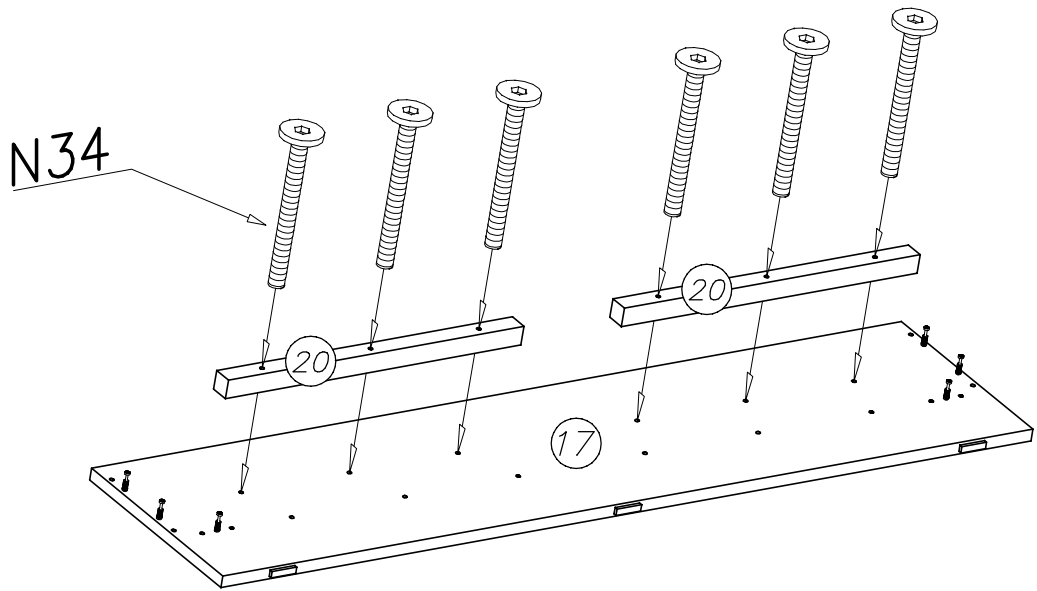

IV

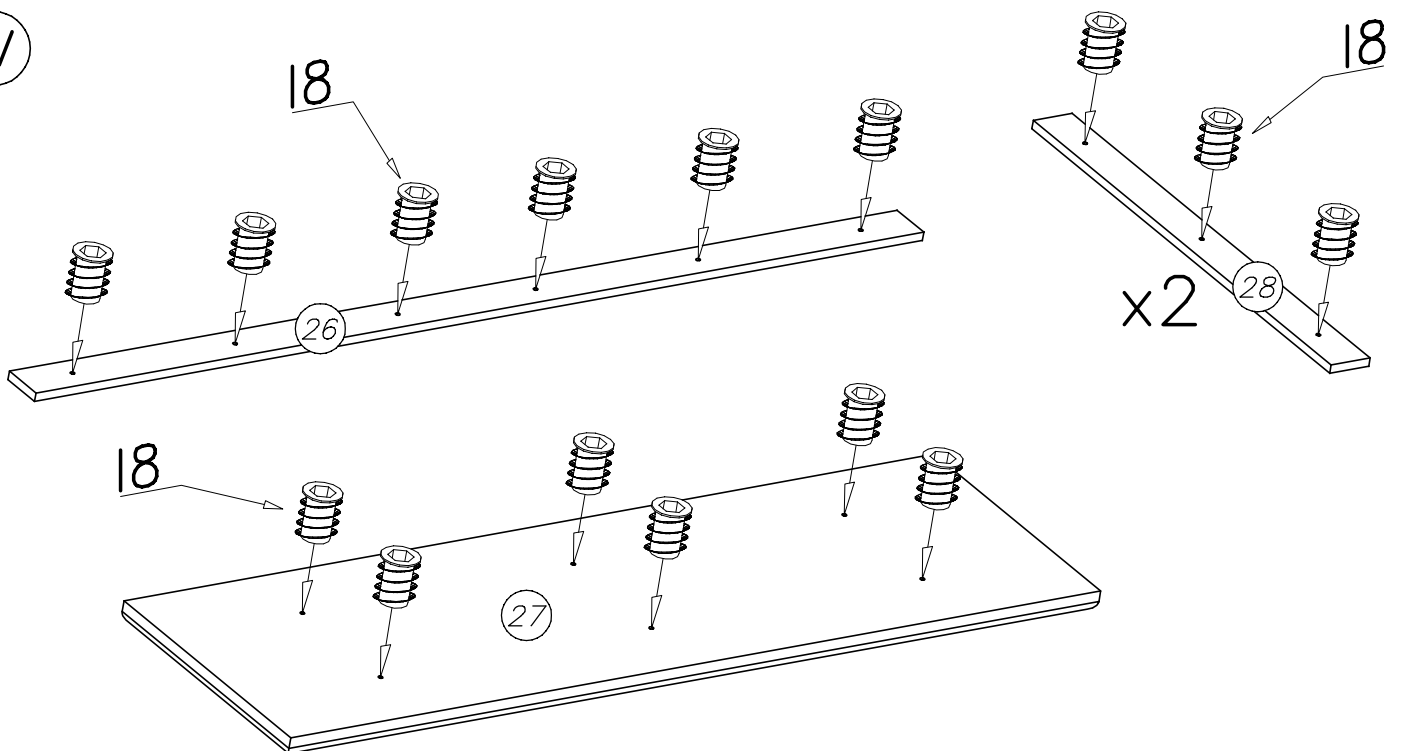

V

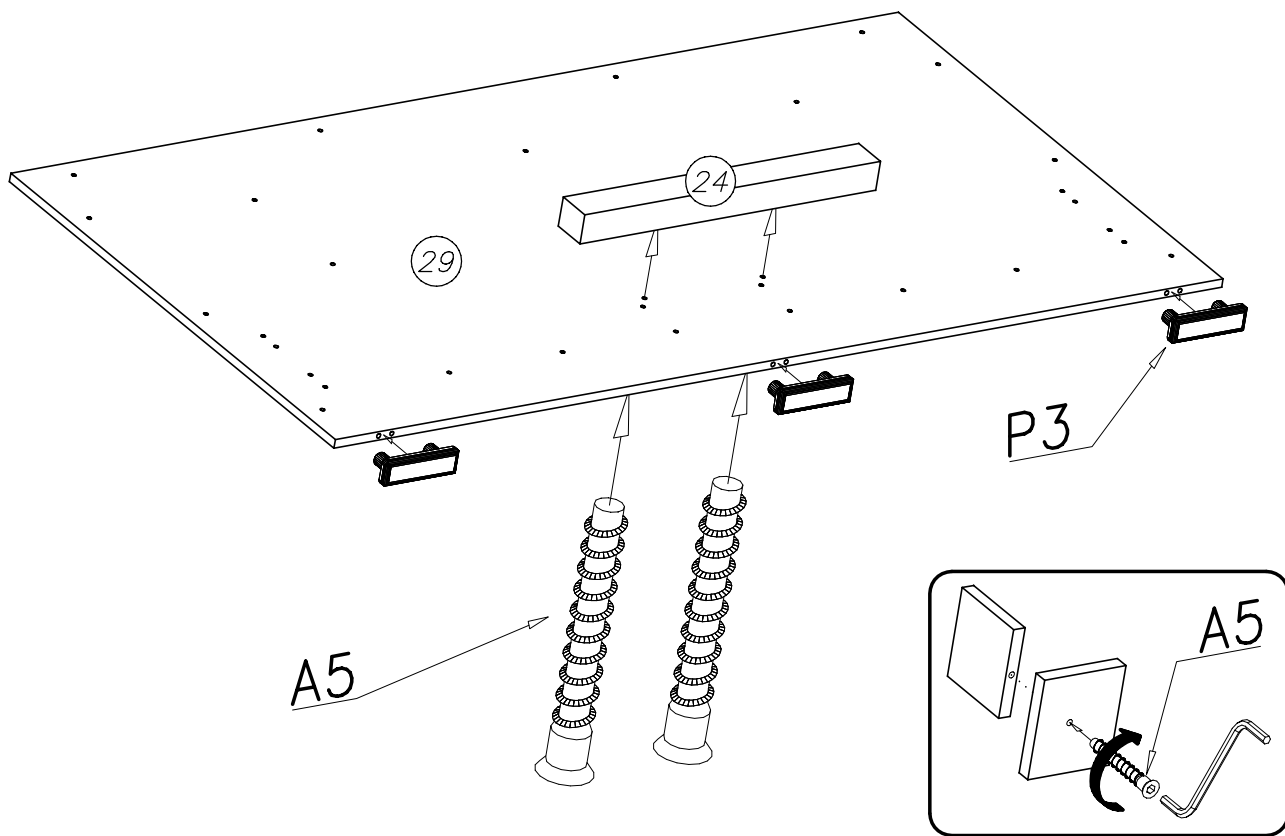

VI

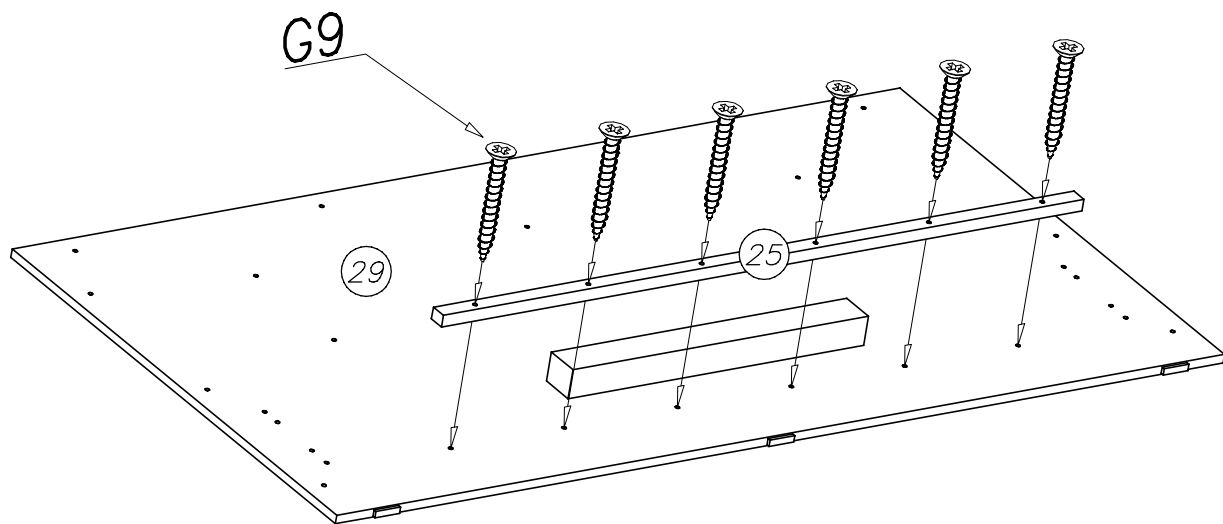

VII

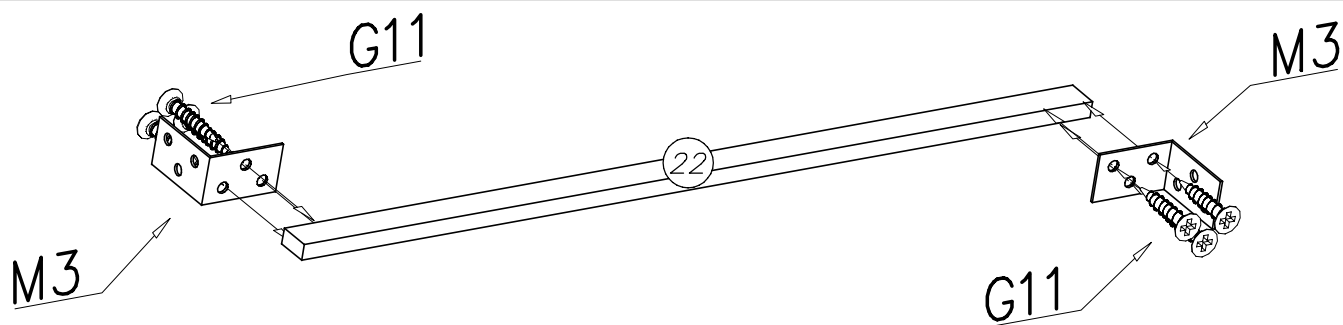

VIII

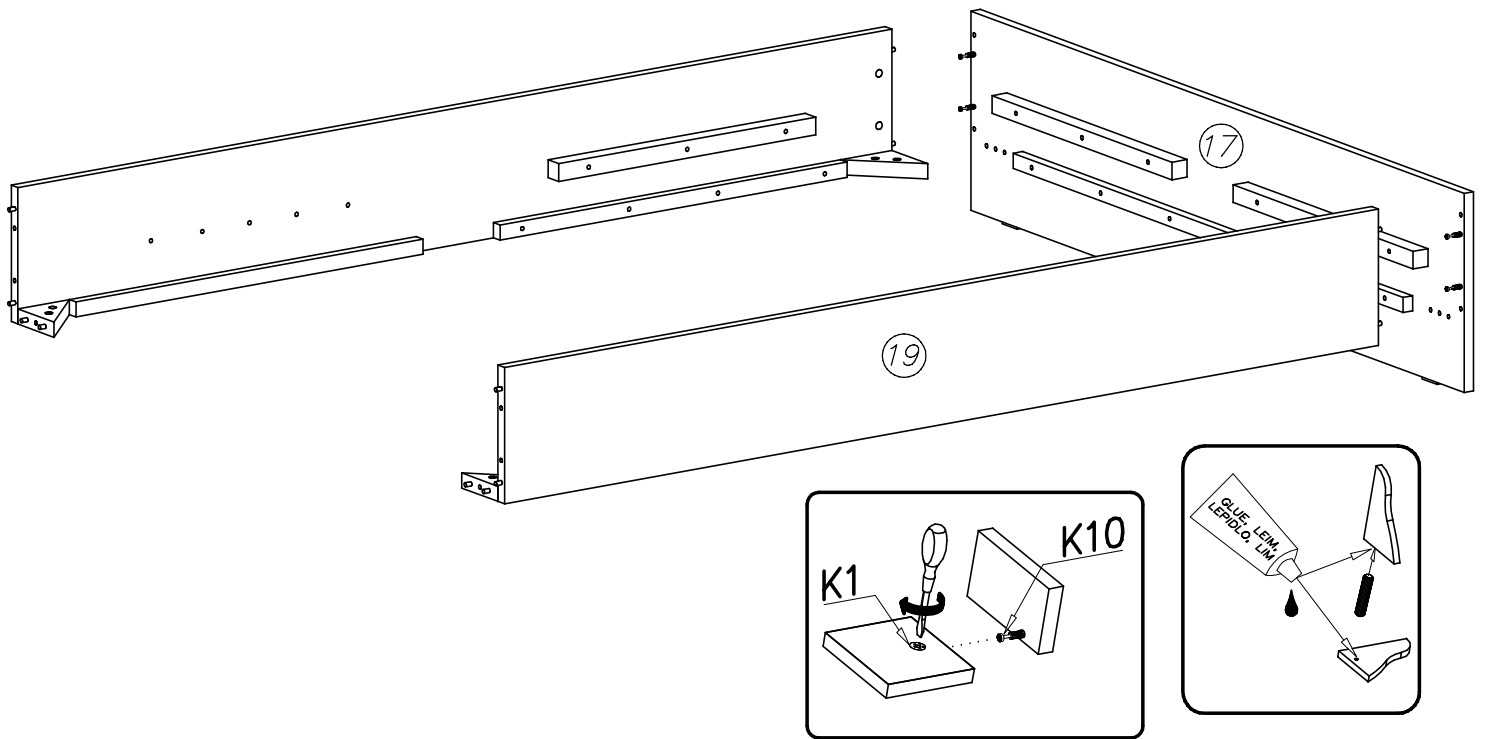

IX

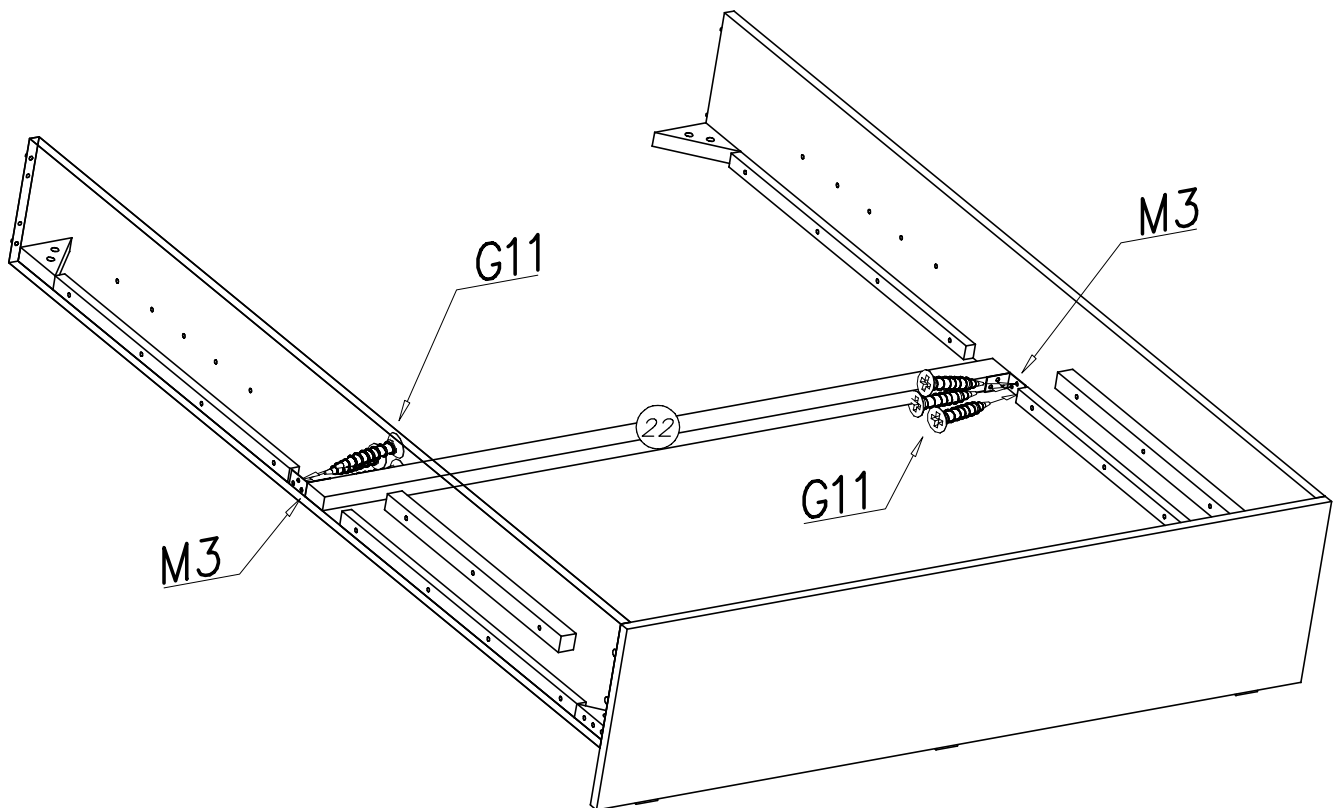

X

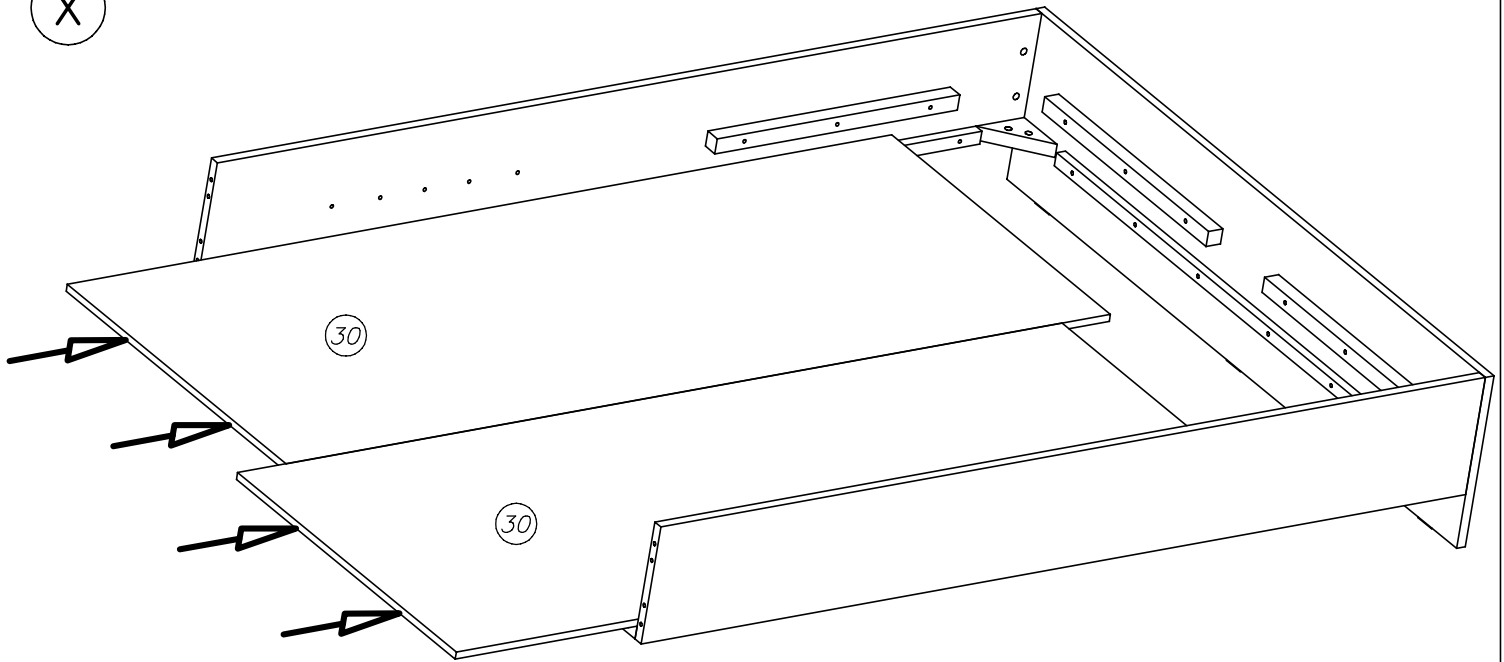

XI

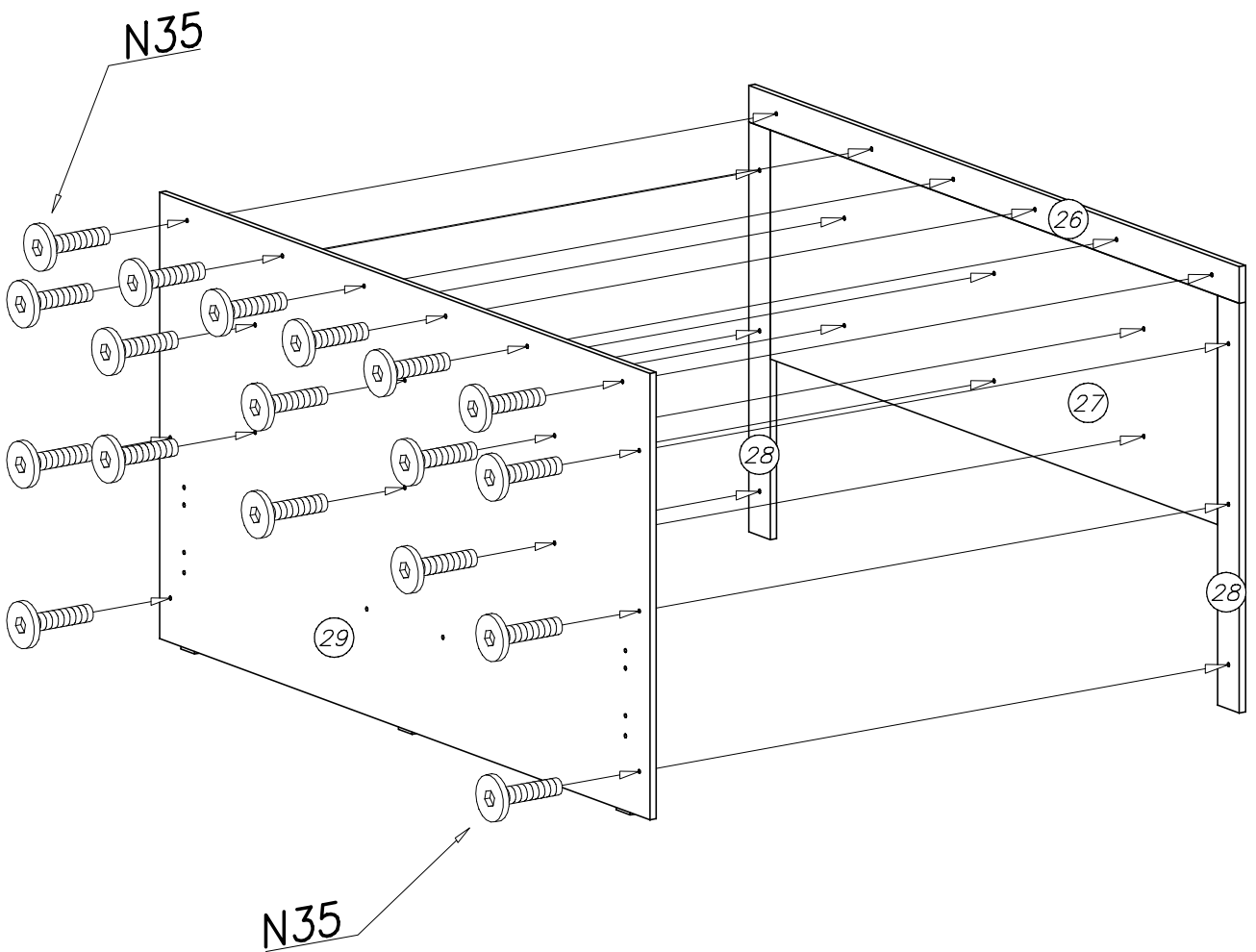

XII

