

60min

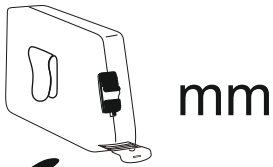

mm

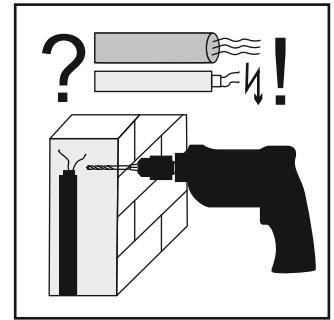
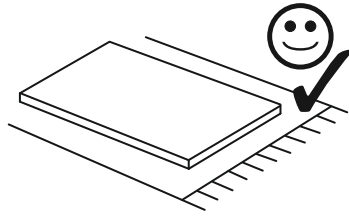
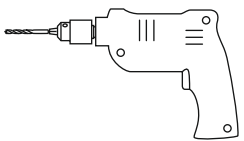
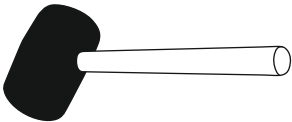

Ø10

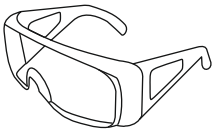

4 x

Ø10



mm

0

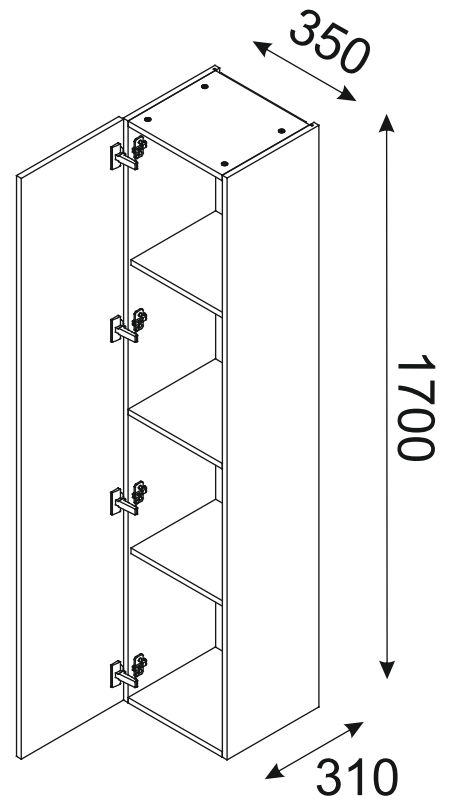
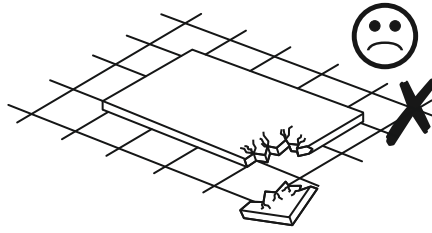

L

R

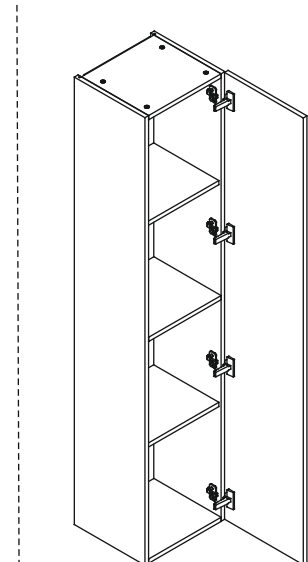
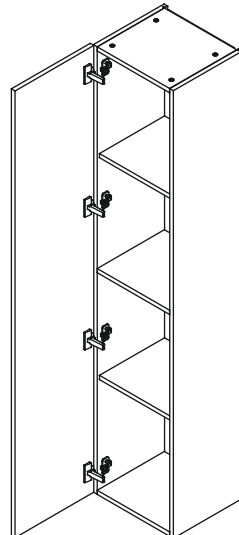

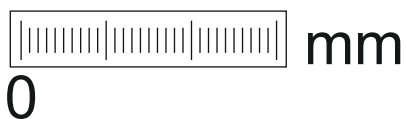
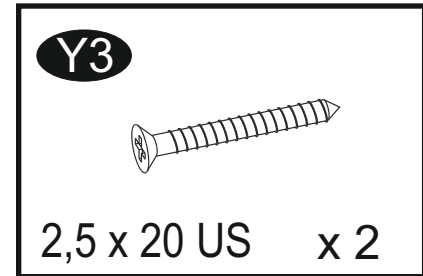
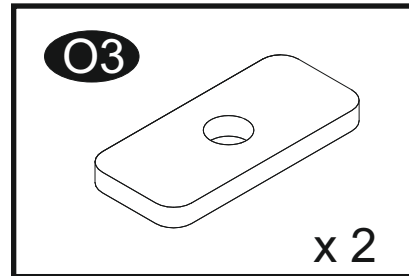
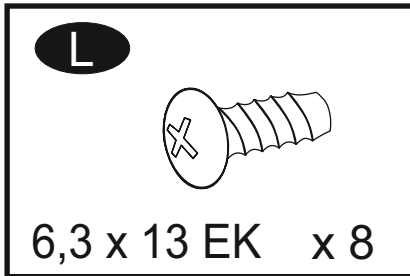
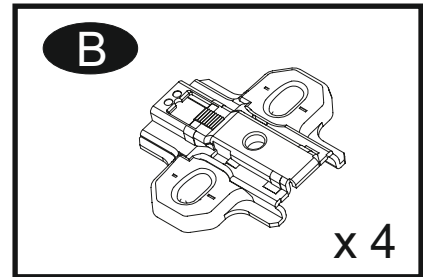
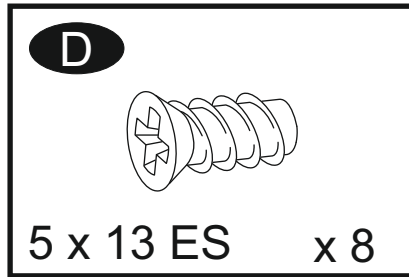
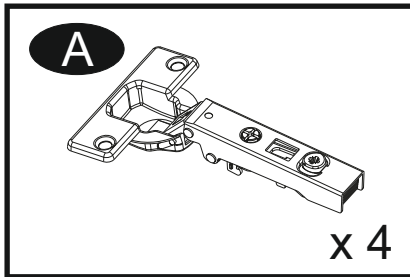
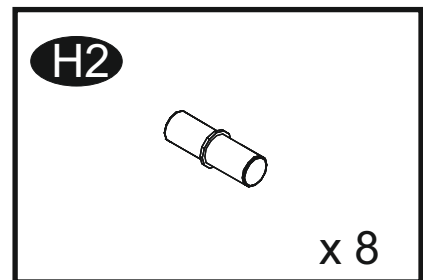
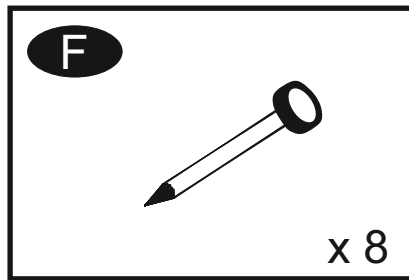
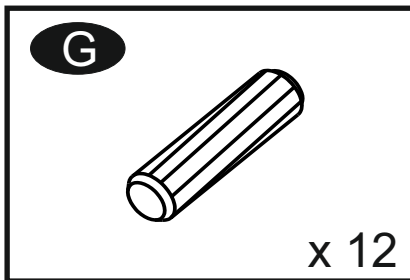
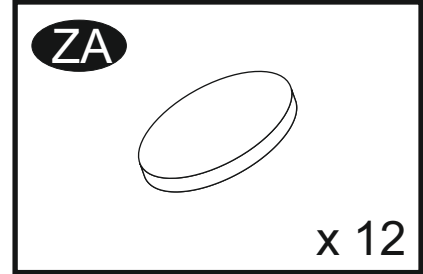
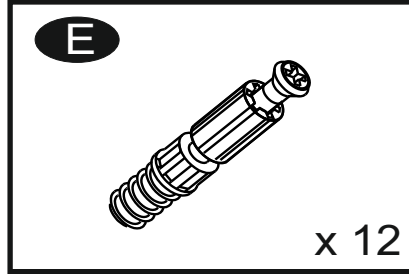
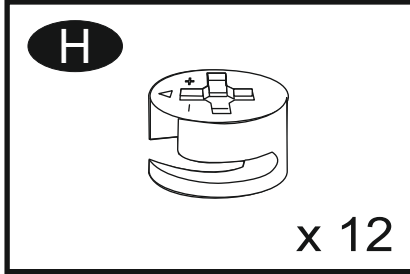
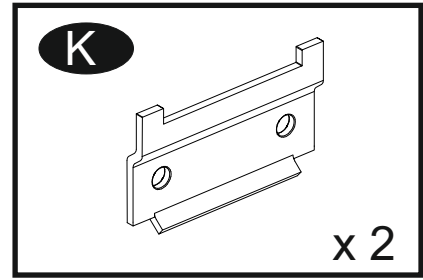
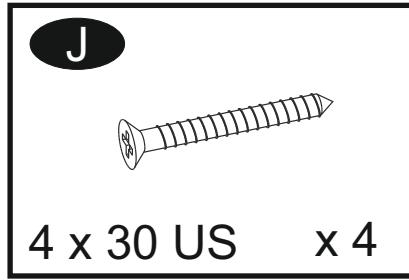
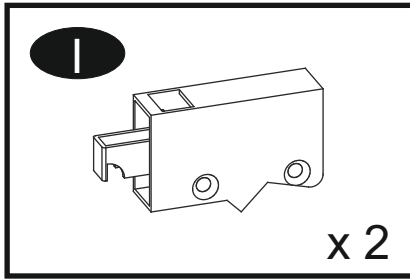

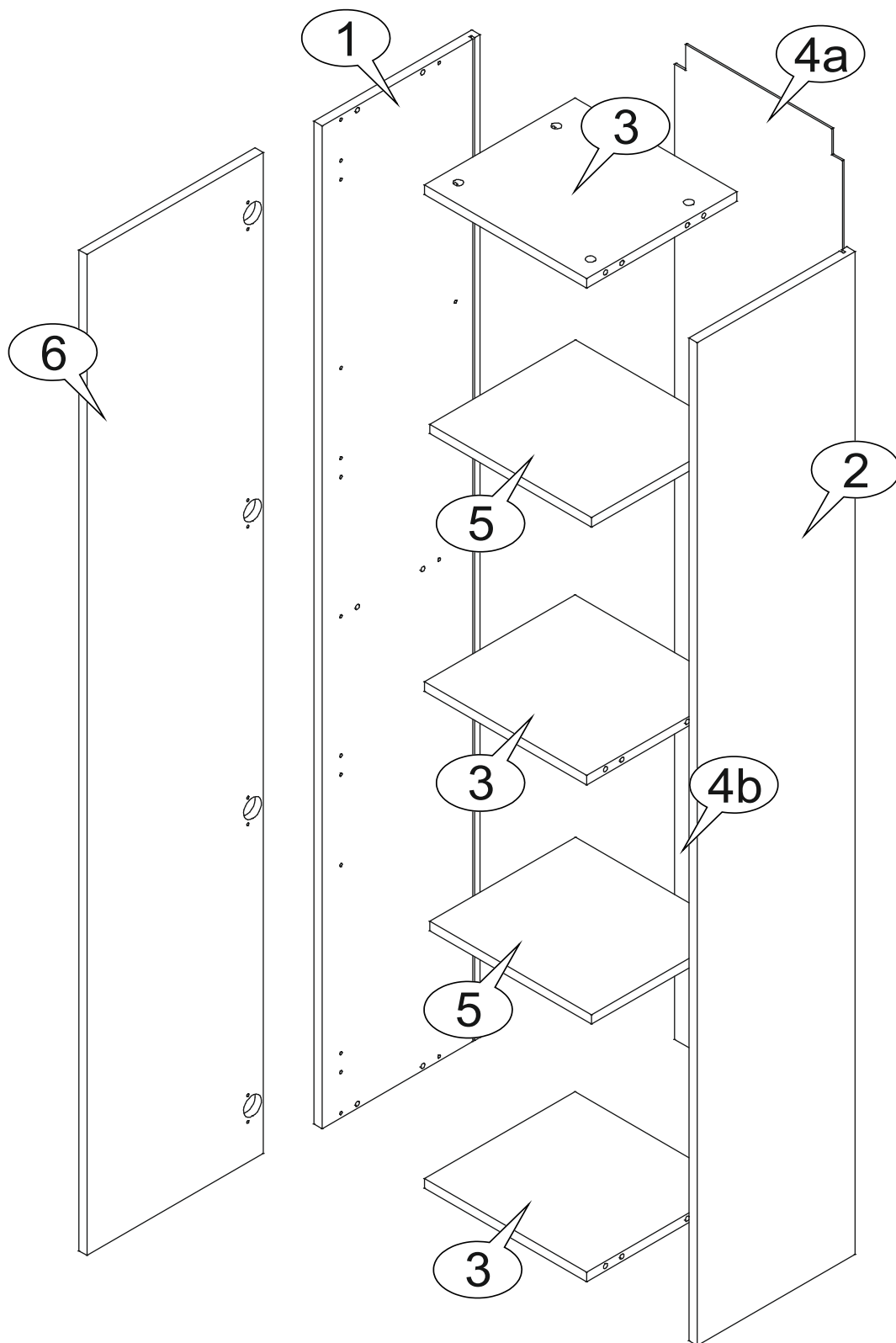

1	1700	310	x 1
2	1700	310	x 1
3	317	296	x 3
4a	847	328	x 1
4b	847	328	x 1
5	317	286	x 2
6	1696	346	x 1

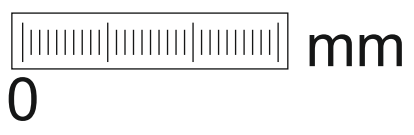

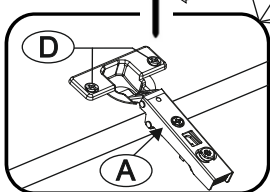
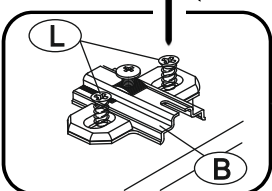
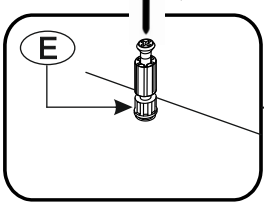
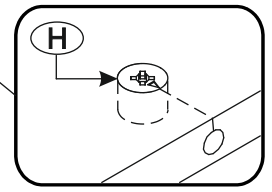
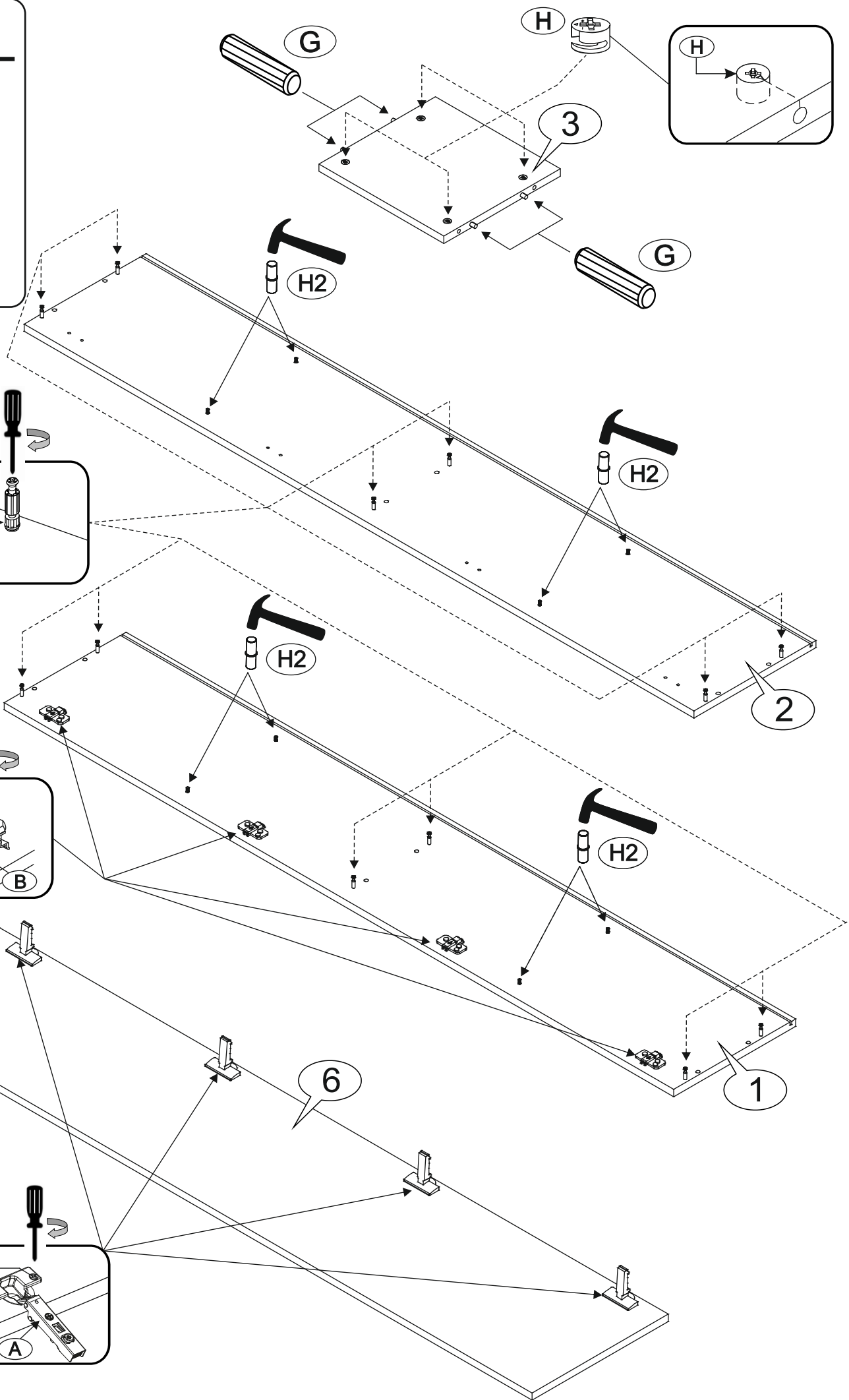
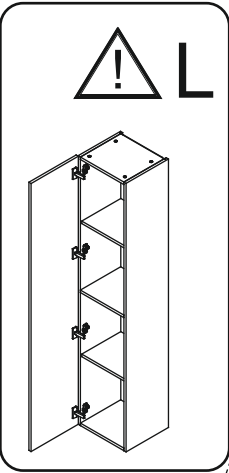

2

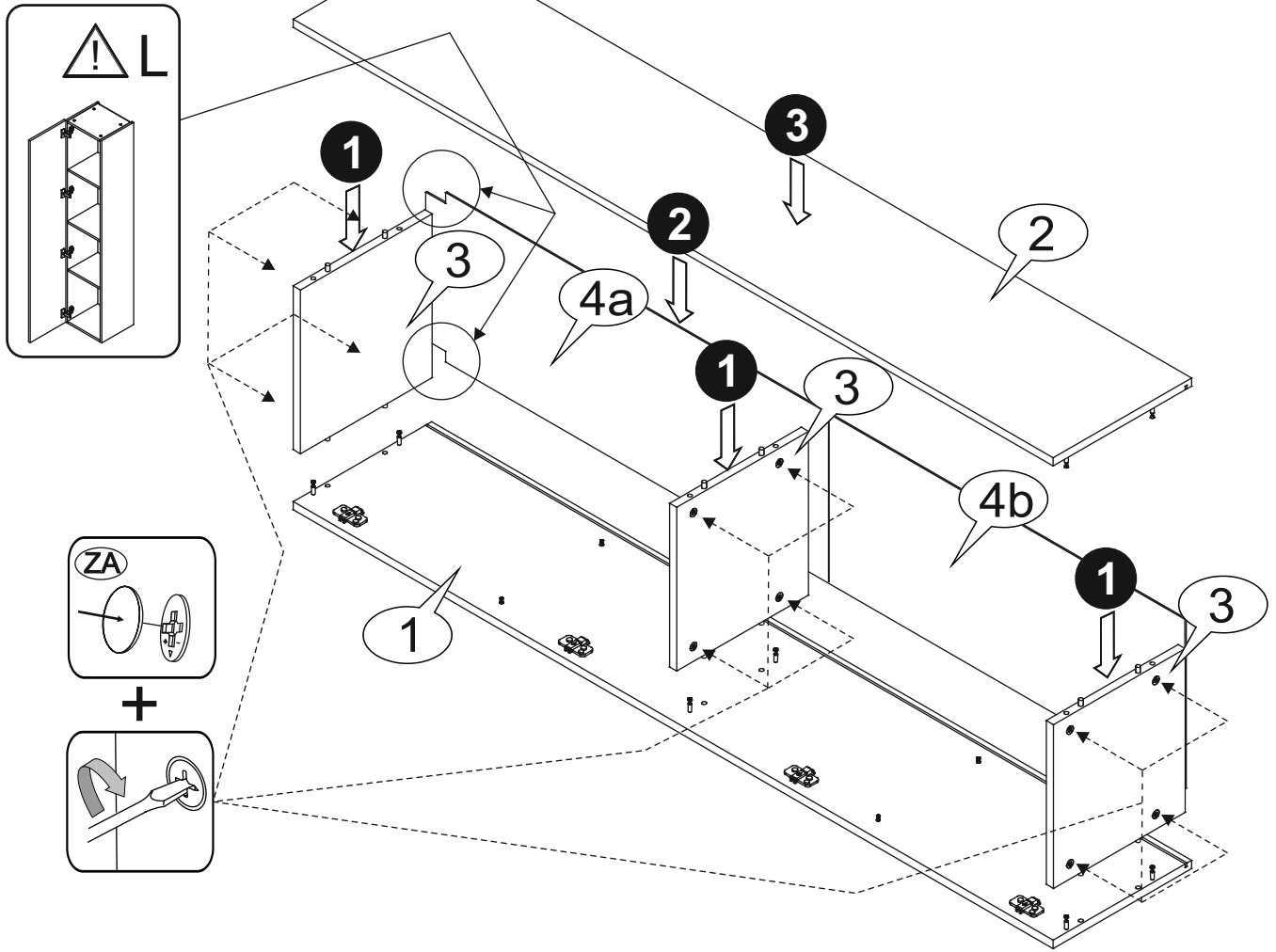

3

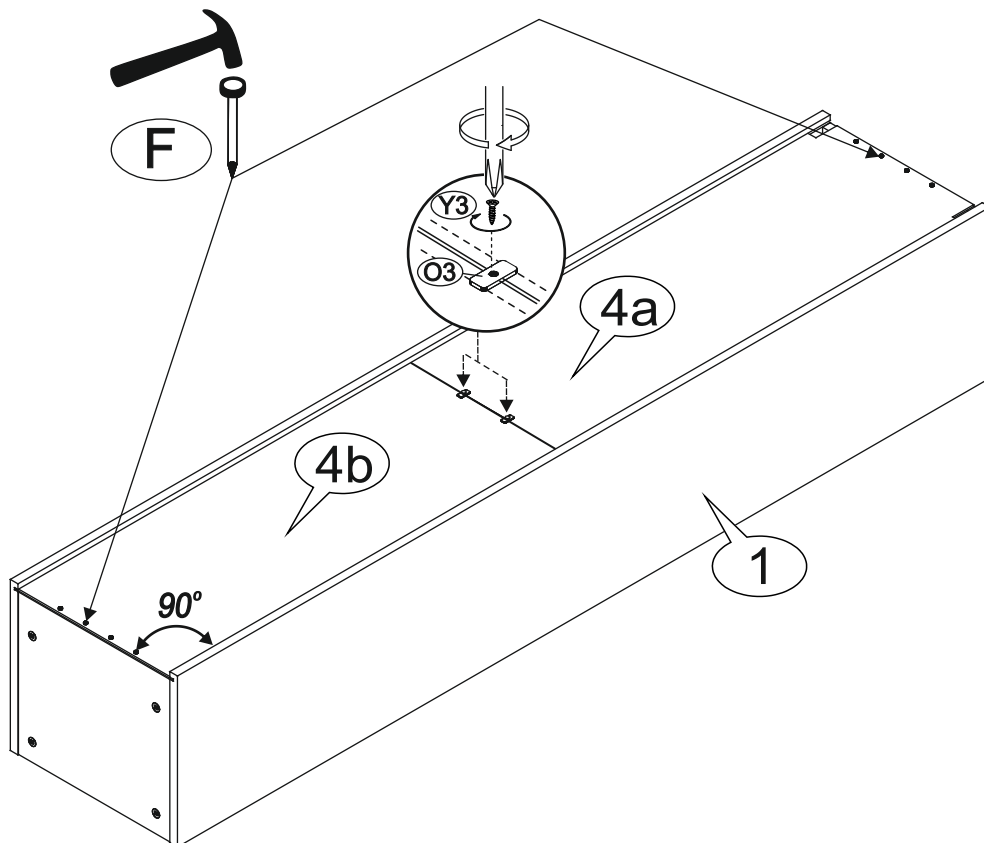

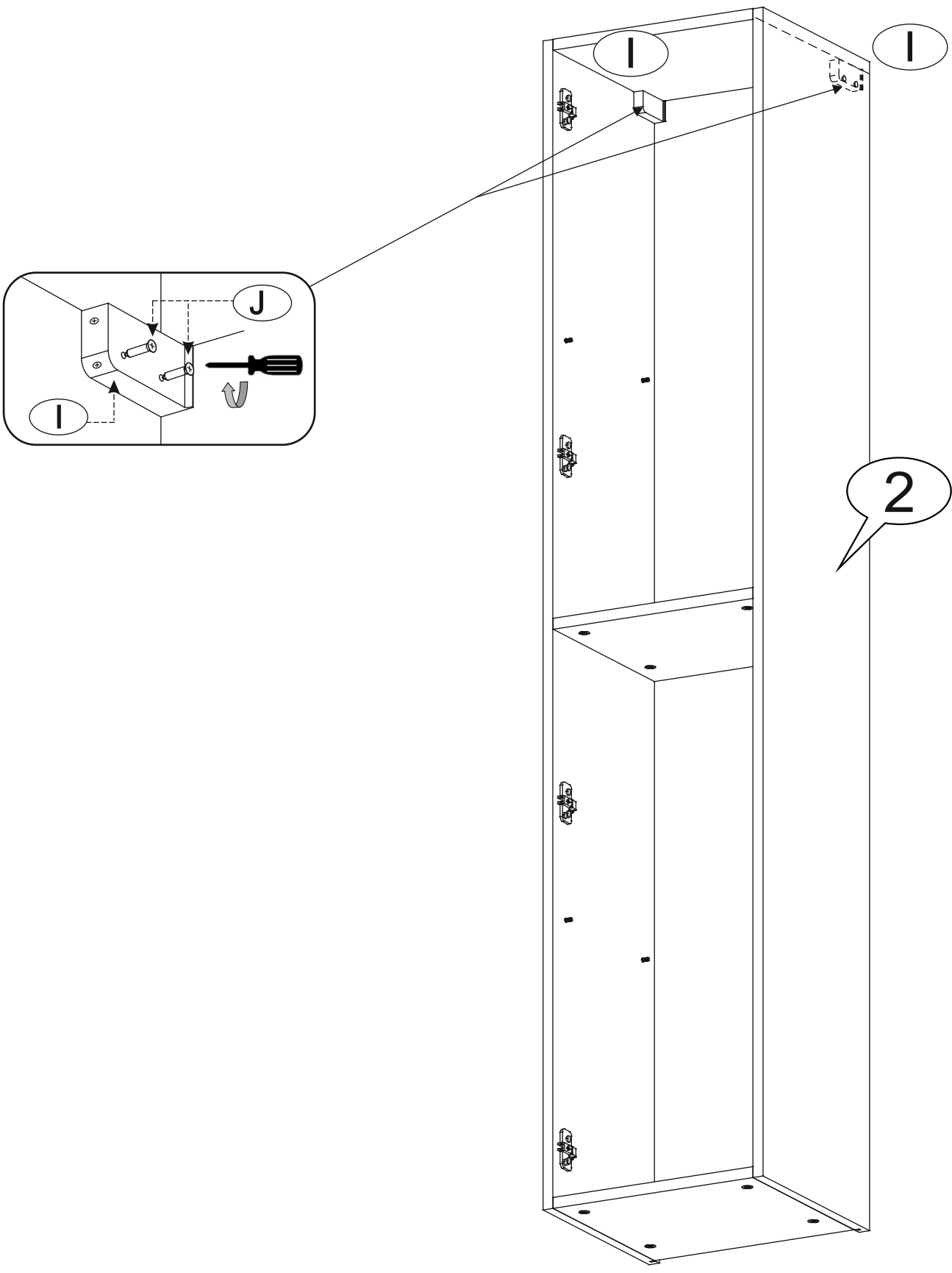

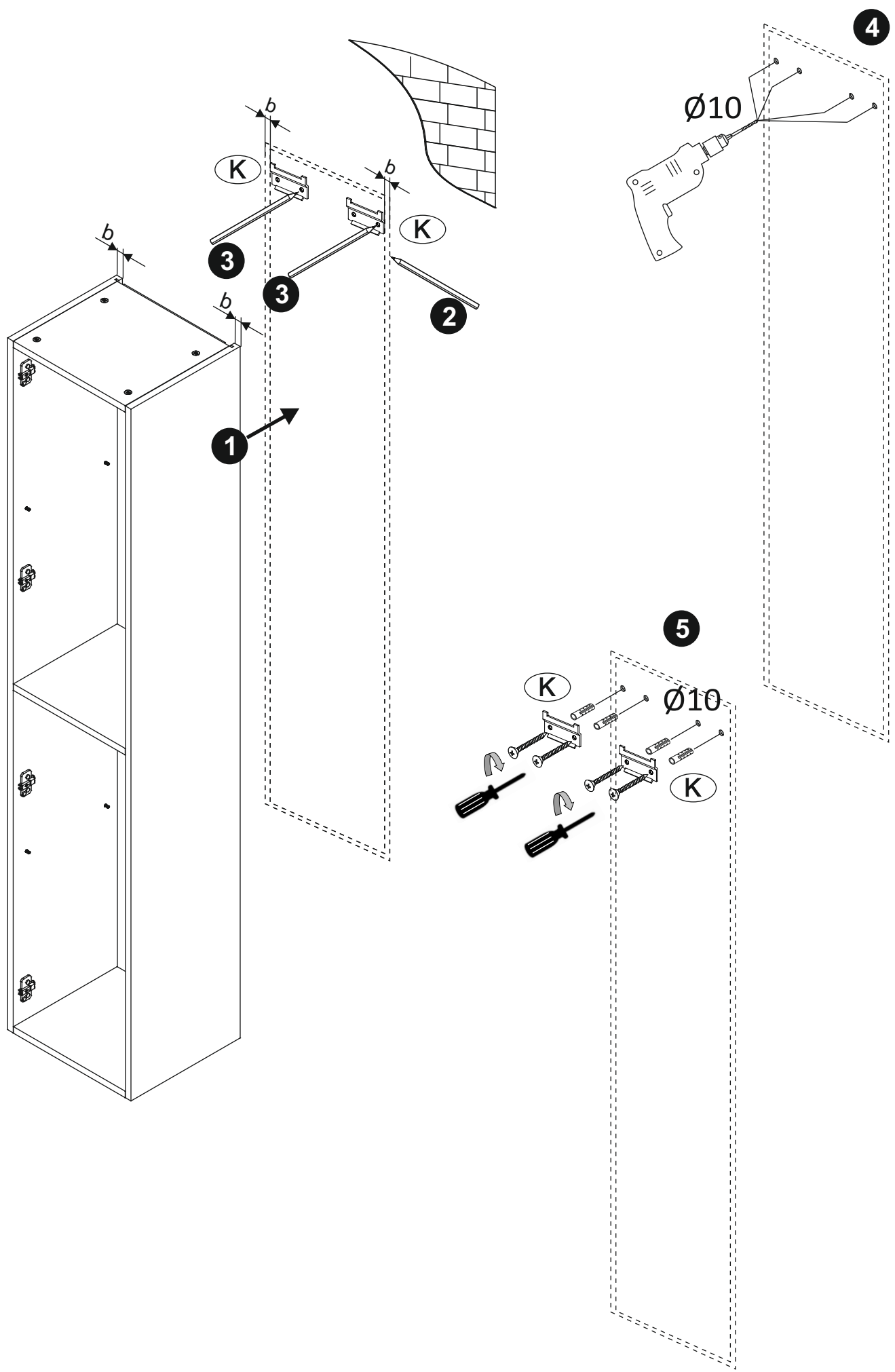

6

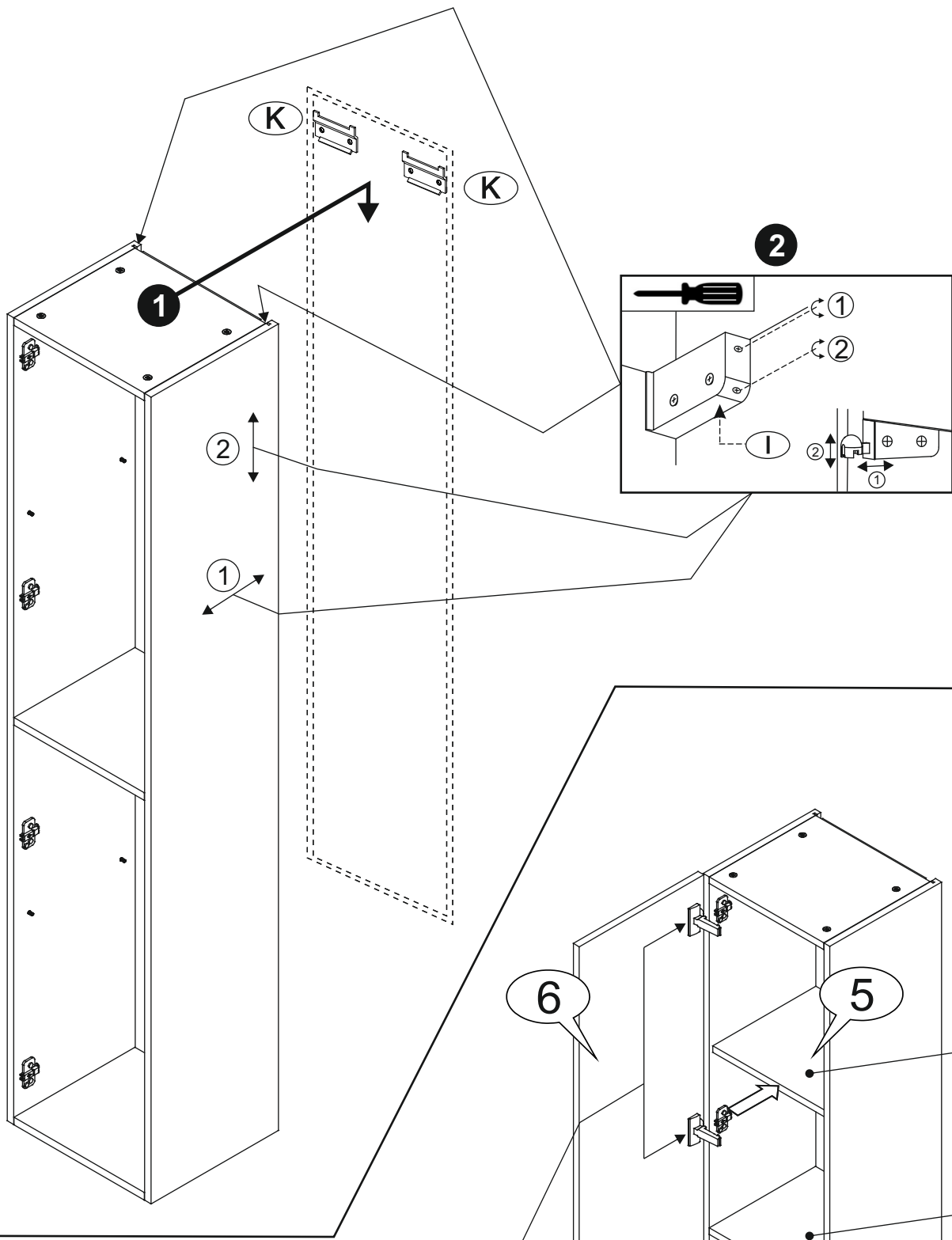

7

