

VITORINO

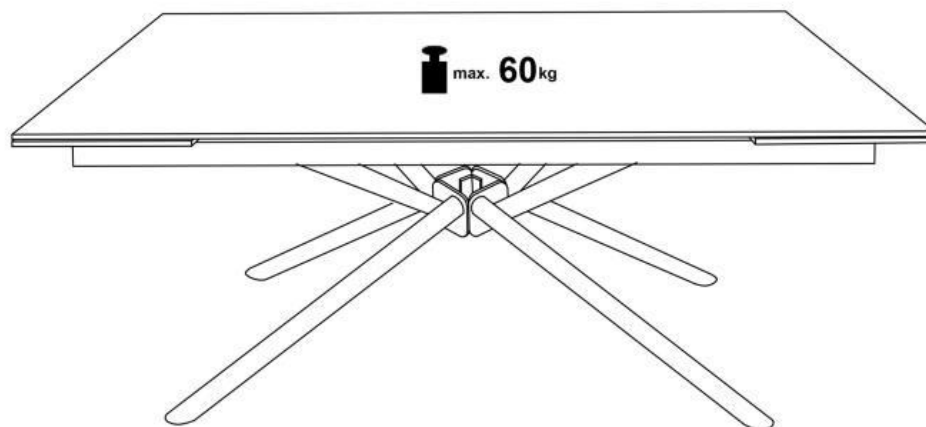

A X1

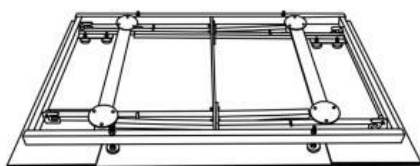

A1 X1

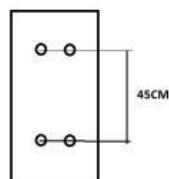

A2 X1

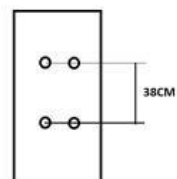

B(1) X1

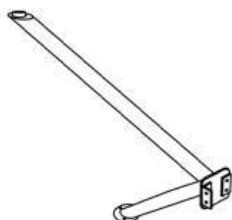

C(2) X1

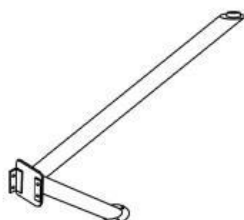

D(3) X1

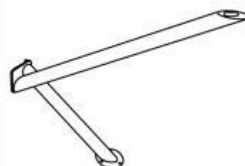

E(4) X1



F X20



M8*13

G X20



$\Phi 8 * \Phi 18 * 1.5$

H X20



M8

X1



1/2

