

LAMINO S-1 SZAFKA 2D

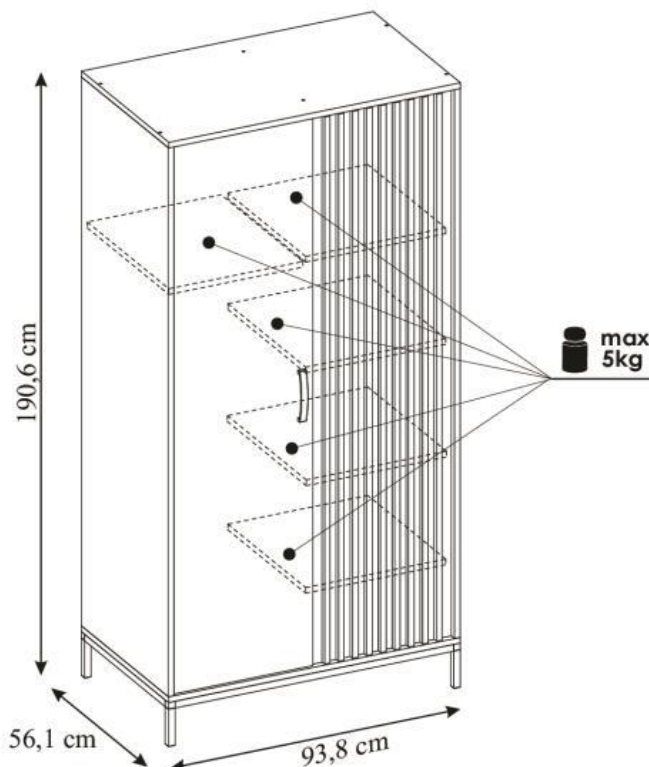

60 min.

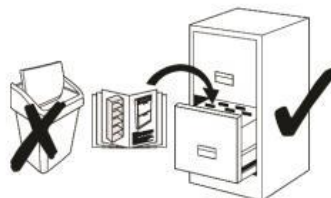

HALMAR Sp.z.o.o
 ul. Centralnego Okręgu Przemysłowego 2
 37-450 Stalowa Wola Polska / Poland
 tel. +48 15 843 28 10, fax: +48 15 842 19 57
 e-mail: office@halmar.com.pl



Uwaga

- ZASADY UŻYTKOWANIA:**
 Maksymalne obciążenie ławy wynosi 40 kg. Na ławie nie wolno stawiać ciężkich przedmiotów. Ławy nie należy pozostawiać w miejscu o dużej wilgotności powietrza. Wyrób należy użytkować zgodnie z jego przeznaczeniem.
- KONSERWACJA:**
 Do czyszczenia zabrudzonego pokrycia tapicerskiego należy używać środków czyszczących przewidzianych do mebli tapicerowanych. Części z tworzyw sztucznych należy czyścić przy pomocy ogólnie dostępnych, przeznaczonych do tworzyw sztucznych, nie rysujących środków czystości. Demontaż jakichkolwiek elementów ławy może spowodować utratę stabilności. Naprawa ławy lub wymiana podszepsołów może być dokonana jedynie przez przeszkolony personel.
- REKOMIENDA I GWARANCJA:**
 Firma Halmar Sp. z o.o. udziela na produkt gwarancji w postaci 12-miesięcznej rękojmi.

Attention

- TERMS OF USE:**
 The maximum load of the table is 60 kg. Do not place heavy objects on the table. Table should not be left in a place with high humidity. The product should be used in accordance with its intended purpose.
- MAINTENANCE:**
 For cleaning dirty upholstery covering use cleaners intended for upholstered furniture. Plastic parts should be cleaned with a commercially available, non-abrasive cleaning agents intended for plastic surfaces. Disassembling any of the table element may result in loss of stability of the table. Repair or replacement of table components can only be done by trained personnel.
- WARRANTY AND GUARANTEE:**
 Company Halmar L.L.C. provides a product guarantee in the form of a 12-month warranty.

2024.04.08

1/11

NOWOŚĆ

LAMINO S-1 SZAFKA 2D

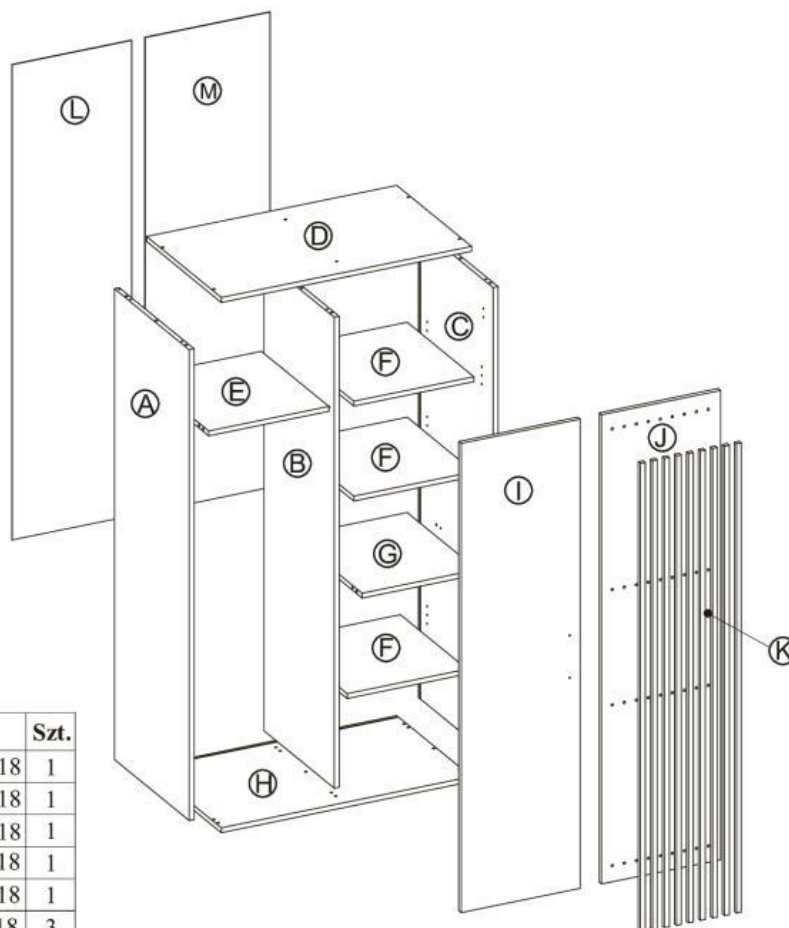

	Kod	Wymiar	Szt.
Ⓐ	LA30-01	1730x560x18	1
Ⓑ	LA30-02	1730x526x18	1
Ⓒ	LA30-03	1730x560x18	1
Ⓓ	LA30-04	938x561x18	1
Ⓔ	LA30-05	431x525x18	1
Ⓕ	LA30-06	450x500x18	3
Ⓖ	LA30-07	451x506x18	1
Ⓗ	LA30-08	938x561x18	1
Ⓘ	LA30-09	1724x446x18	1
Ⓙ	LA30-10	1724x446x18	1
Ⓚ	LA30-11	1724x16x18	9
Ⓛ	LA30-12	1746x448x3	1
Ⓜ	LA30-13	1746x468x3	1



























UWAGA

Instrukcja montażu nie jest dokumentacją techniczną, producent zastrzega sobie możliwość zmian konstrukcyjnych.

Przed przystąpieniem do montażu należy sprawdzić zawartość paczek pod względem ilości i jakości z instrukcją montażu.

NIE WOLNO montować uszkodzonych elementów mebli, ewentualne ich wady należy zgłosić przed montażem w przeciwnym razie nie będą one podlegać reklamacji.

LAMINO S-1 SZAFKA 2D

(N) x26  ø 8x30	(O) x36  ø 8x18	(P) x8 	(Q) x8 
(R) x8 	(S) x8  ø 20	(T) x8 	(U) x12  ø 7x50
(V) x1 	(W) x2  ø 4x25	(X) x1 	(Y) x27  ø 3,5x16
(Z) x16  ø 3x20	(A1) x4  ø 4x30	(B1) x14  ø 4x40	(C1) x4 
(D1) x2  509mm	(E1) x1  886m	(F1) x2 	
(G1) x20 	(H1) x4 	(I1) x1 	(J1) x1 
(K1) x1  429mm	(L1) x1 	(M1) x10 	(N1) x12 

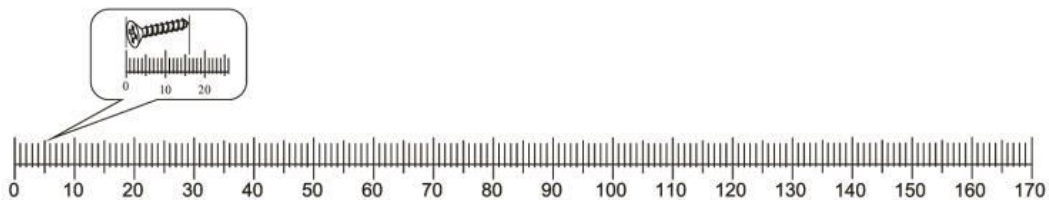

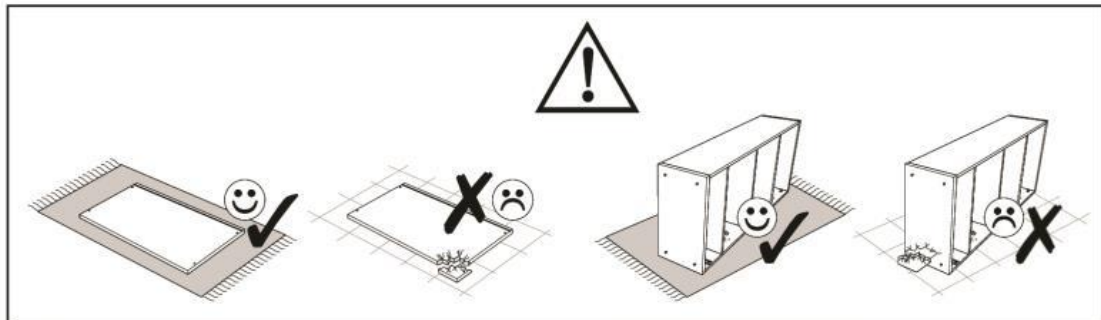

1



Zwróć szczególną uwagę na prawidłowy otwór podczas wbijania kołków

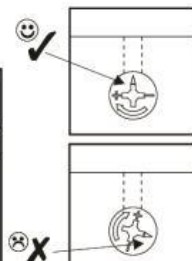
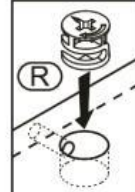
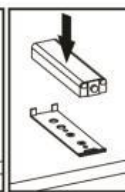
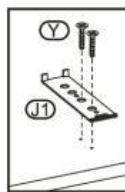
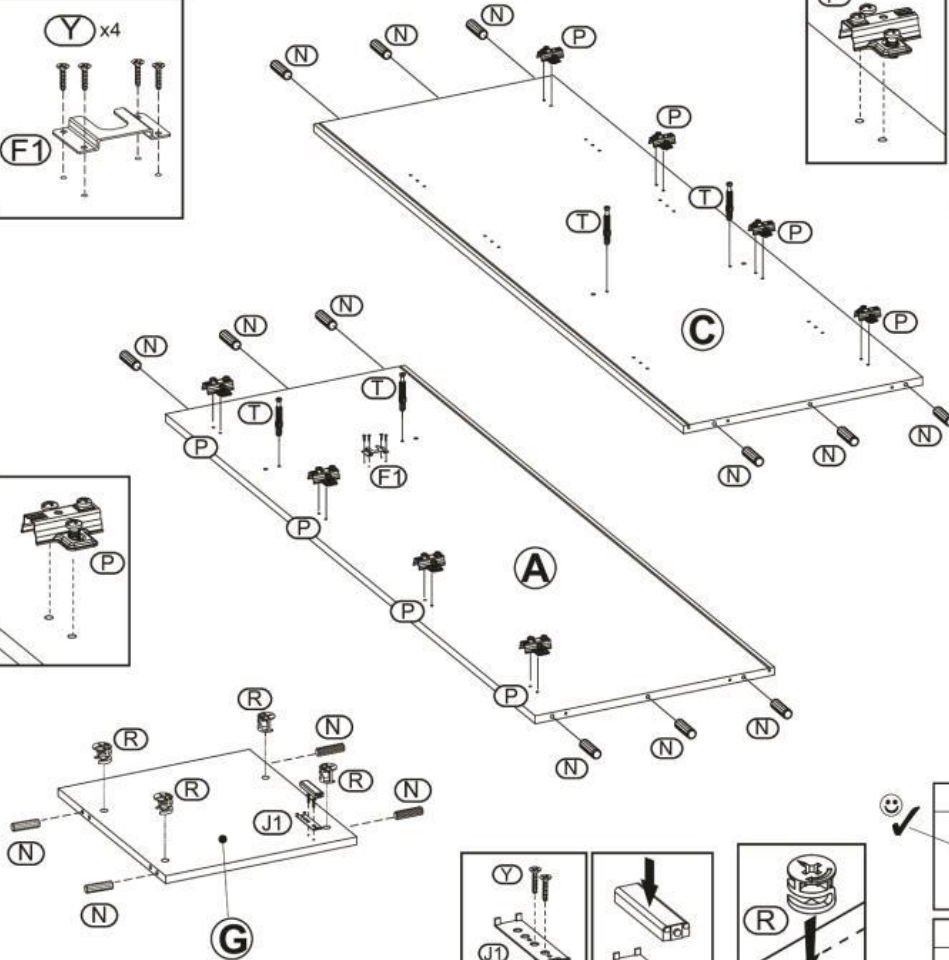
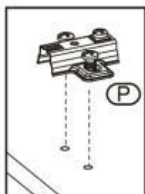
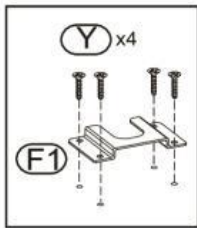
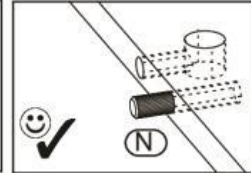
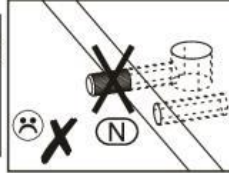
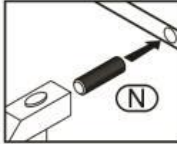
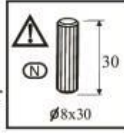

2

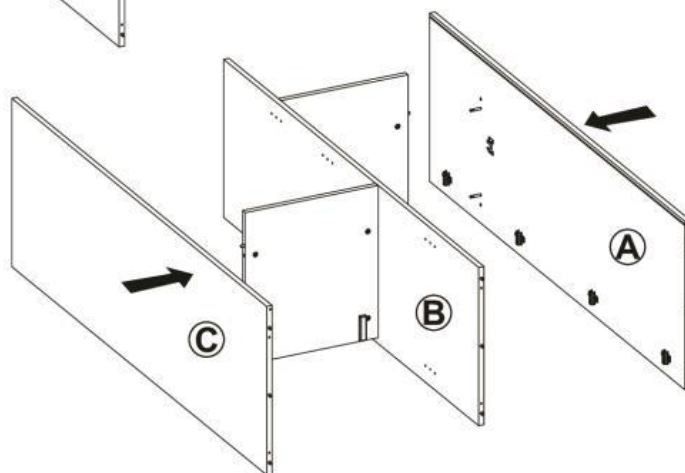
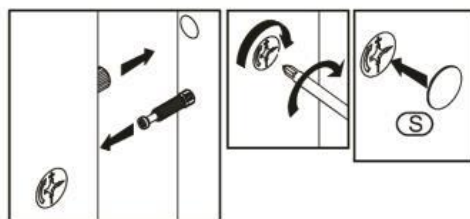
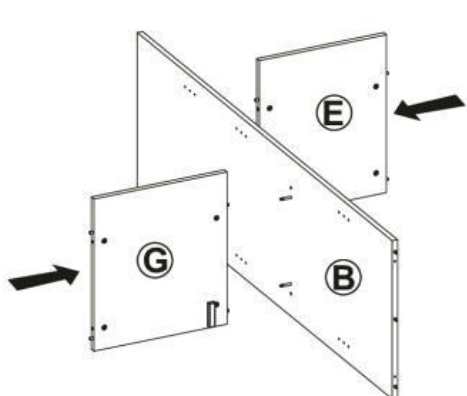
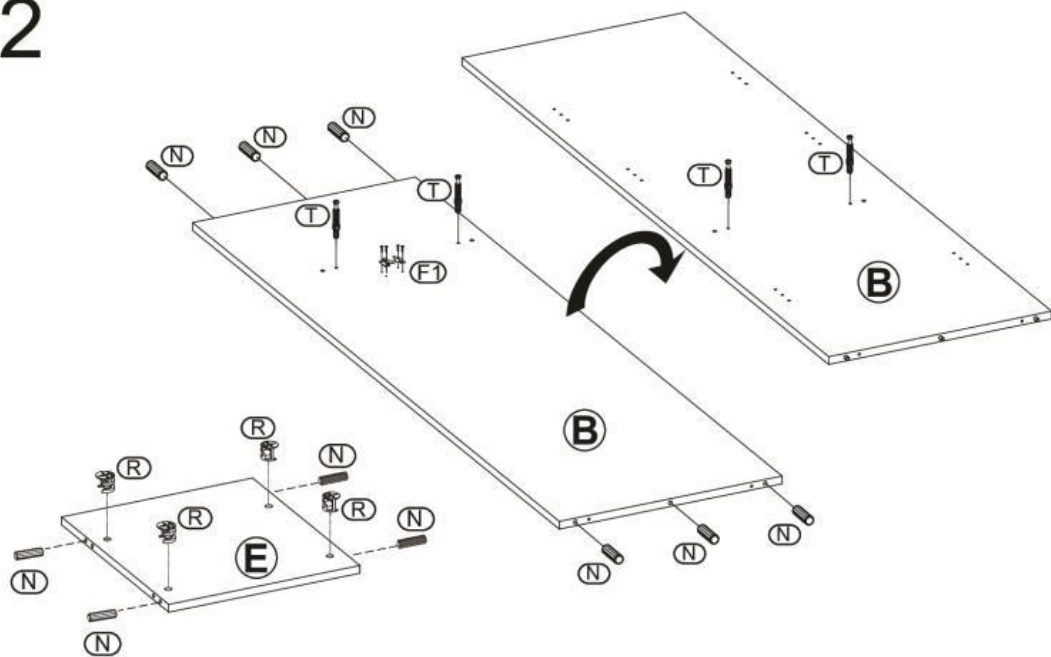

3

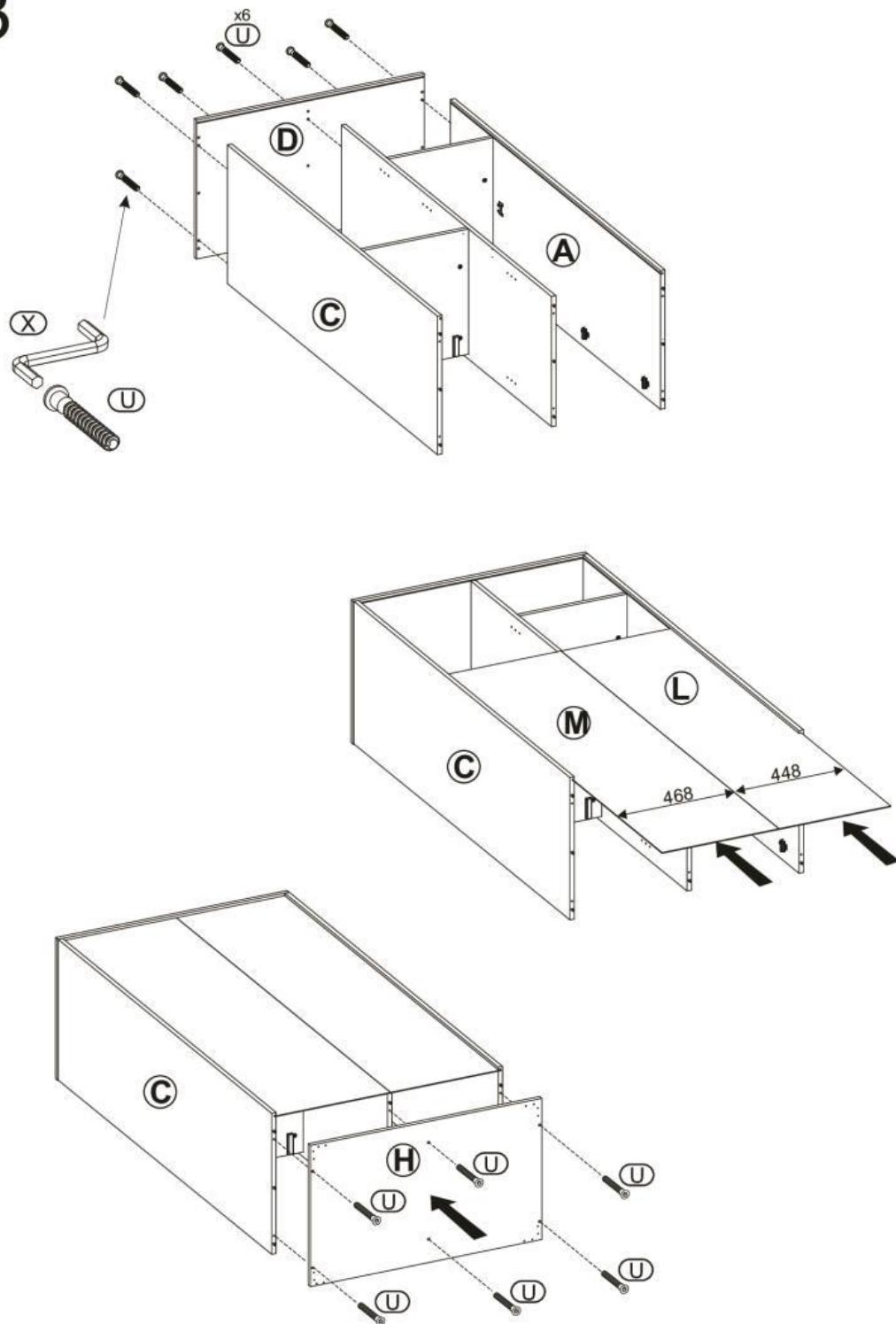

4

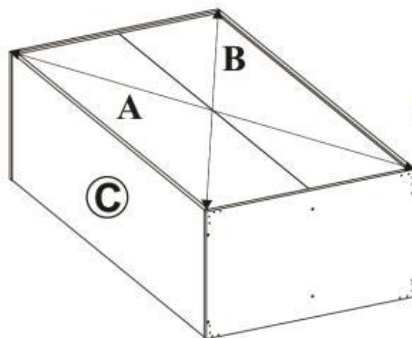

UWAGA !!!

A=B



Uwaga !!!

Przed zamocowaniem ściany tylnej należy zmierzyć przekątne szafki. Jeżeli wymiary są jednakowe to możemy przystąpić do zamocowania jej, jeżeli nie to musimy do tego doprowadzić ściskając przeciwległe rogi szafki, tam gdzie wymiar był większy.

Nieprawidłowe ustawienie przekątnych przed montażem ściany tylnej uniemożliwi prawidłowe późniejsze wyregulowanie frontów.

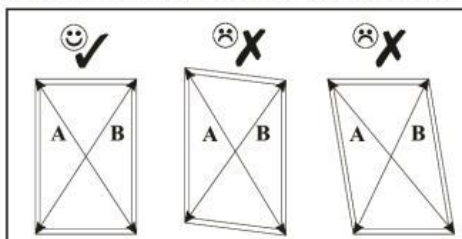

5

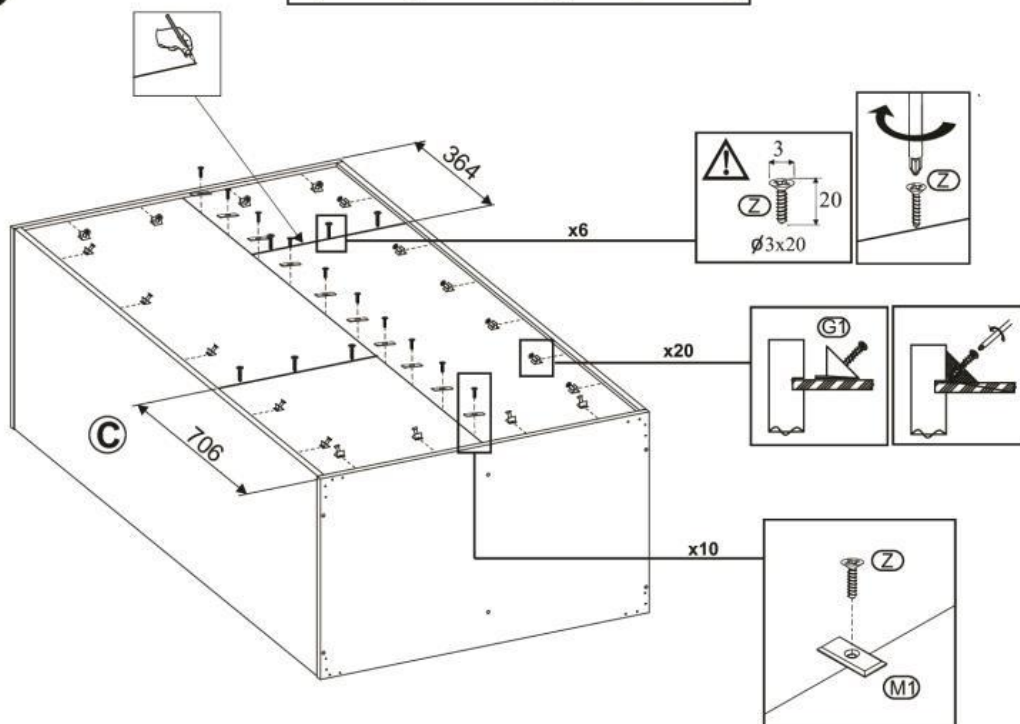

6

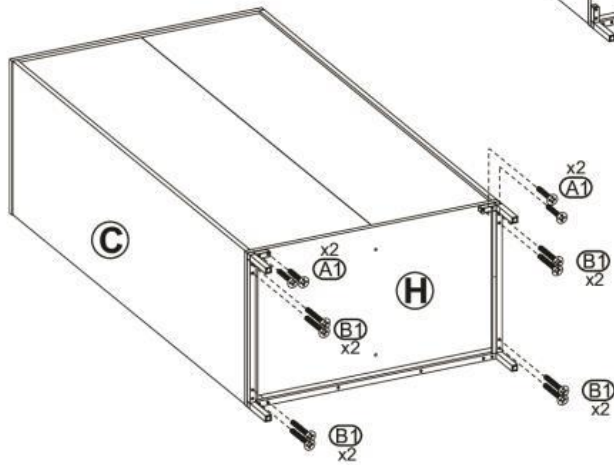
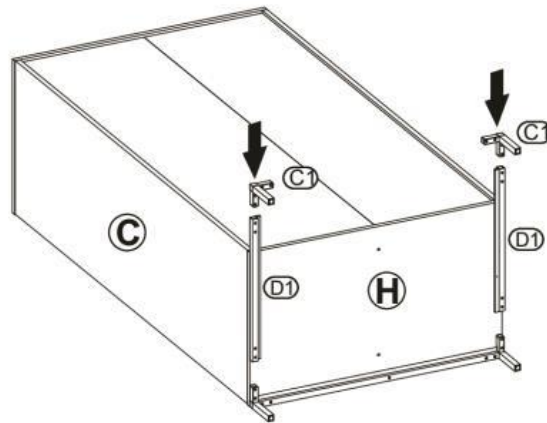
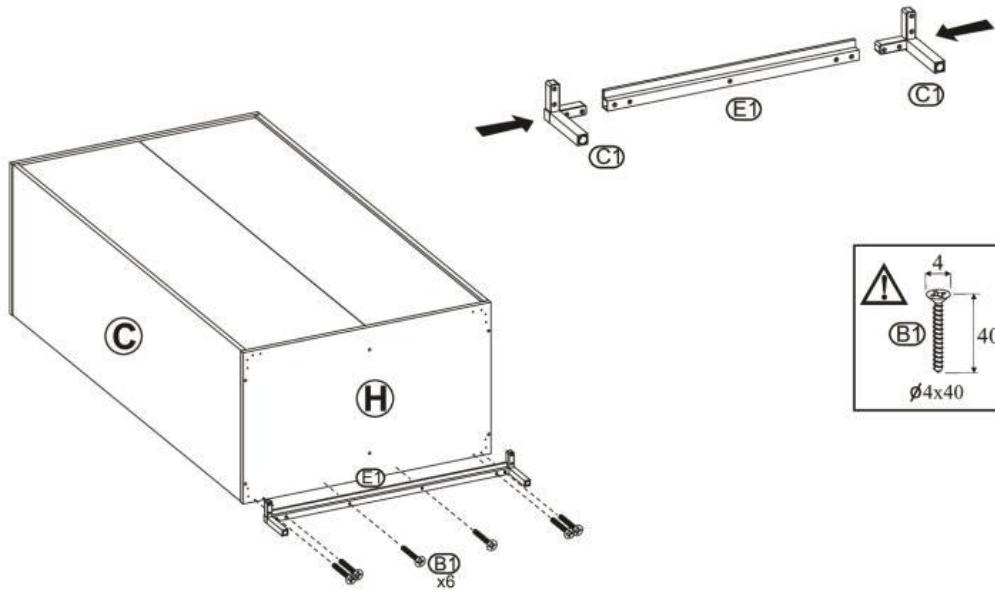

!!!

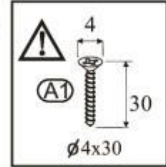
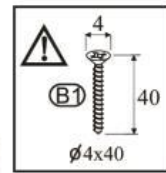

7

**UWAGA !!!**

Mebel należy trwale zamocować do ściany, aby uniknąć ryzyka związanego z przewróceniem się mebla. W paczce nie ma śrub mocujących, ponieważ rodzaj mocowania należy odpowiednio dobrać do rodzaju ściany. Dobierz właściwe do twojego rodzaju ściany.

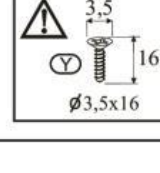
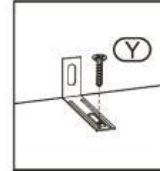
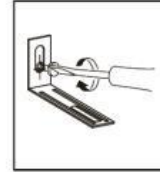
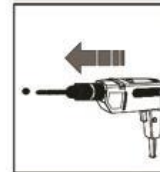
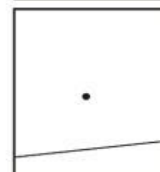
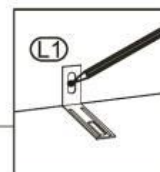
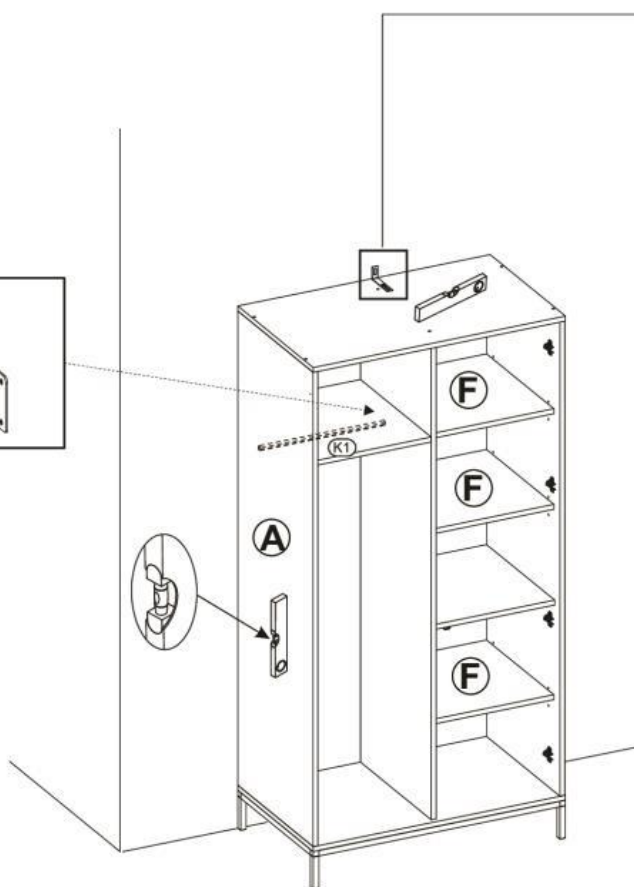
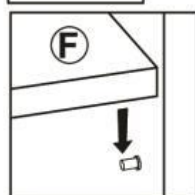
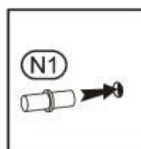
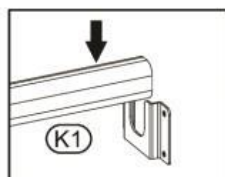
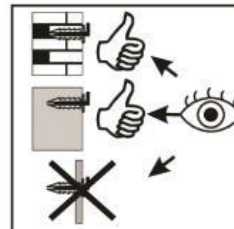

8

W otwory znajdujące się na listwie i drzwiach zaaplikuj klej.

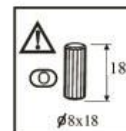
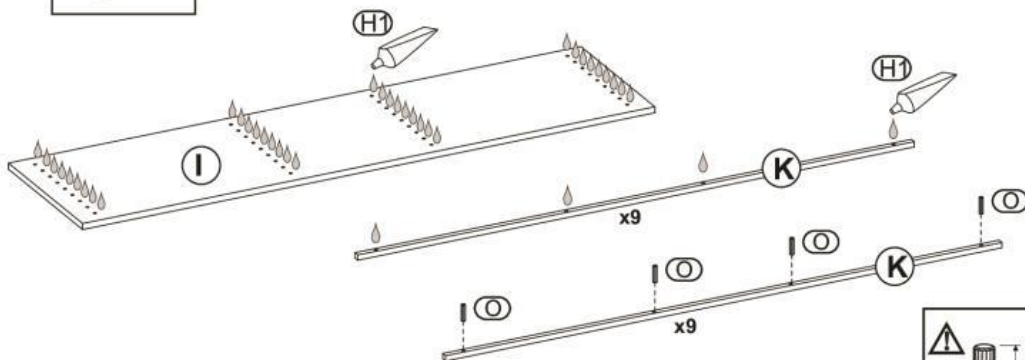
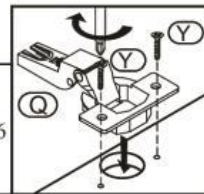
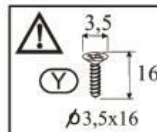
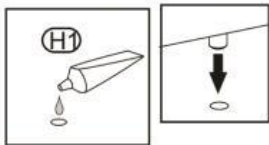

9

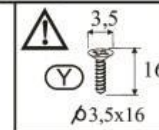
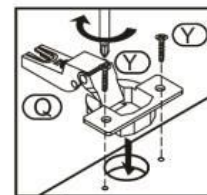
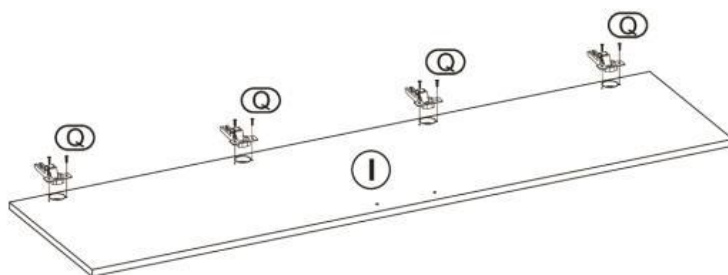

10

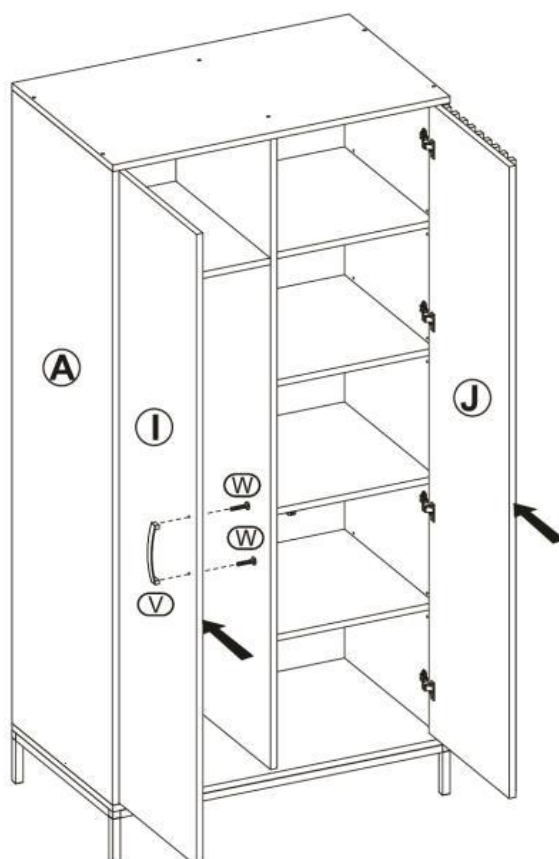
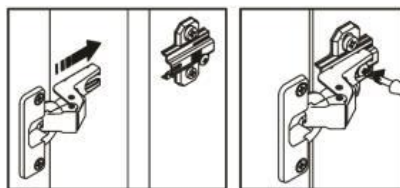

Uwaga !!!

Wykonaj końcową regulację frontów.

