

A	B	C	D	
1	S463-0023	496	200	2/3
2	S463-0026	496	200	2/3
3	S463-0027	1442	396	1/3
4	S463-1035	1450	383	1/3
5	S463-1036	1450	383	1/3
6	S463-1037	1450	363	1/3
7	S463-2007	900	400	2/3
8	S463-2008	900	400	2/3
9	S463-3009	477	362	2/3
10	S463-3010	376	353	2/3
11	S463-3023	476	353	2/3
12	S463-3024	476	358	2/3
13	S463-5003	475	345	2/3
14	S463-5004	599	471	3/3
15	S463-9013	1460	389	1/3
16	S463-9307	1460	489	1/3

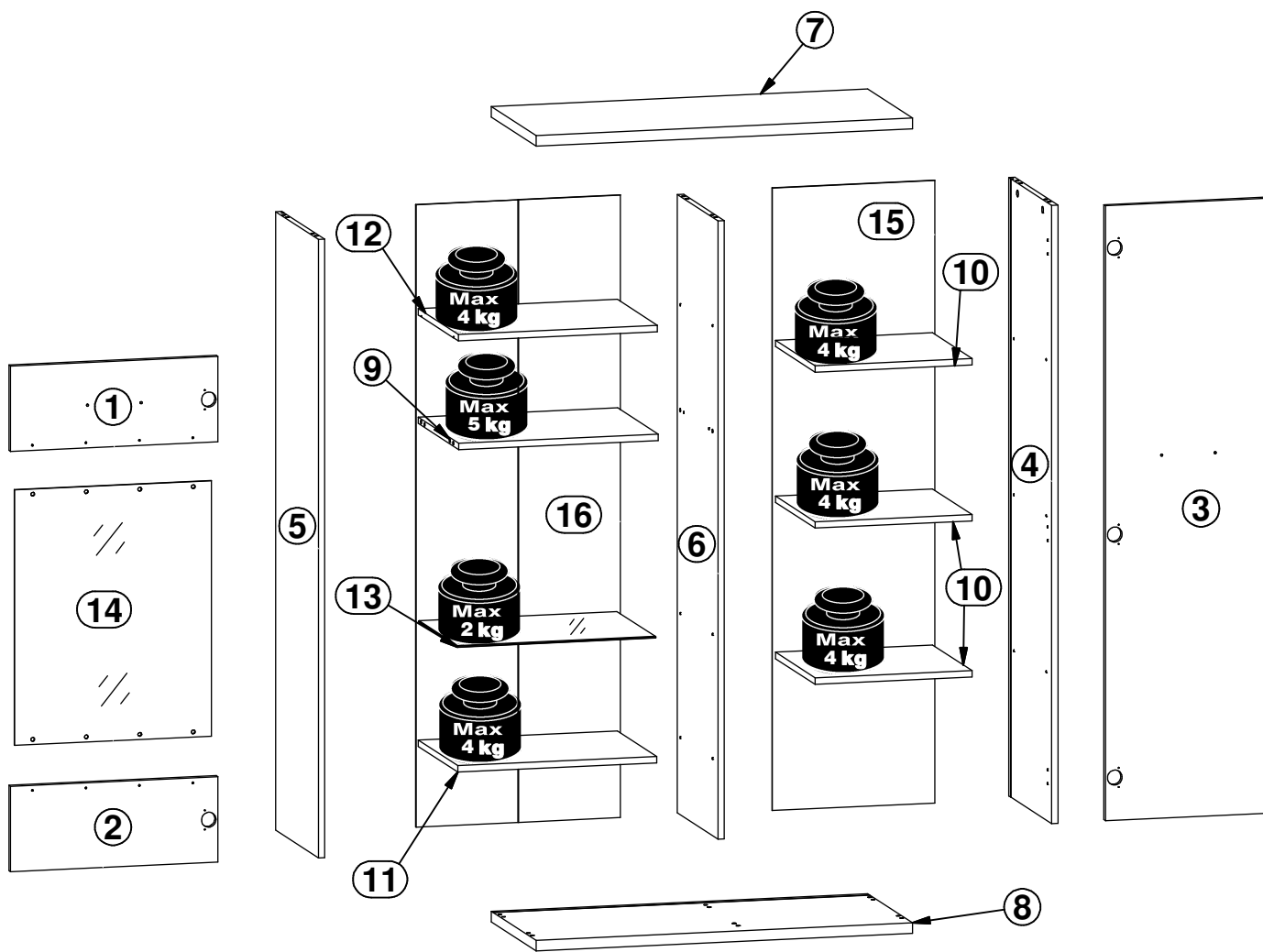

3x Ø35 a204	2x Ø35 a211	5x b90	2x l28 mm c511\1	20x Ø5x17 mm d1	4x Ø5x17 mm d3	8x Ø5x16 mm e47	6x Ø7x60 mm e8	16x Ø8x30 mm f1
5x Ø48x10 mm k43	14x l2	4x l86	1x n26	7x 22x9.5x20.7 mm n108	8x Ø5.3xØ8.3x4.8 mm o54	1x Ø3.5x16 mm p38	10x Ø3.5x15 mm p51	13x Ø2.9x16 mm p55
4x Ø4x22 mm p60	10x Ø15x12 mm #16 r1	10x 20/11 r42	6x Ø20mm s68	1x 4 mm z1				

1

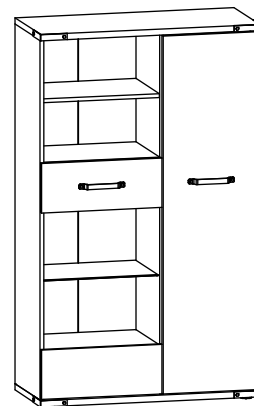
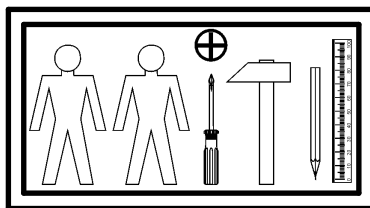
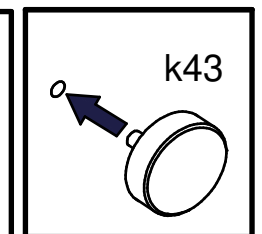
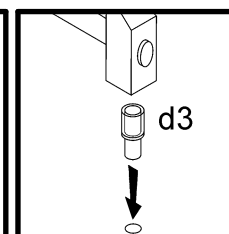
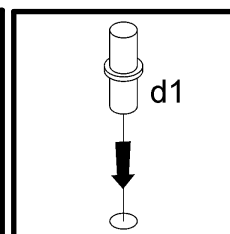
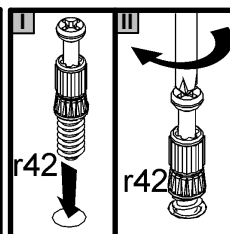
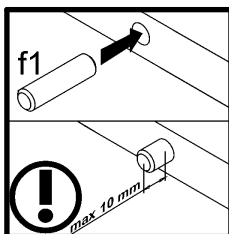
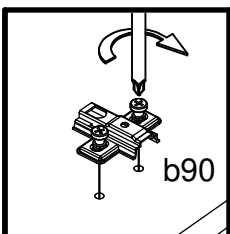
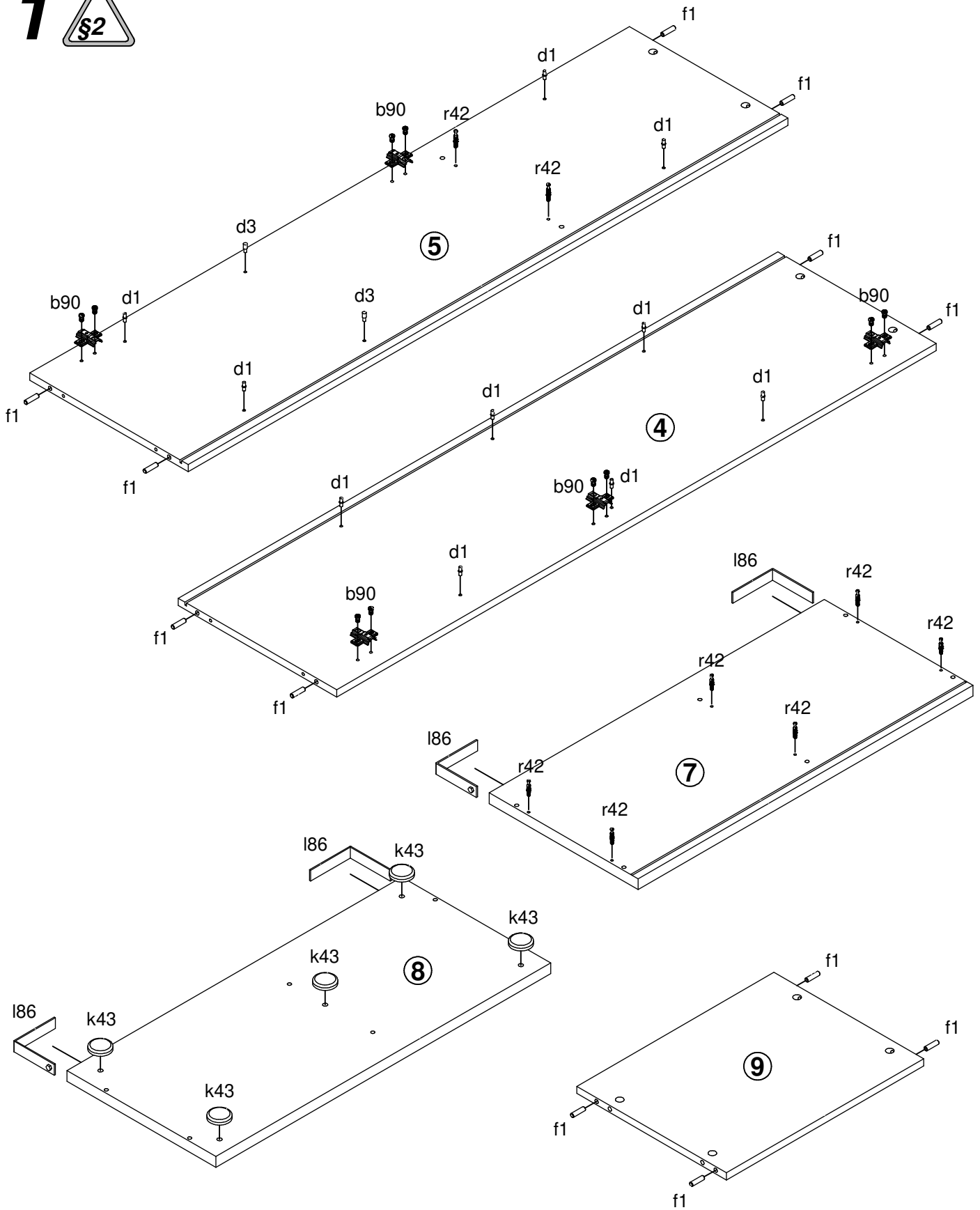

2

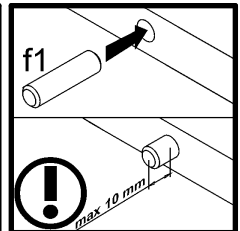
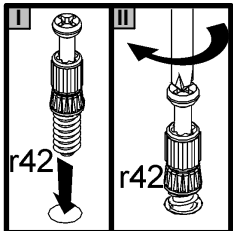
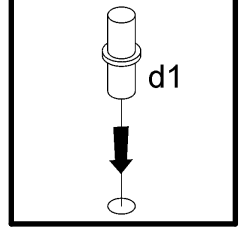
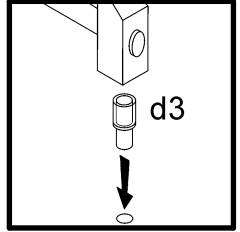
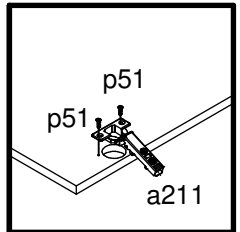
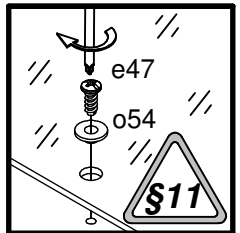
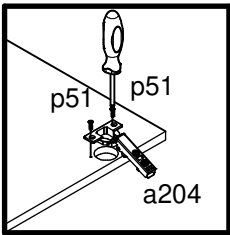
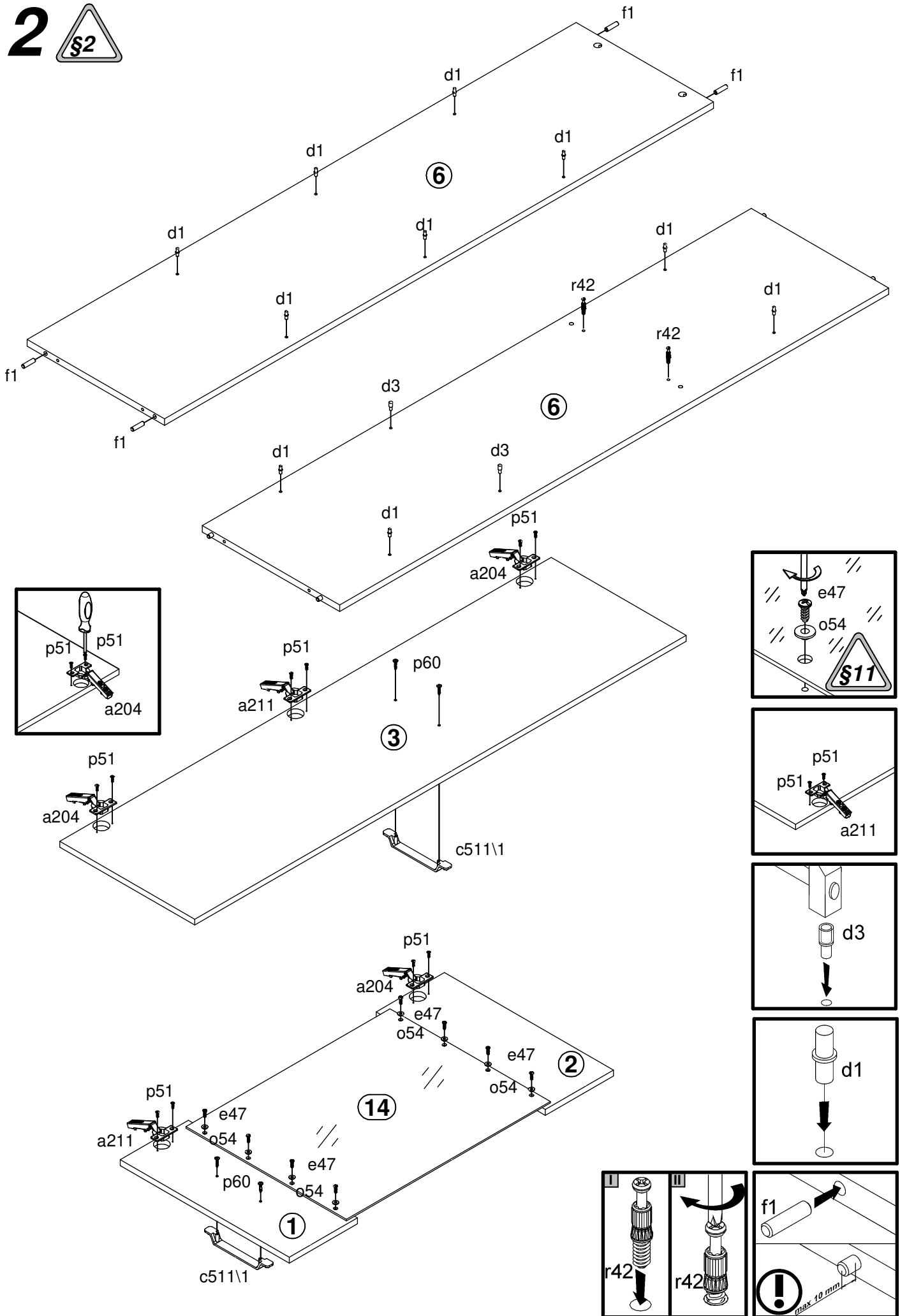

3

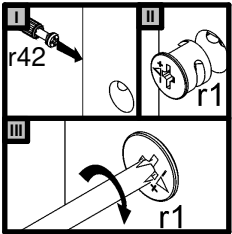
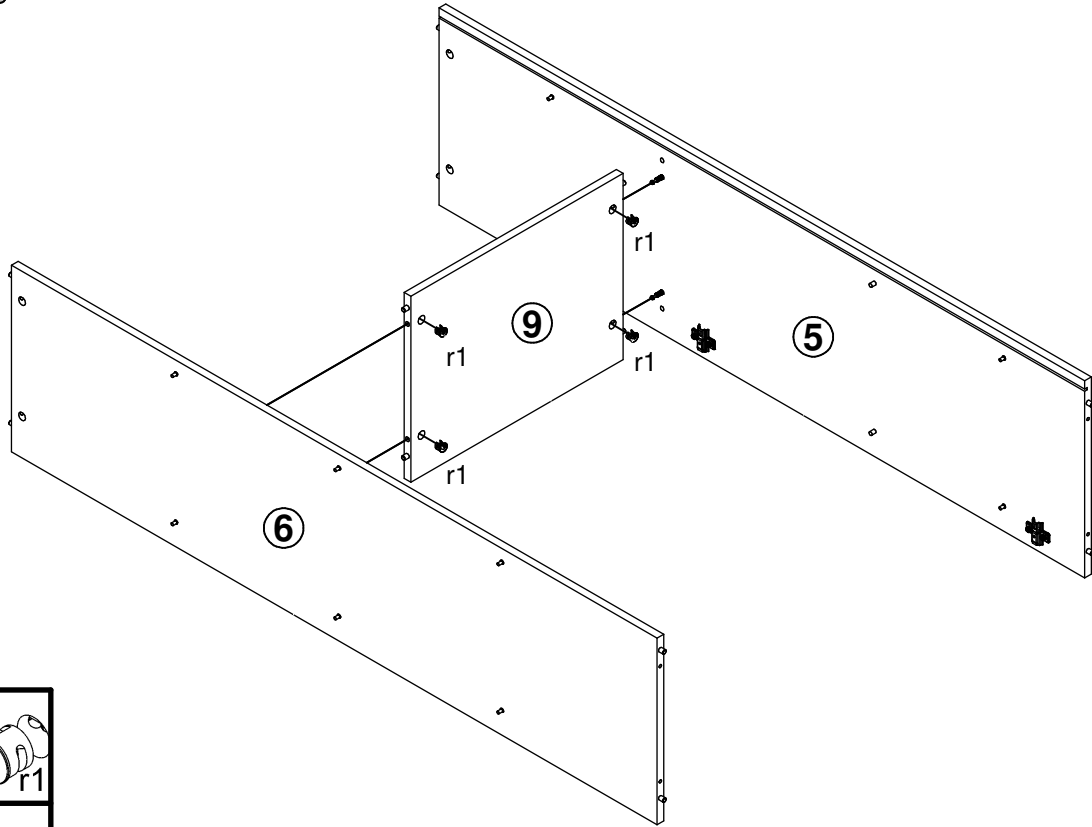

4

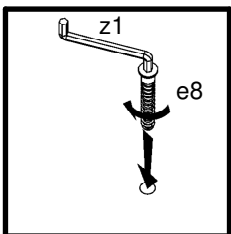
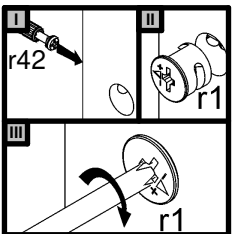
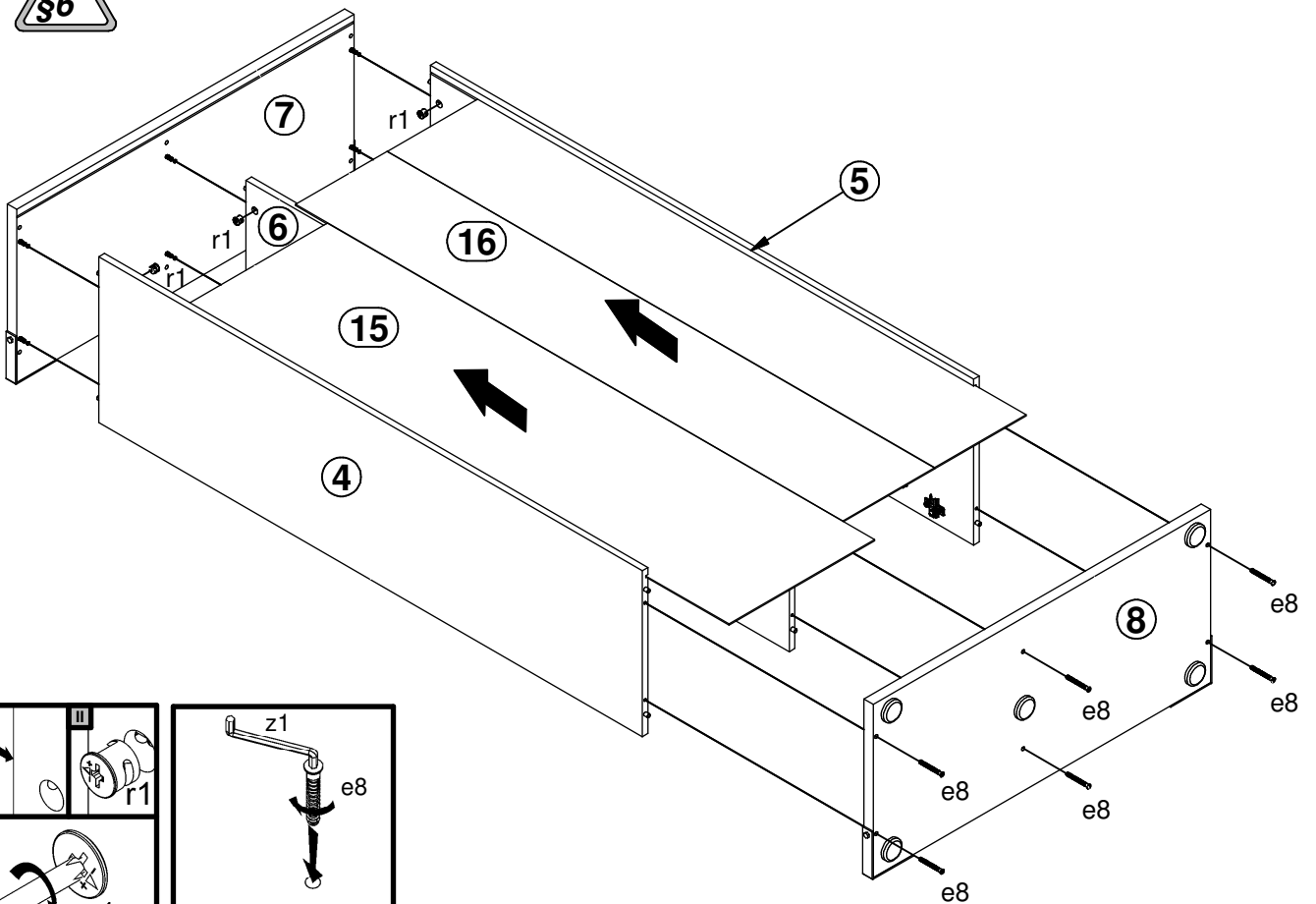

5 

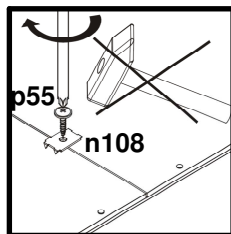
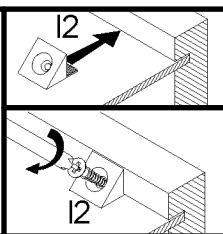
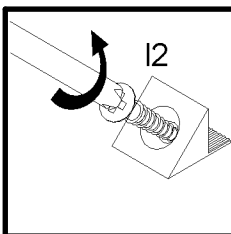
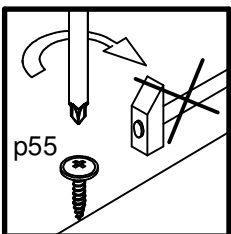
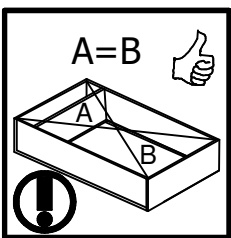
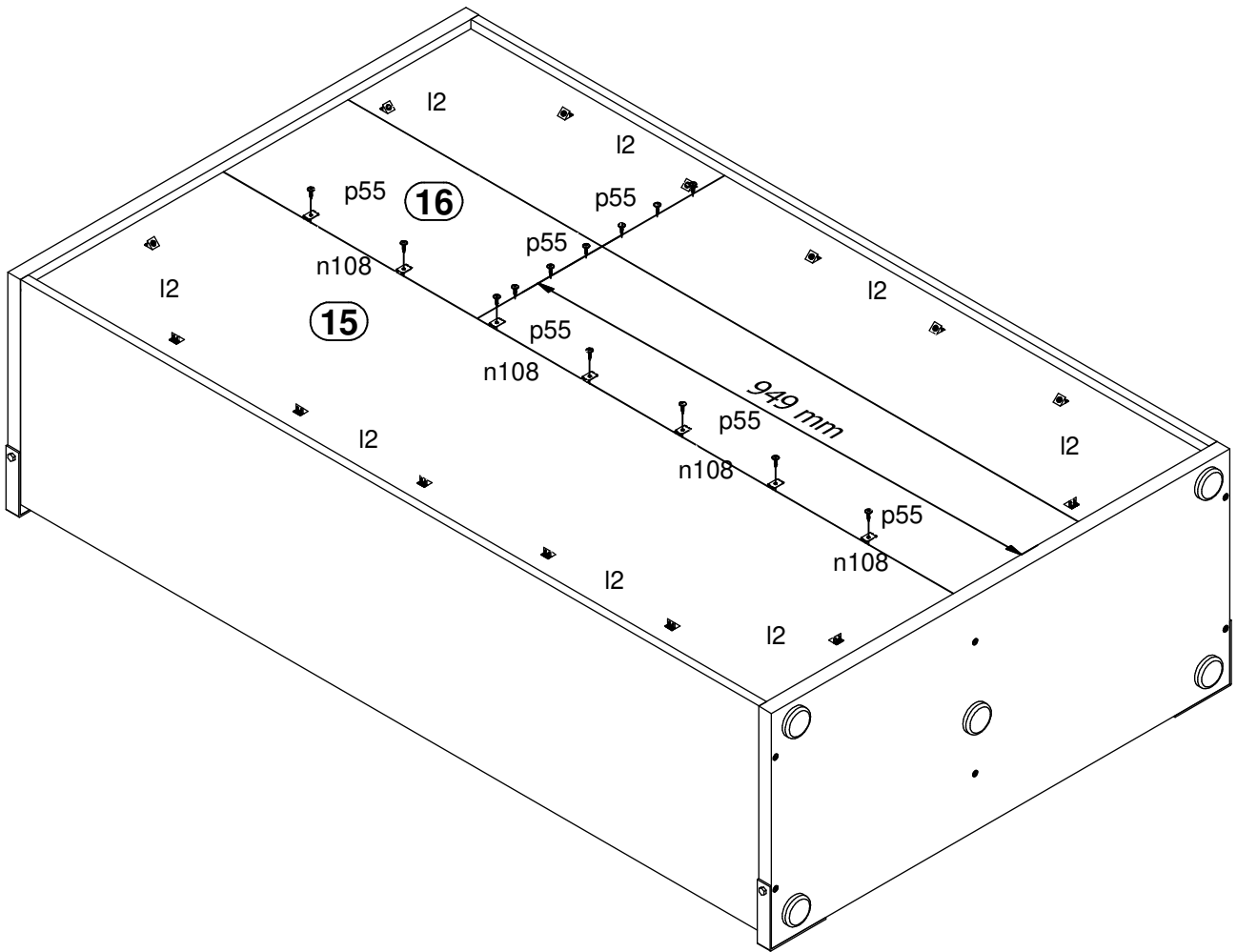

6

