

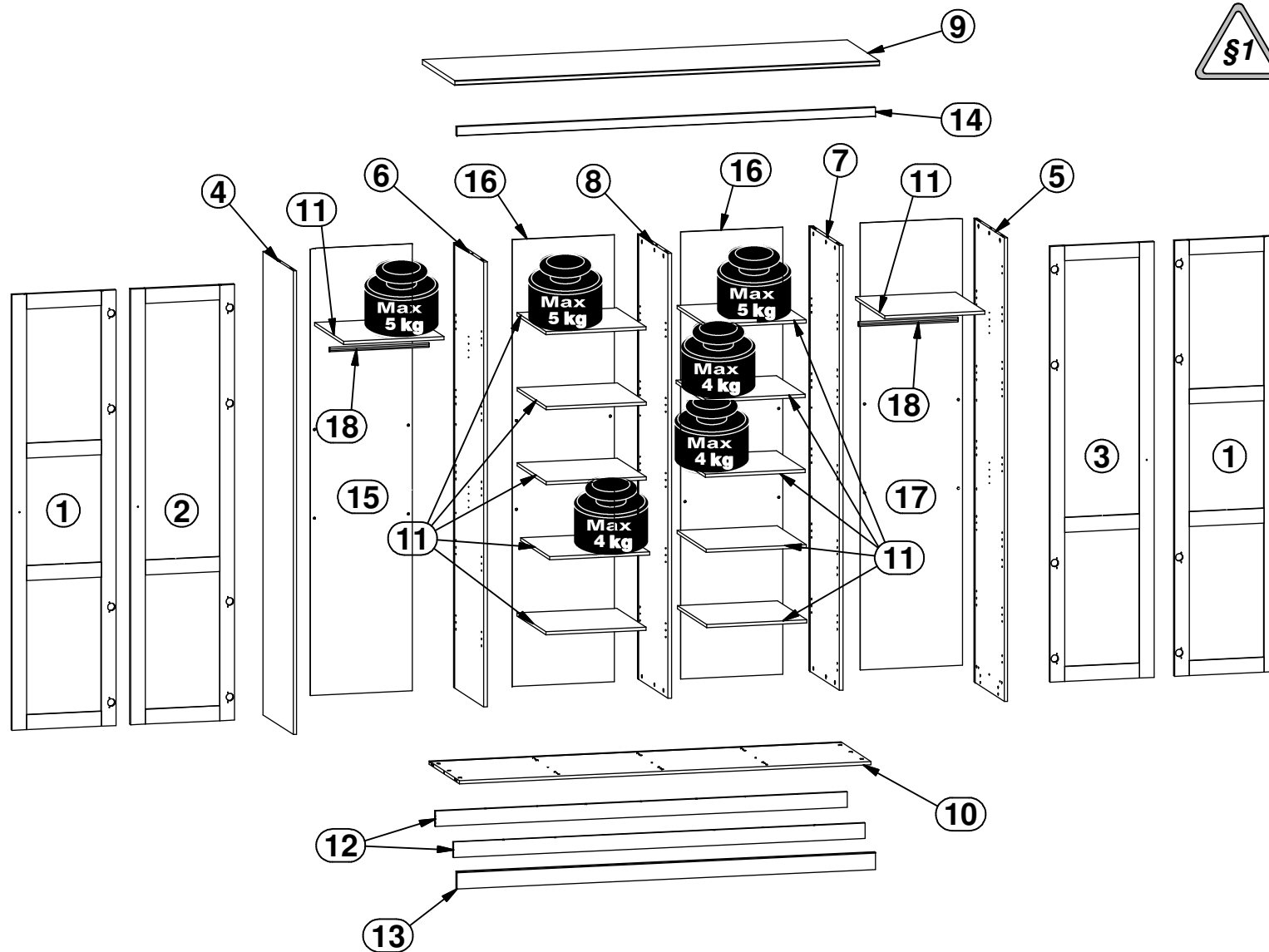

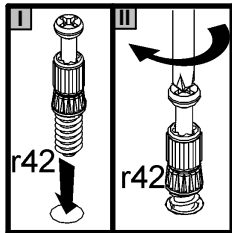

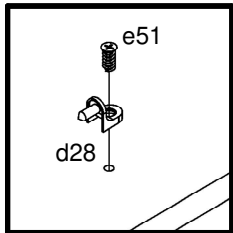

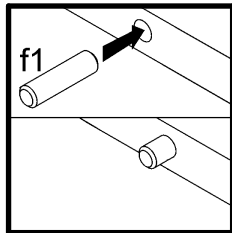

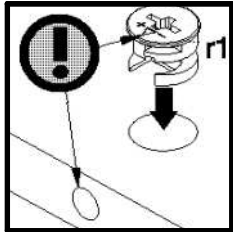
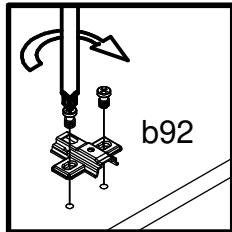
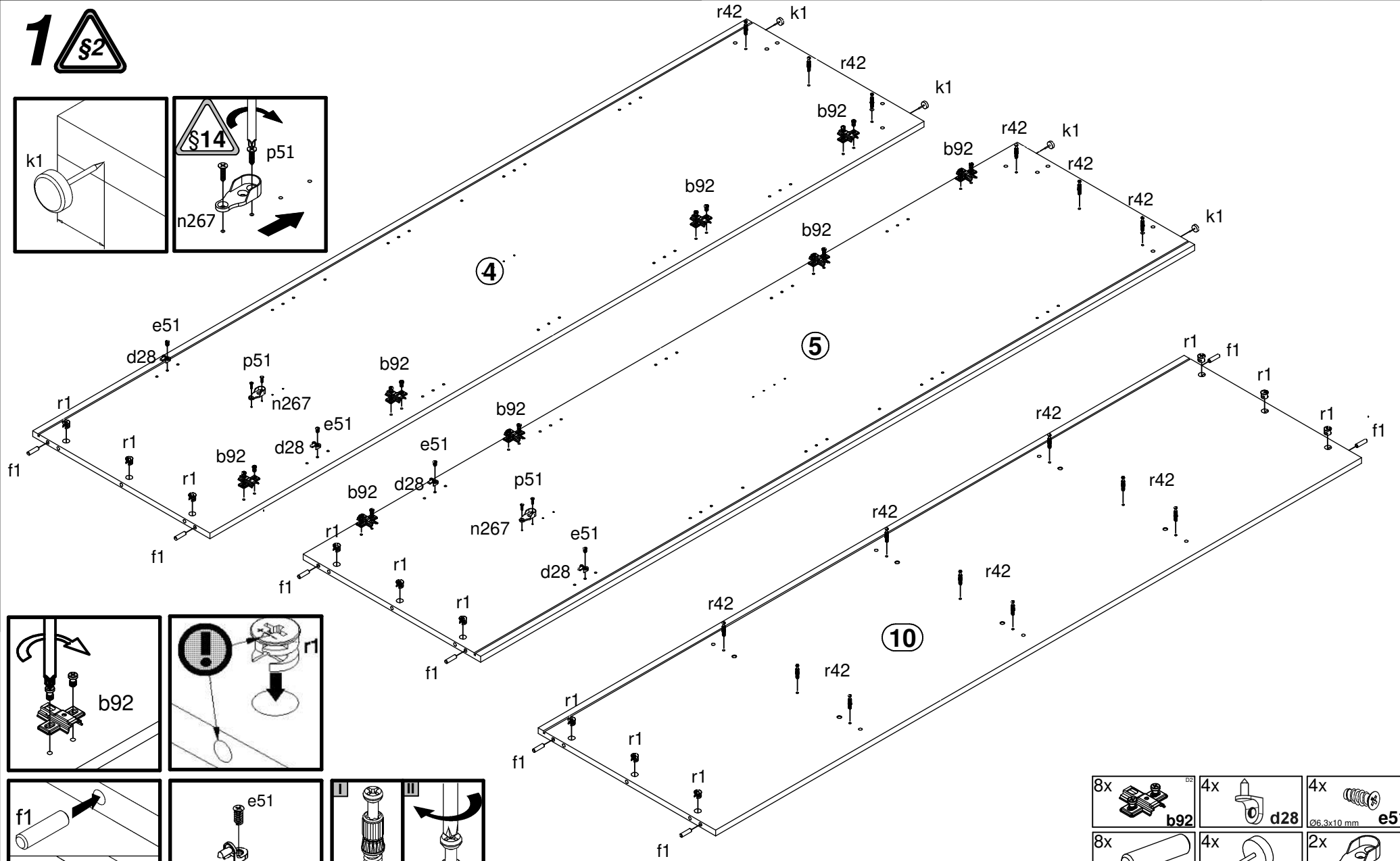
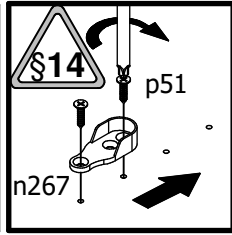
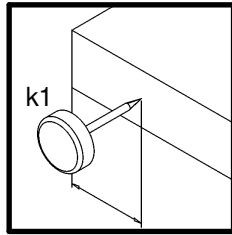

4x hamulec a204	4x hamulec a205	4x hamulec a211	4x hamulec a212	cm 0 1 2 3 4 5 6 7 8 9 10							16x b92	4x c579	16x d20	<table border="1"><tr><td>D</td></tr><tr><td>5/7</td></tr></table>	D	5/7
D																
5/7																
48x d28	10x d41/2	6x Ø7x50 mm e1	16x Ø6,3x10 mm e50	48x Ø6,3x10 mm e51	36x Ø8x30 mm f1	2x Ø10x50 mm f35	4x M4x25 mm j8	10x k1	2x l63	16x l2	2x 86x21x151,5 n14/2	4x n267				
2x Ø5x60 mm p17	40x Ø3,5x16 mm p38	44x Ø3,5x15 mm p51	30x Ø15x12 mm #16 r1	30x 20/11 r42	15x Ø 20mm s68	1x 4 mm z1										



A	B	C (mm)			D
1	S611-0006	2042	496	19	6/7
2	S611-0007	2042	496	19	6/7
3	S611-0008	2042	496	19	7/7
4	S611-1009	2173	540	15	1/7
5	S611-1010	2173	540	15	1/7
6	S611-1011	2085	540	18	7/7
7	S611-1012	2085	540	18	3/7
8	S611-1013	2085	540	18	2/7
9	S611-2003	2028	578	22	4/7
10	S611-3005	1966	540	15	4/7
11	S611-3006	478	519	15	3/7, 5/7
12	S611-4001	1966	73	15	2/7
13	S611-5013	1998	80	22	2/7
14	S611-5014	1998	43	22	2/7
15	S611-9006	2095	488	2,5	2/7
16	S611-9007	2095	488	2,5	2/7
17	S611-9008	2095	488	2,5	2/7
18	dr-474	474	22	15	2/7







1 

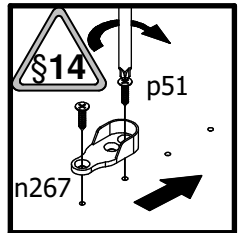
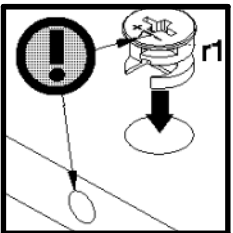
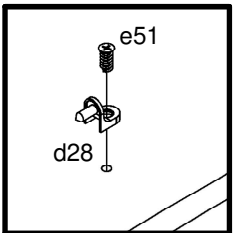
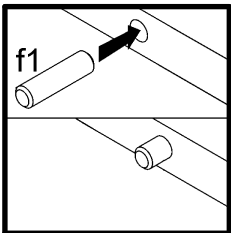
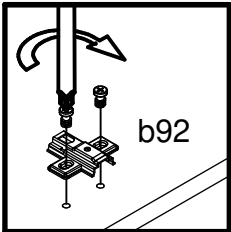
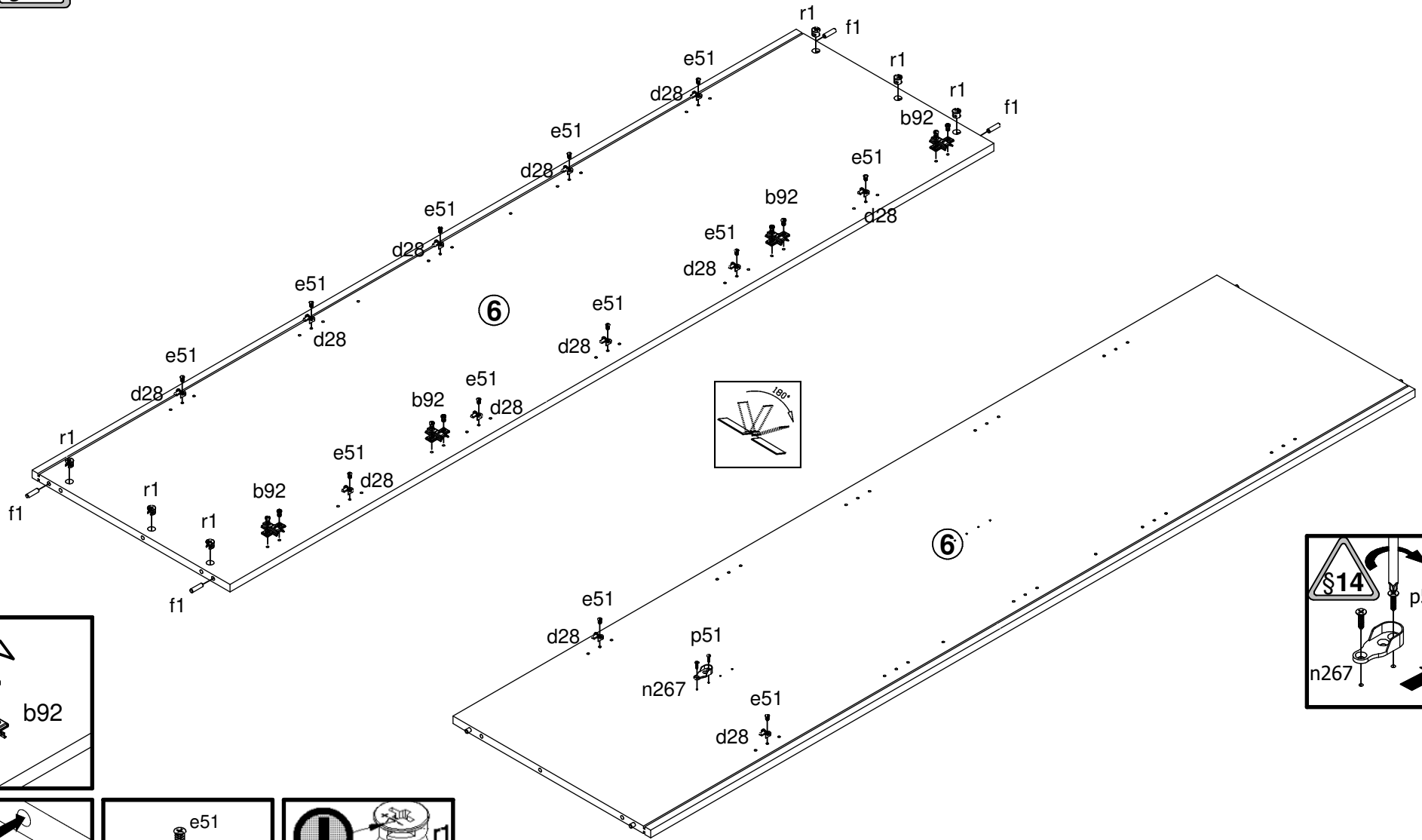

8x  b92	4x  d28	4x  e51 Ø6.3x10 mm
8x  f1 Ø8x30 mm	4x  k1	2x  n267
12x  r1 Ø15x12 mm #16	4x  p51 Ø3.5x15 mm	15x  r42 20/11

2 





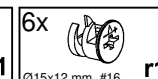
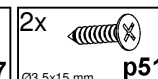
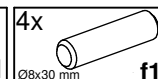
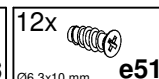
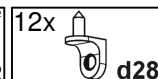
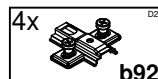
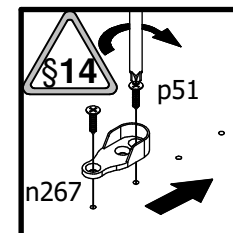
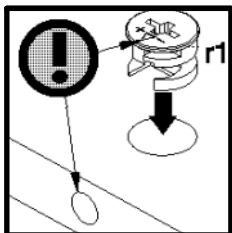
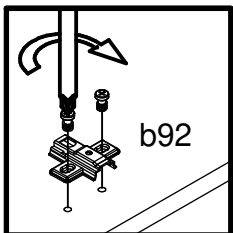
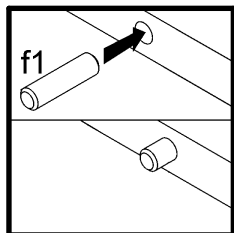
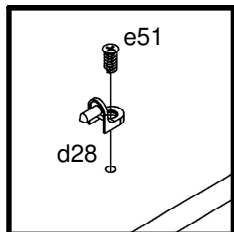
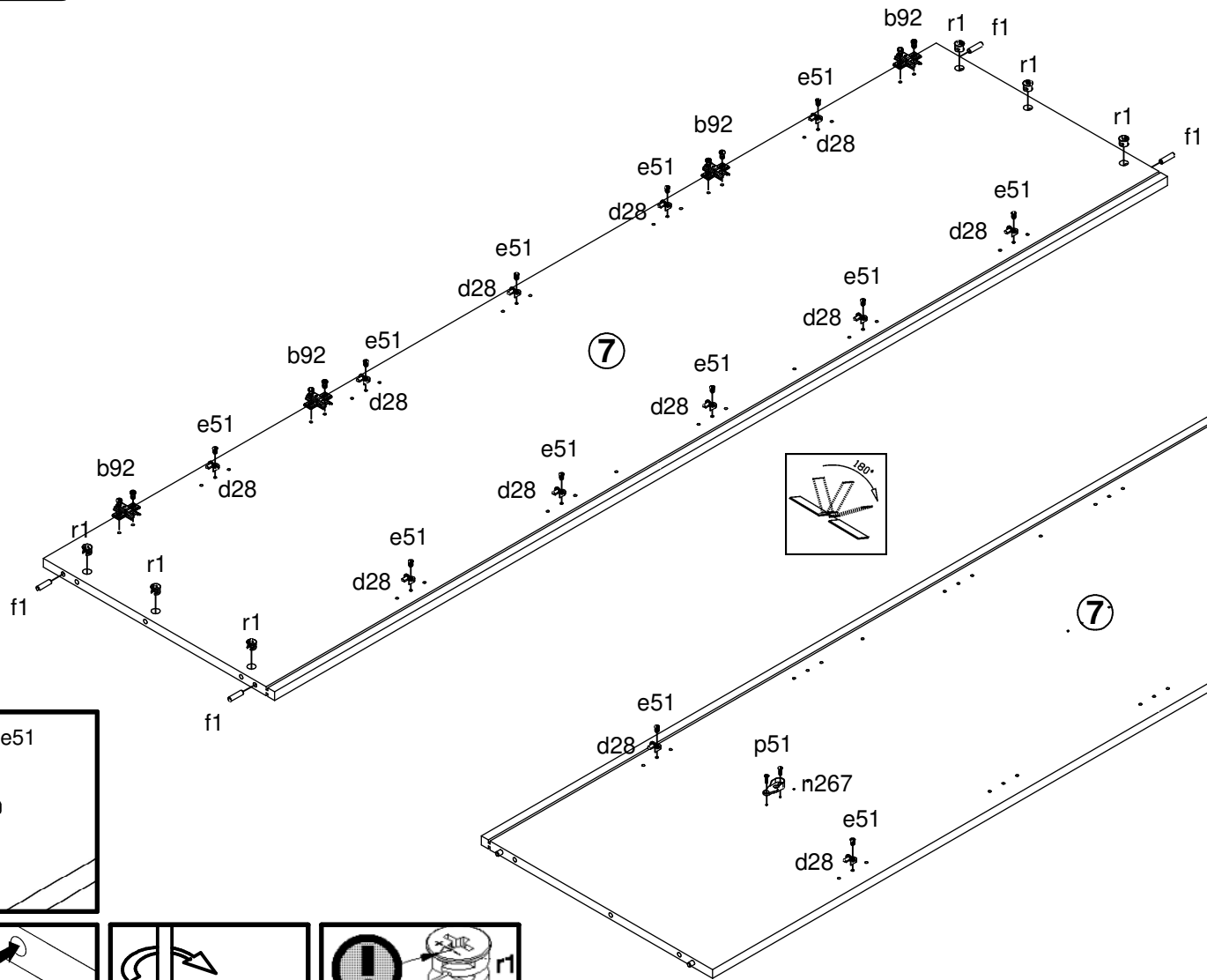

- 8x  **b92**
- 4x  **d28**
- 4x  **e51**
Ø6,3x10 mm
- 8x  **f1**
Ø8x30 mm
- 2x  **n267**
- 4x  **p51**
Ø3,5x15 mm
- 12x  **r1**
Ø15x12 mm #16

3 §2

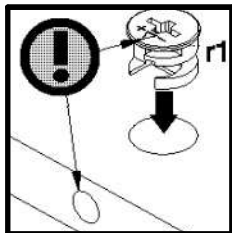
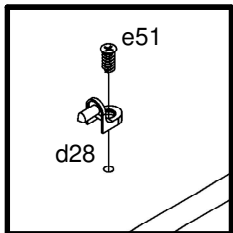
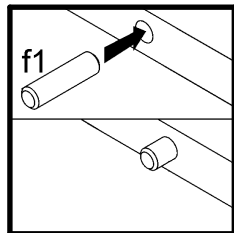
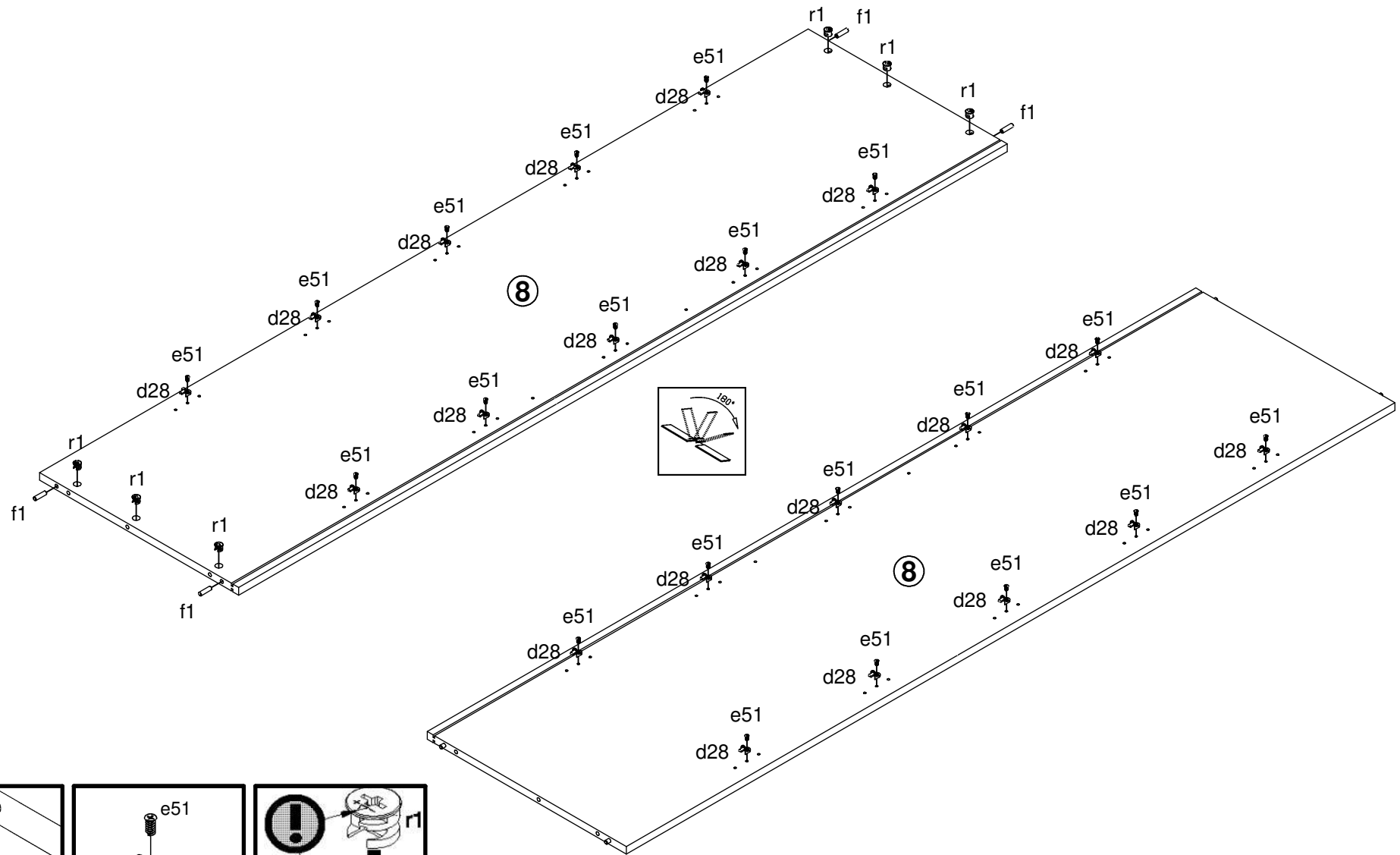

4 



- | | | | |
|--|--|--|---|
| 20x  d28 | 20x  e51
Ø6.3x10 mm | 4x  f1
Ø8x30 mm | 6x  r1
Ø15x12 mm #16 |
|--|--|--|---|

5

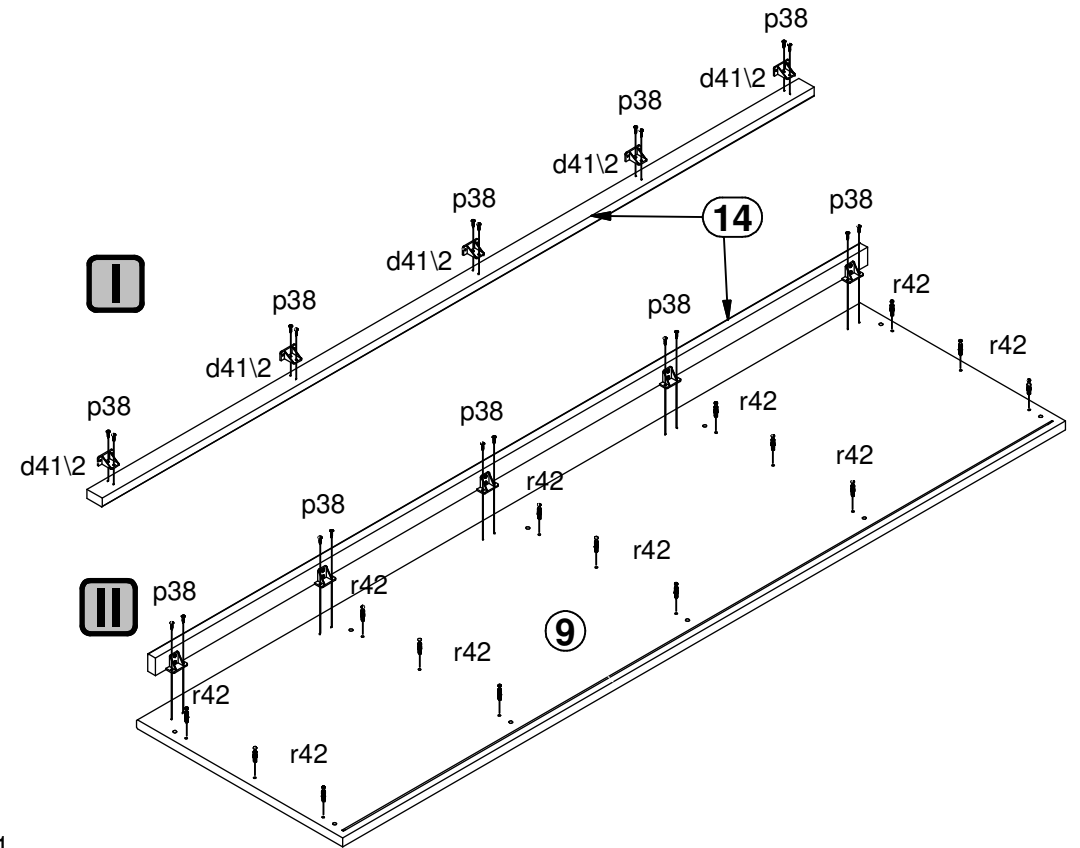
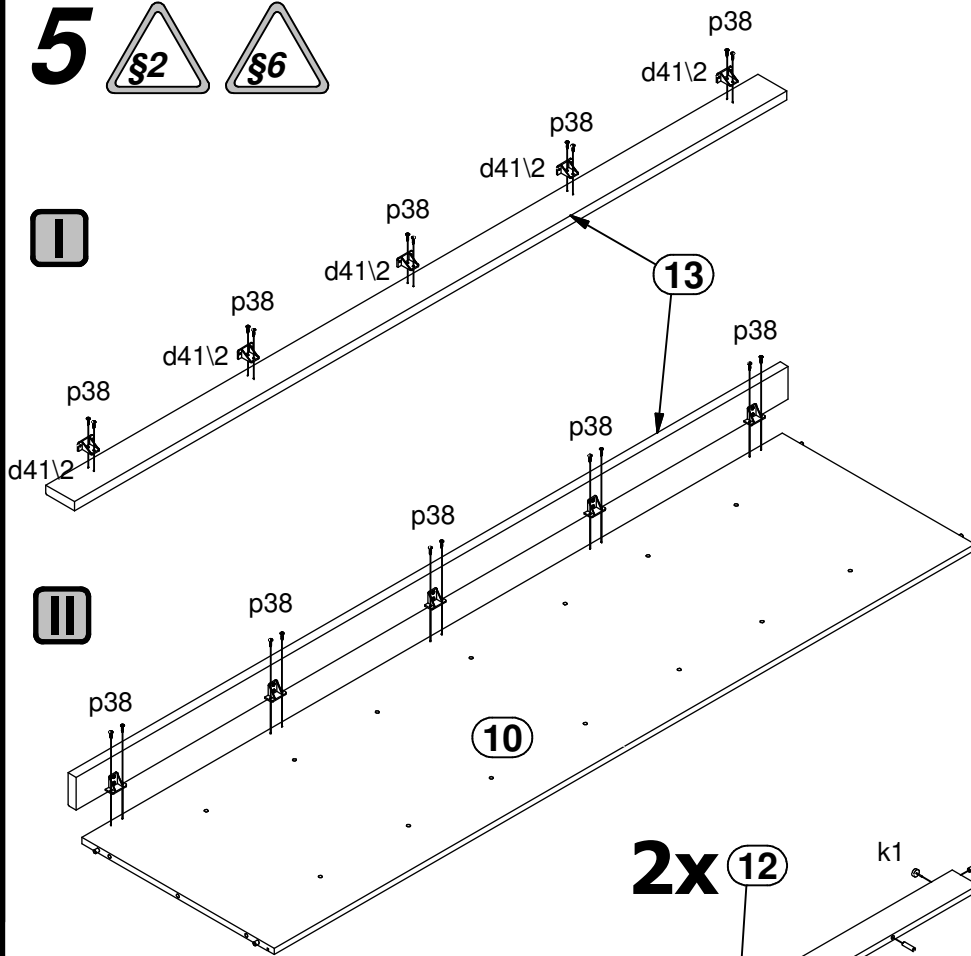

2x 12

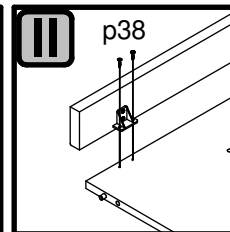
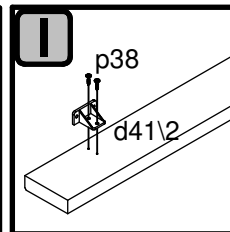
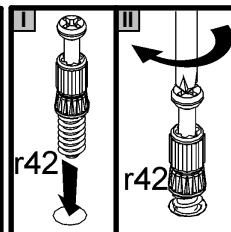
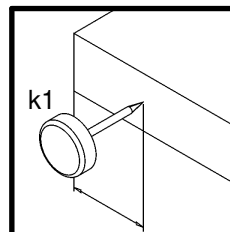
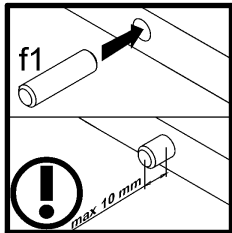
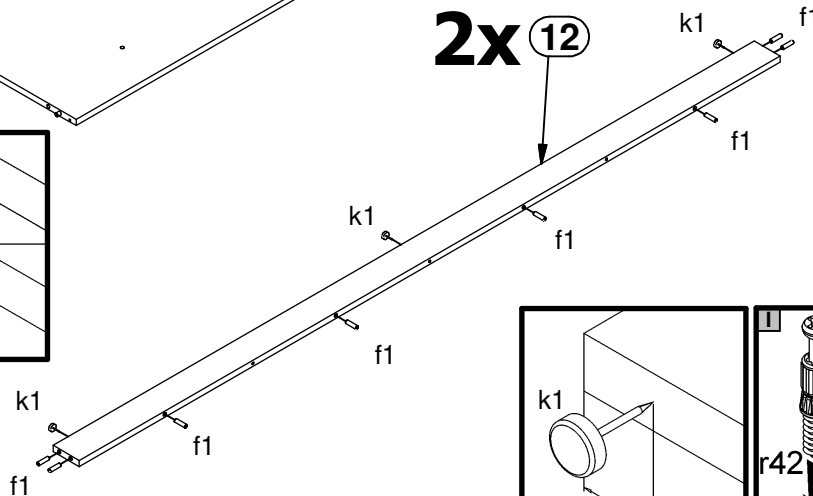

- 40x p38
Ø3,5x16 mm
- 10x d41\2
- 15x r42
20/11
- 3x k1
- 8x f1
Ø8x30 mm

6 

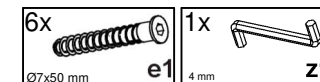
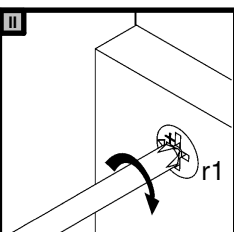
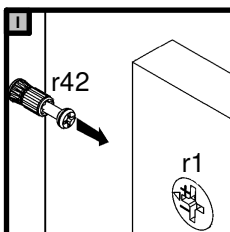
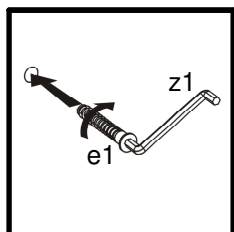
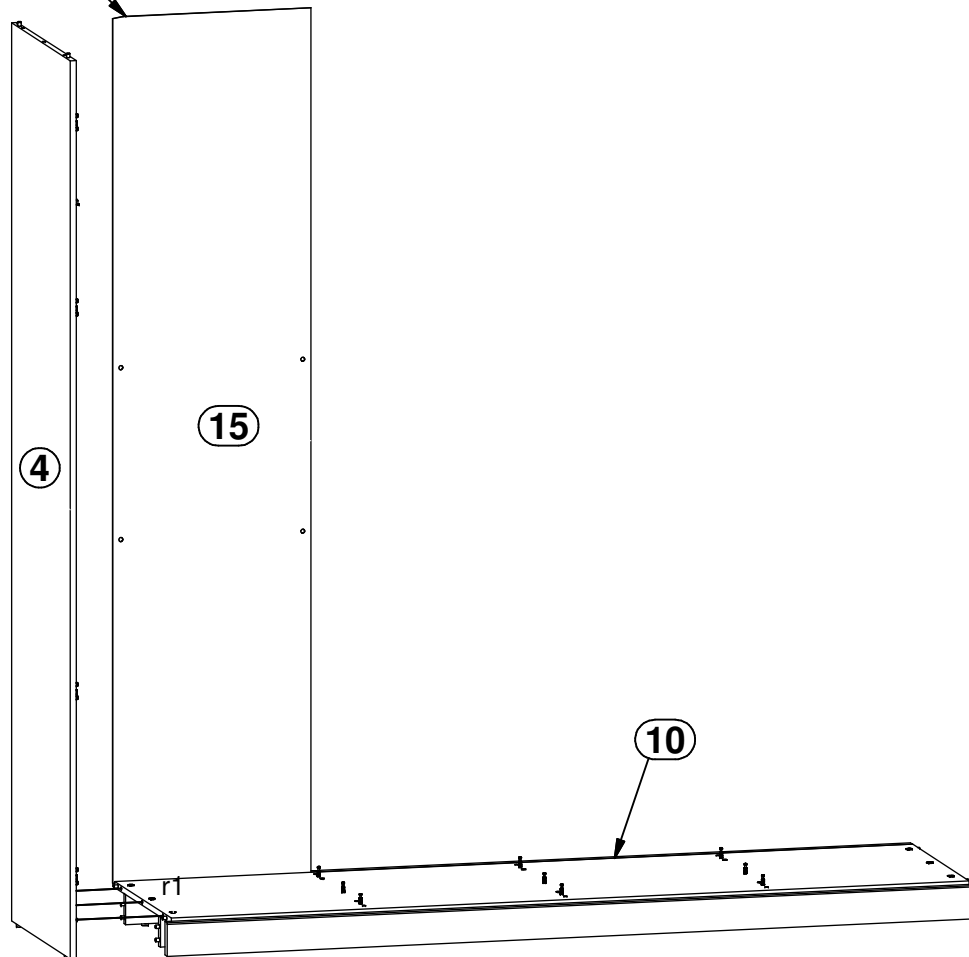
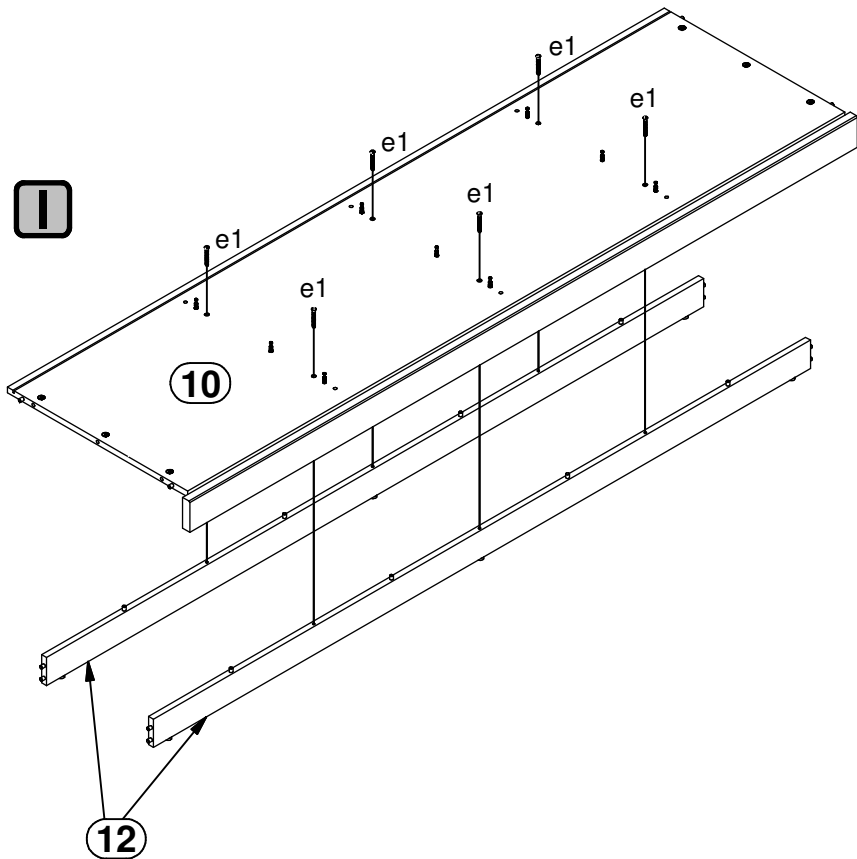
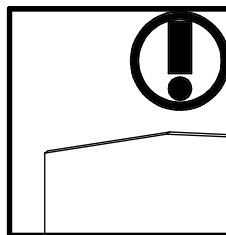

7



I

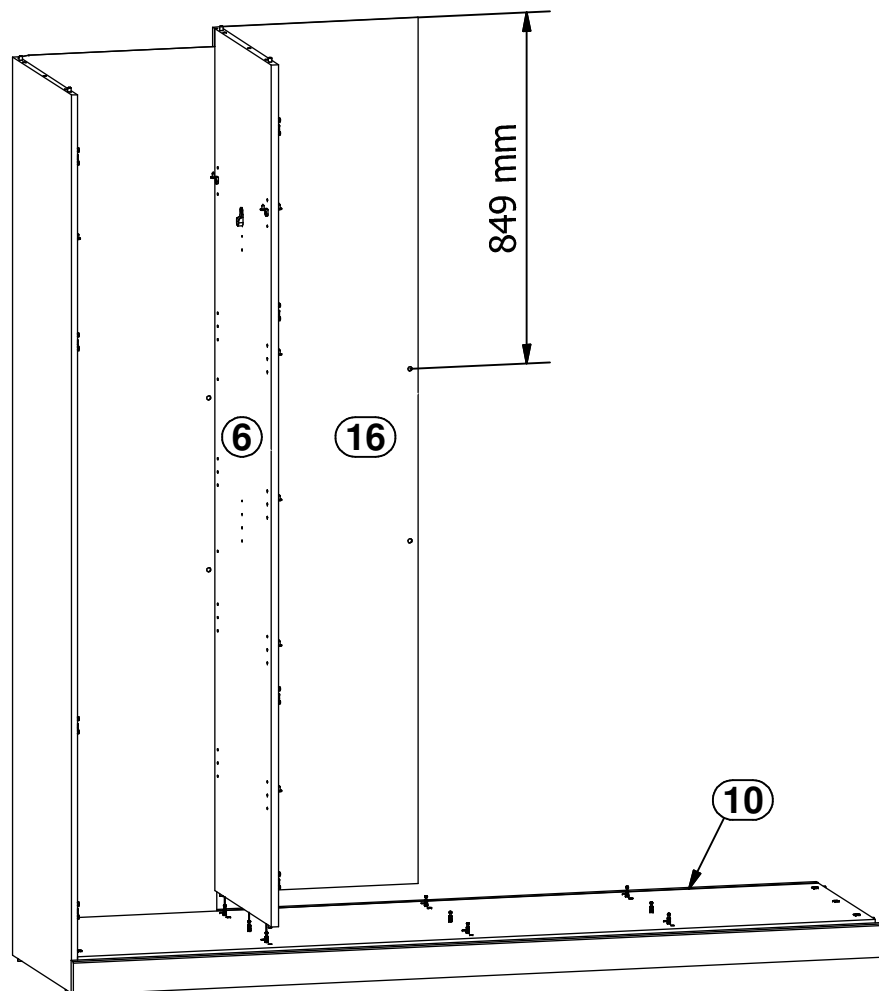

II

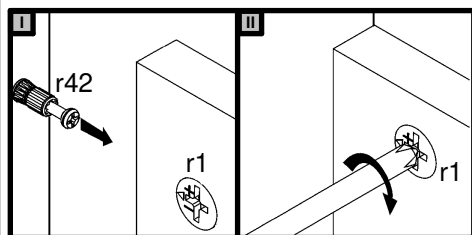
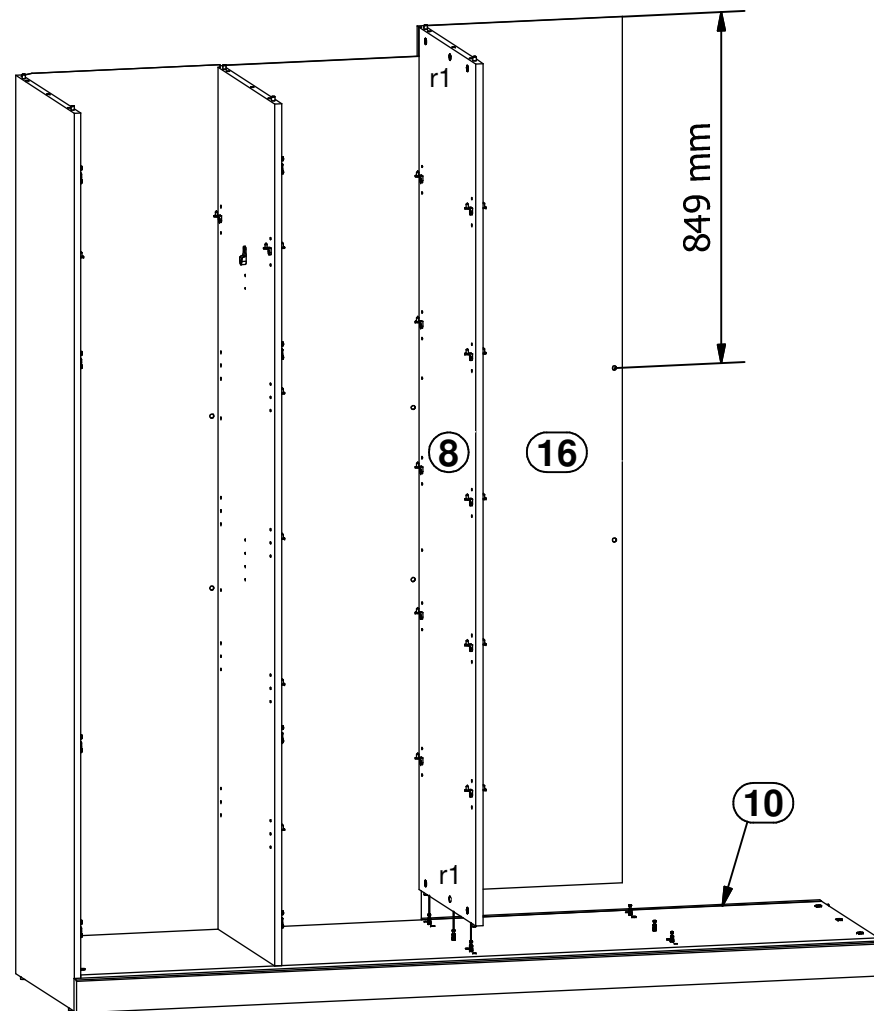

8



I

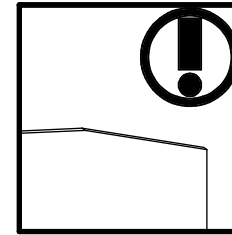
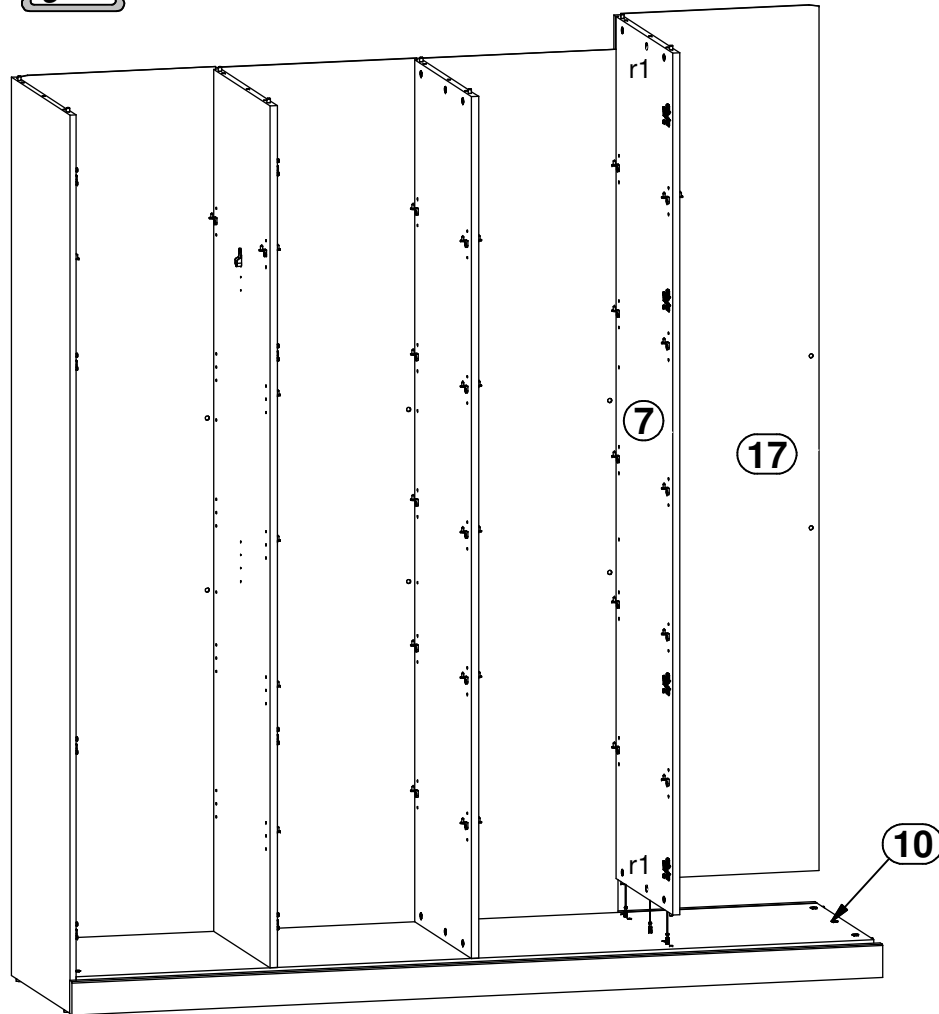

II

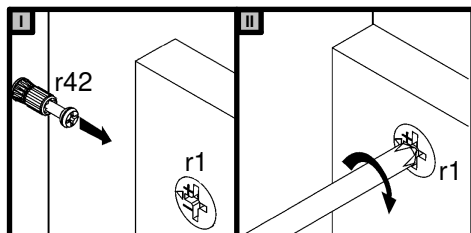
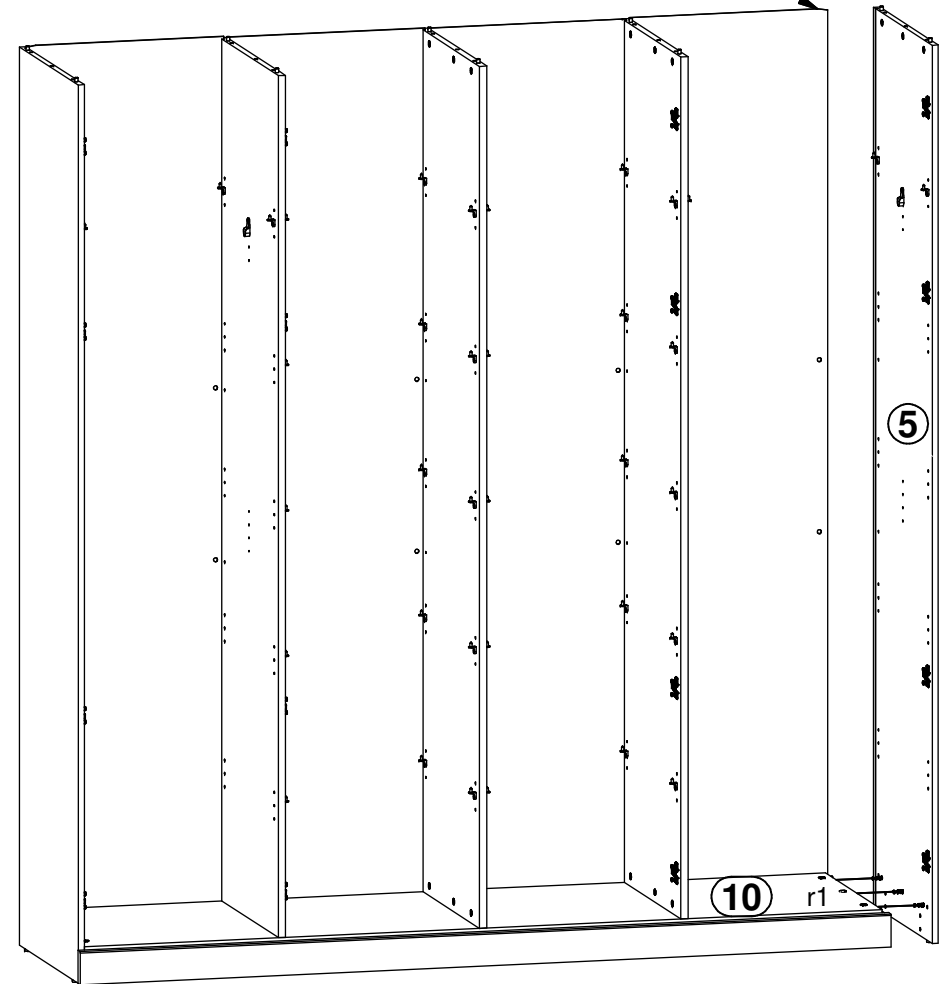

9

I

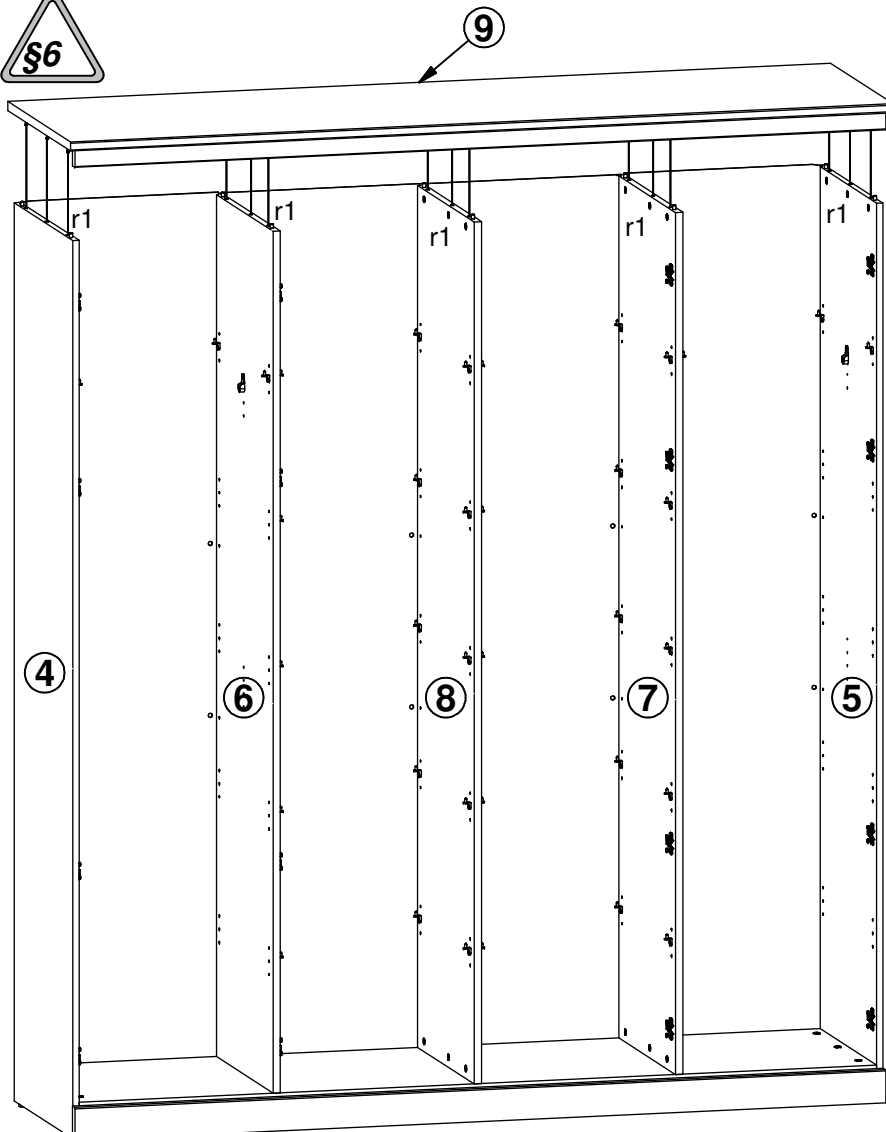

II

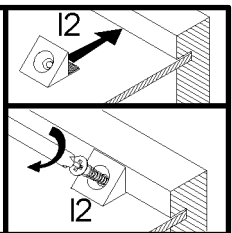
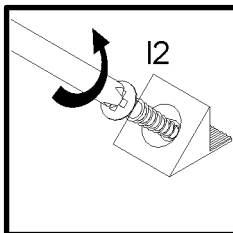
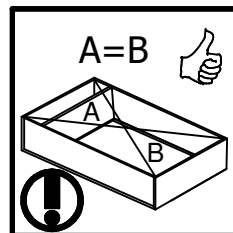
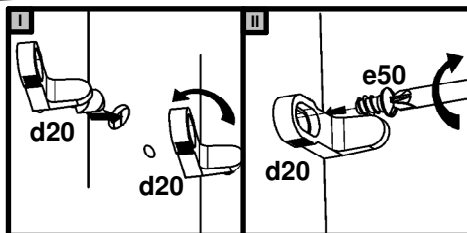
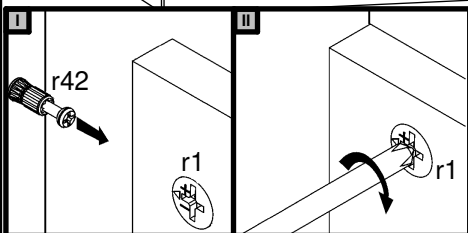
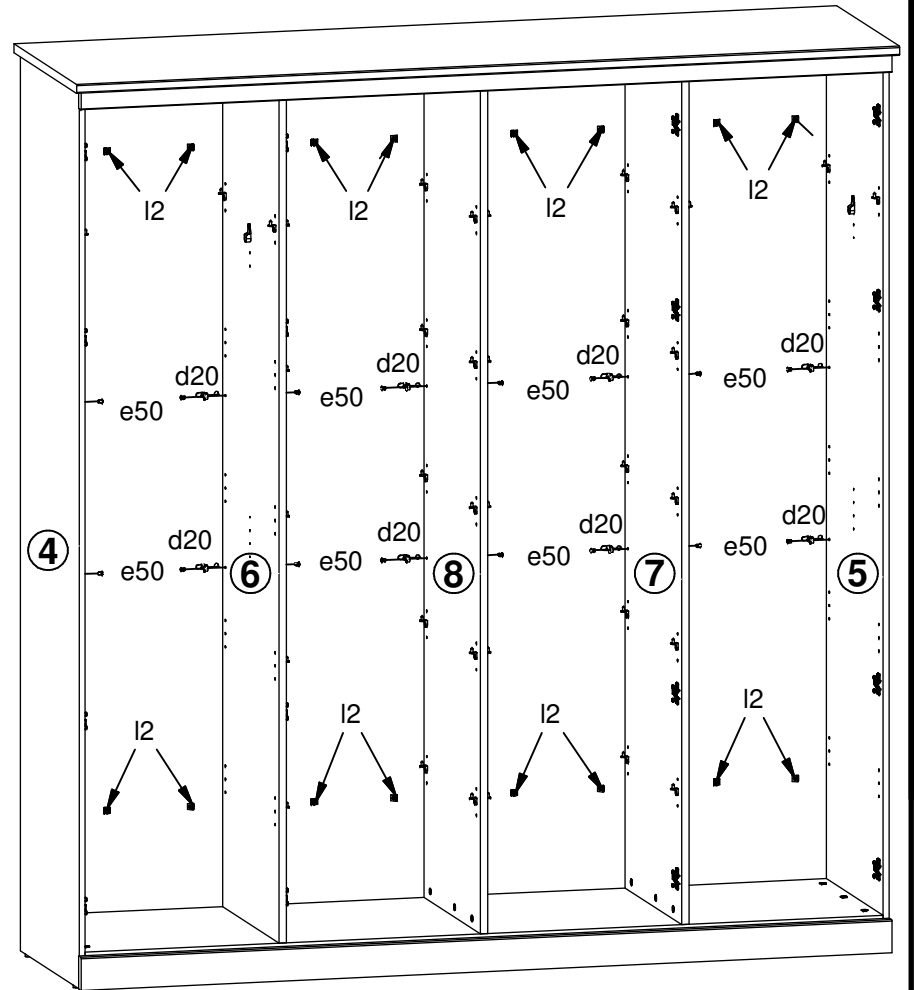





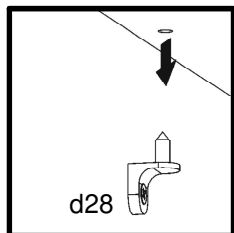
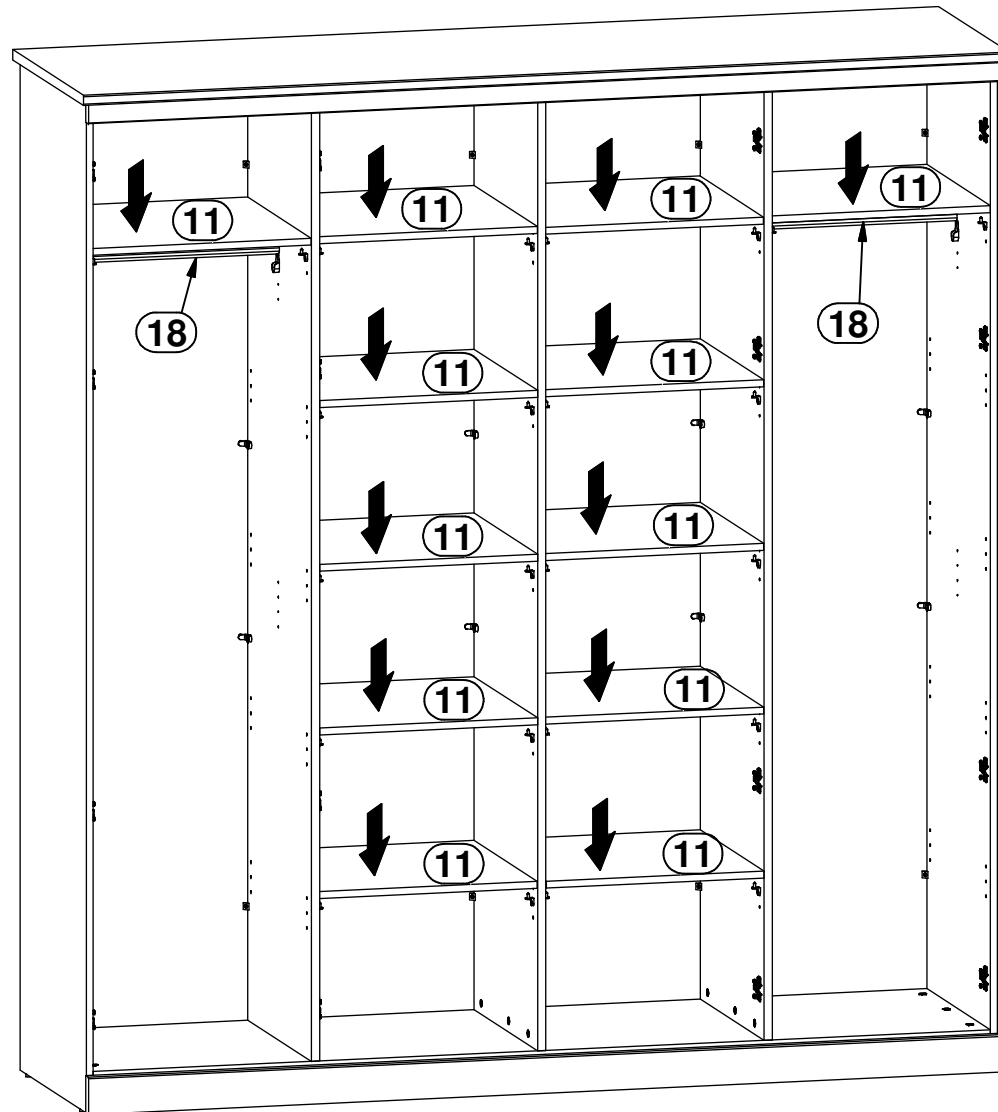

- 16x l2
- 16x e50
- $\varnothing 8.3 \times 10 \text{ mm}$
- 16x d20

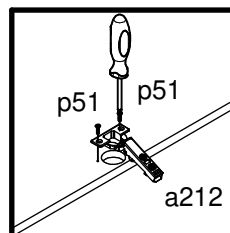
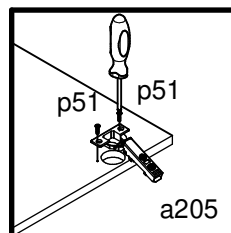
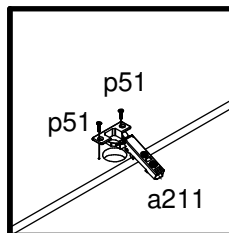
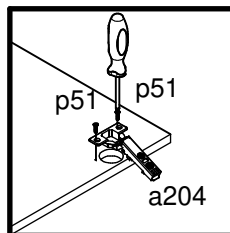
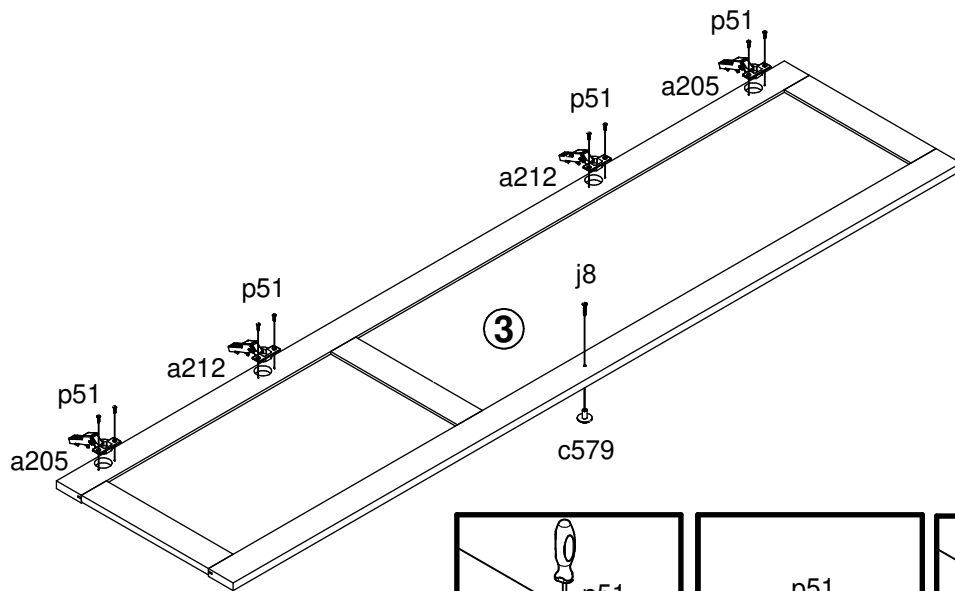
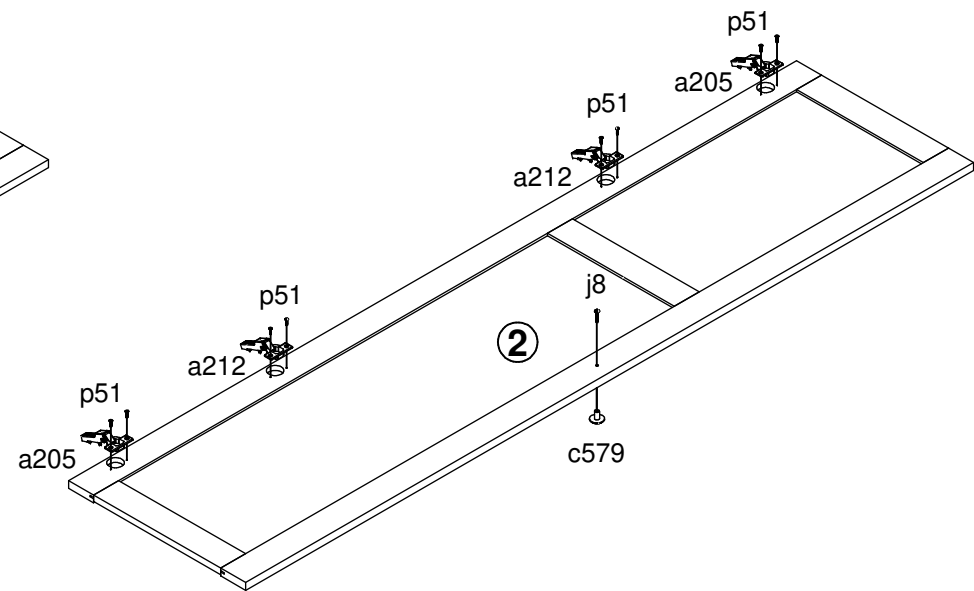
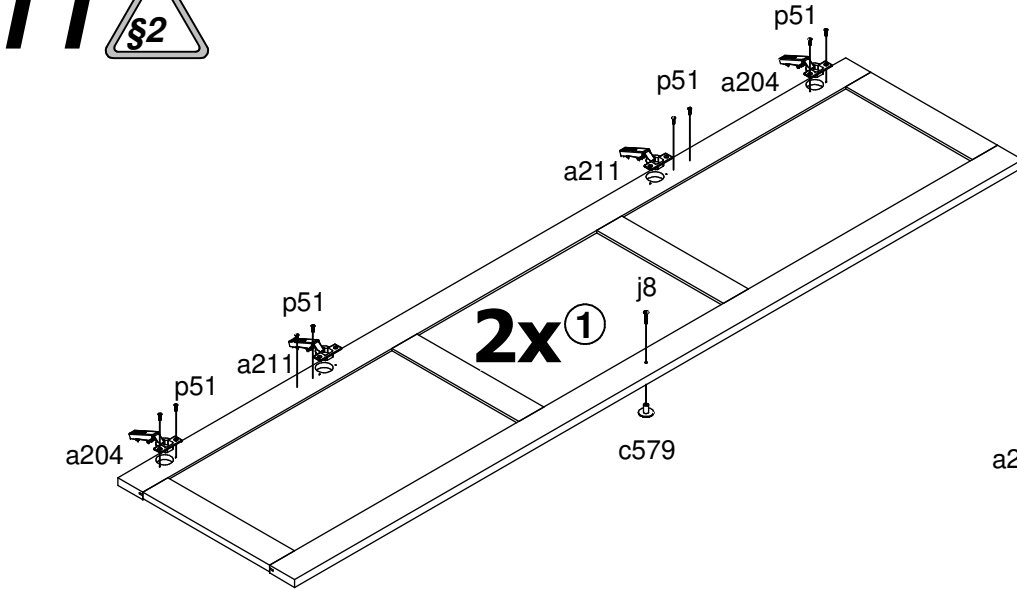
10 

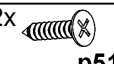

11 

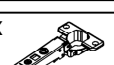

4x  c579	4x  a212
32x  p51 Ø3,5x15 mm	4x  a205
4x  a211	4x  a204

12

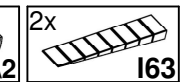
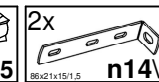
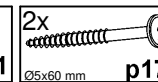
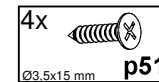
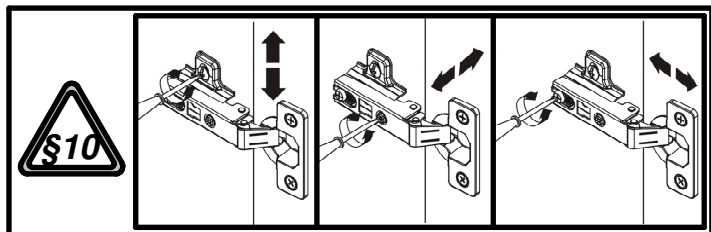
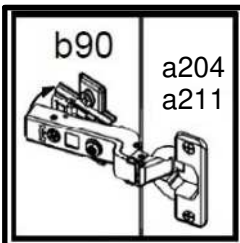
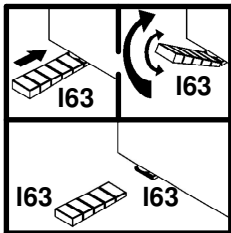
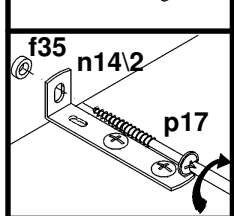
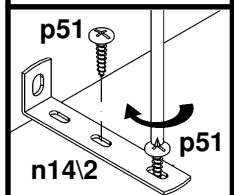
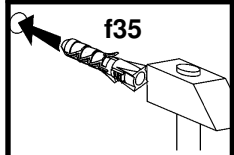
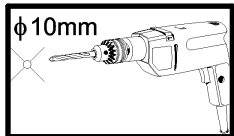
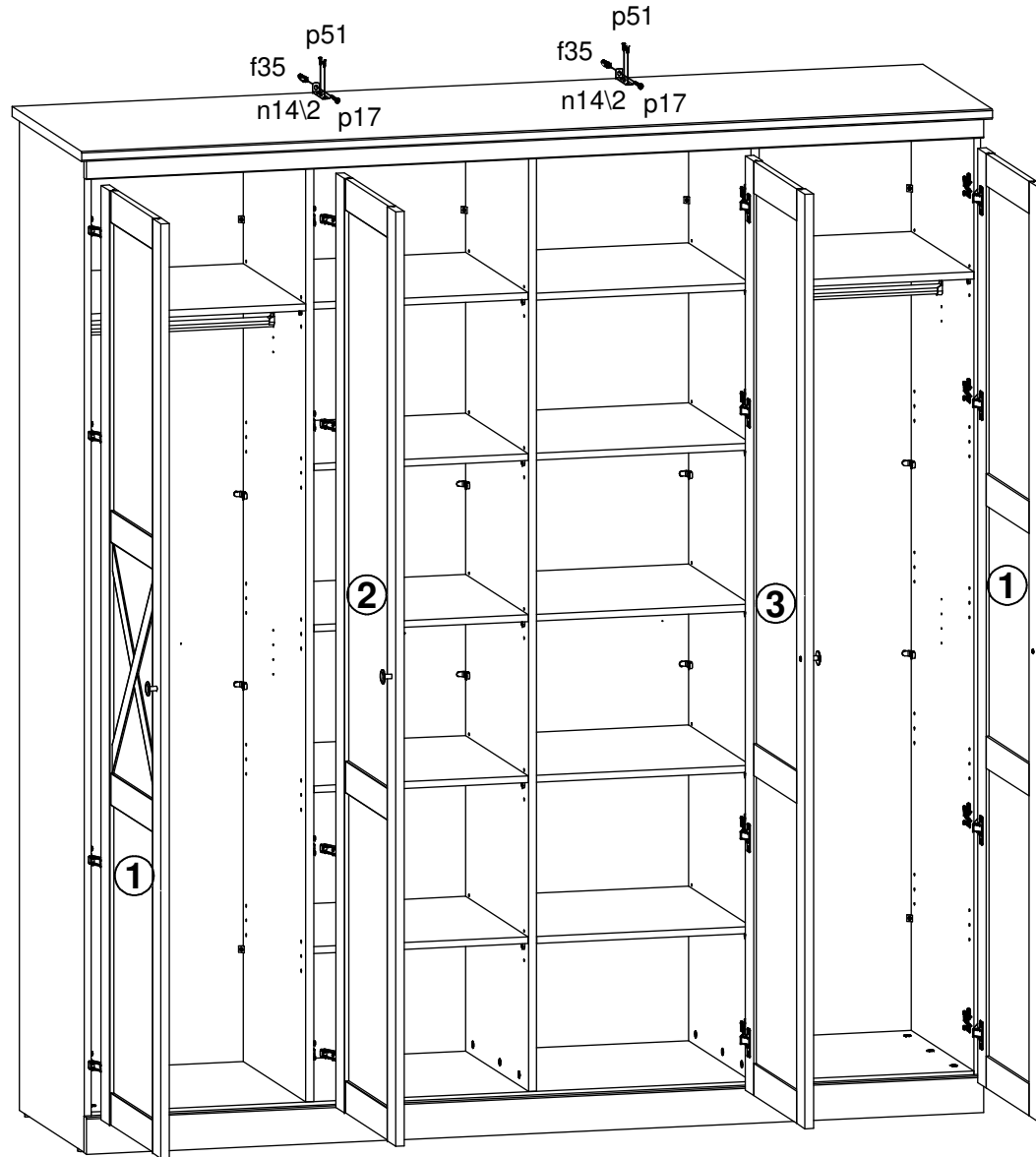

13

