

Ø10 mm

60 min

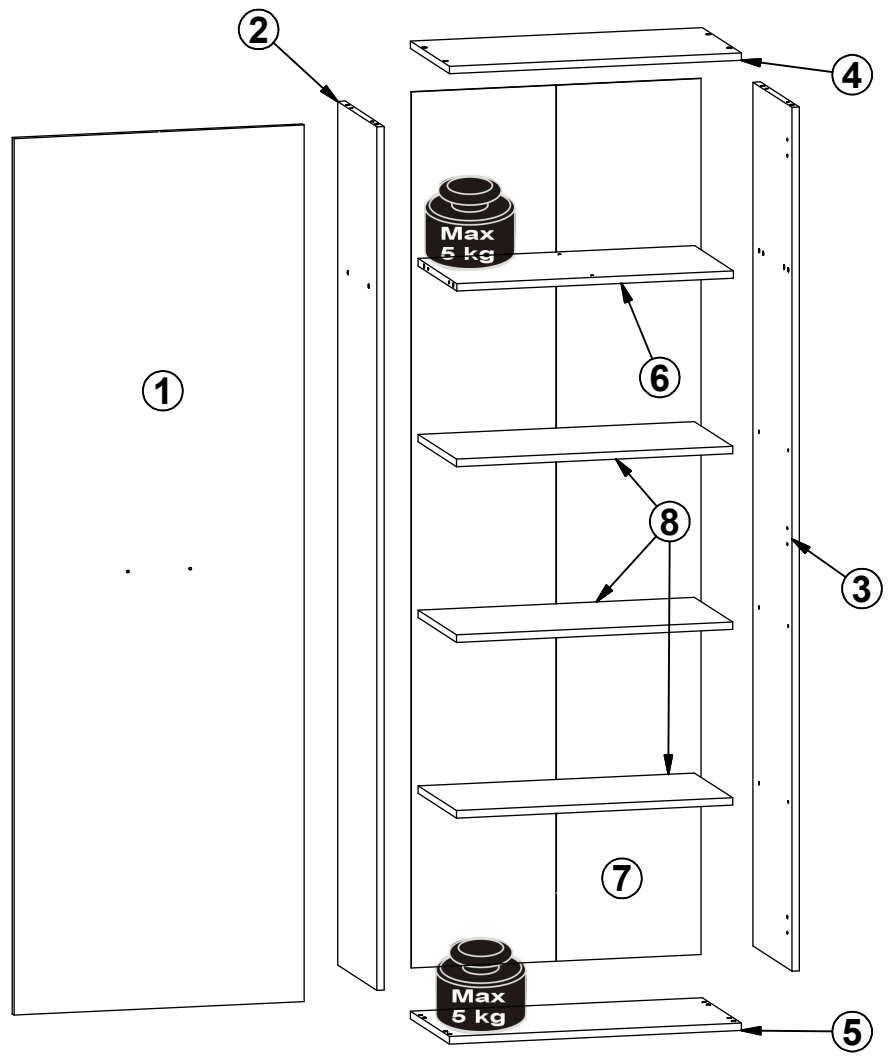

A	B	C (mm)			D
1	S610-0002	1766	596	15	1/1
2	S610-1003	1740	299	15	1/1
3	S610-1004	1740	299	15	1/1
4	S610-2003	600	300	15	1/1
5	S610-2004	600	300	15	1/1
6	S610-3002	568	298	15	1/1
7	S610-9302	1765	595	2,5	1/1



8	S610-3003	567	293	15	1/1
---	-----------	-----	-----	----	-----

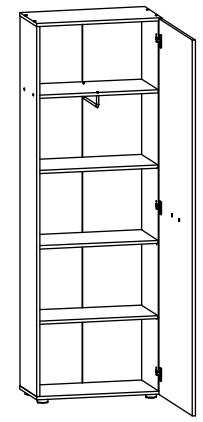
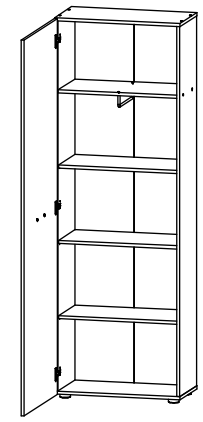
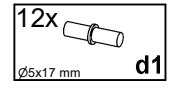

A

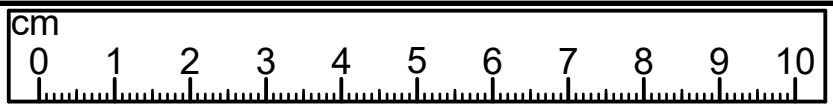

B

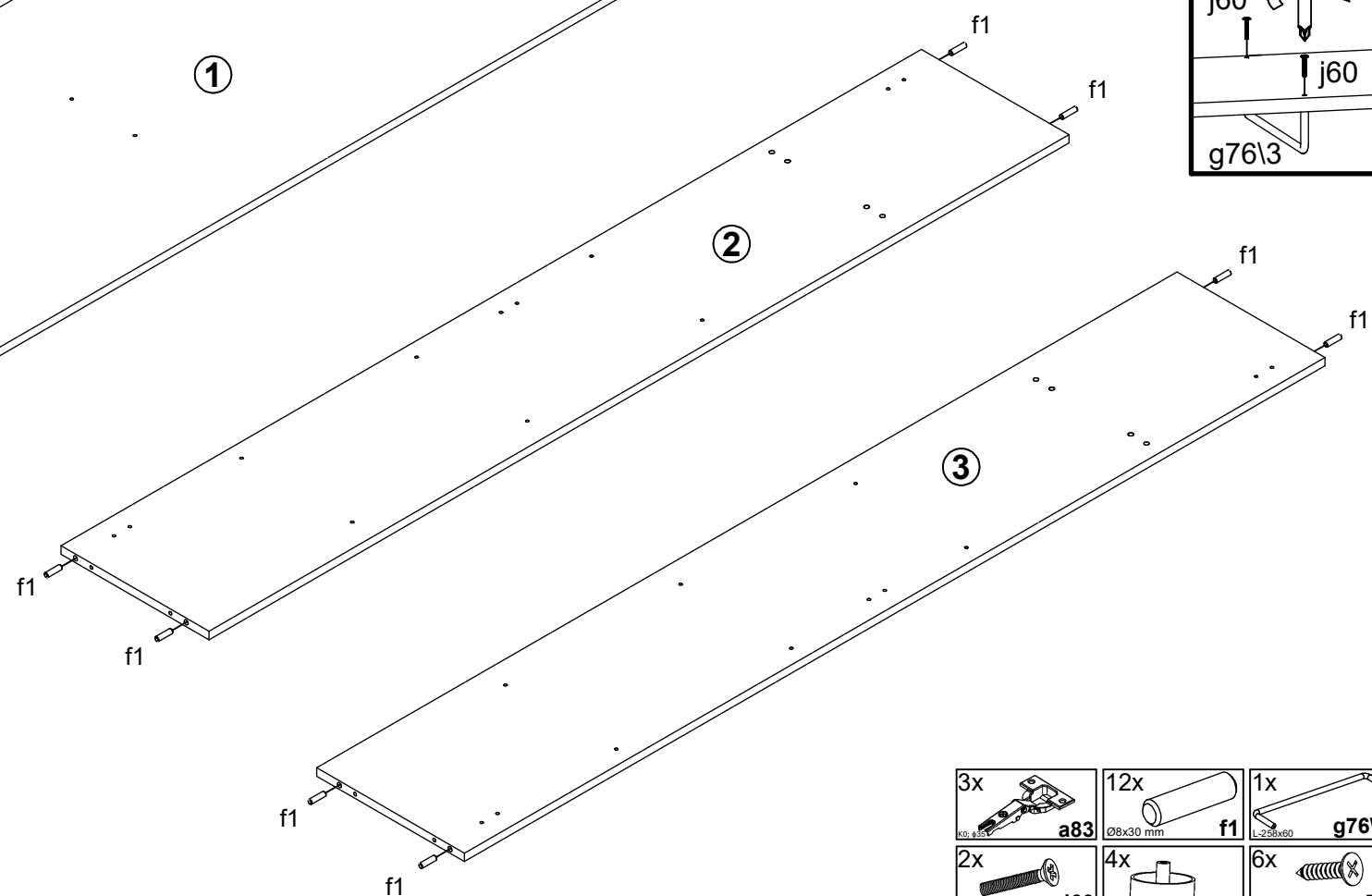
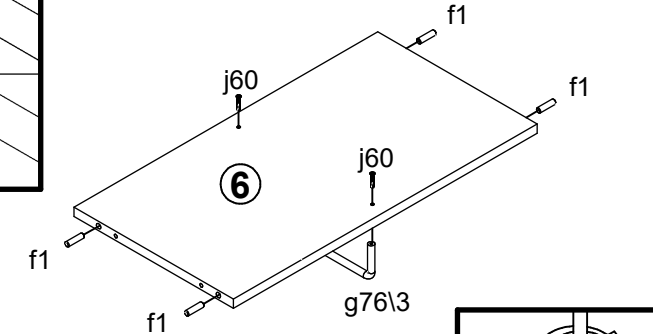
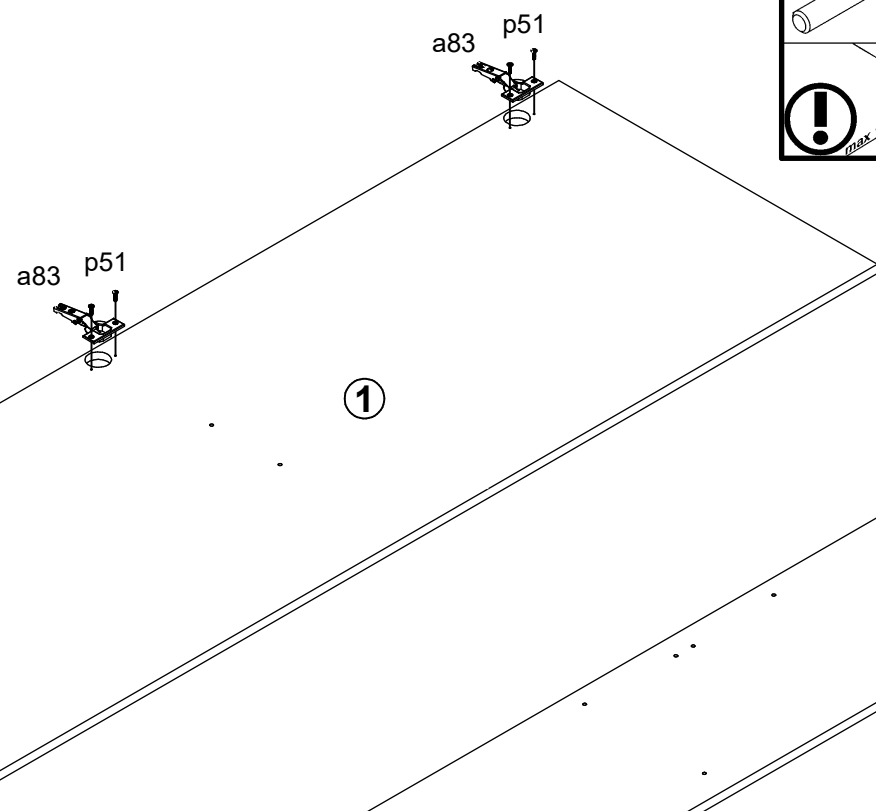
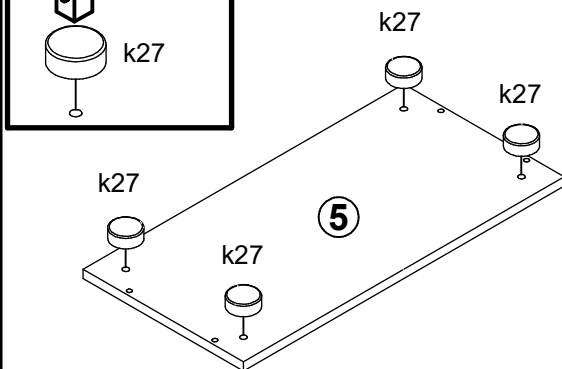
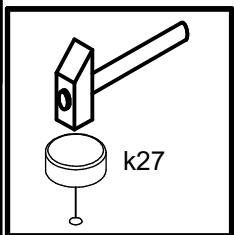
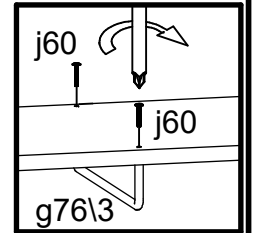
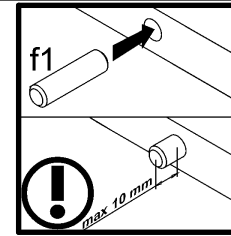
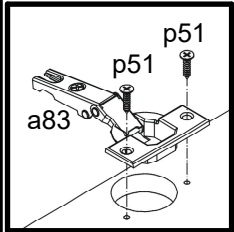

D
1/1

3x a83	3x b32	1x c310	12x e1	12x f1	1x f35	1x g76/3	2x j60	4x k27	45x l1	1x n142	1x p17	8x p51
2x p87	4x s1	1x z1										

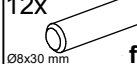
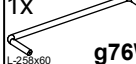

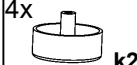
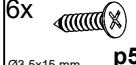
3x K0: 4.85  a83	12x  f1 Ø8x30 mm	1x  g76\3 L-238x60
2x  j60 M4x22 mm	4x  k27	6x  p51 Ø3,5x15 mm

2 

I

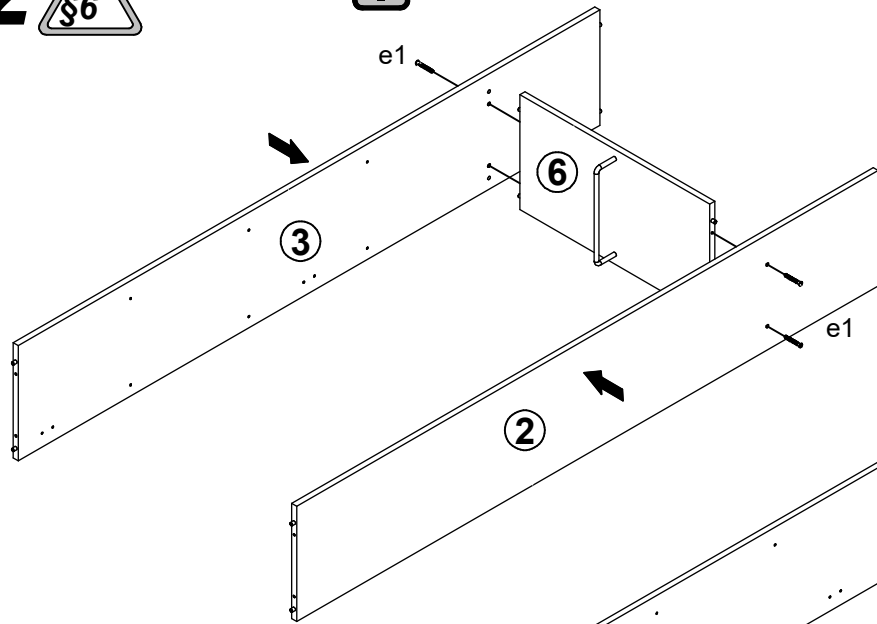

II

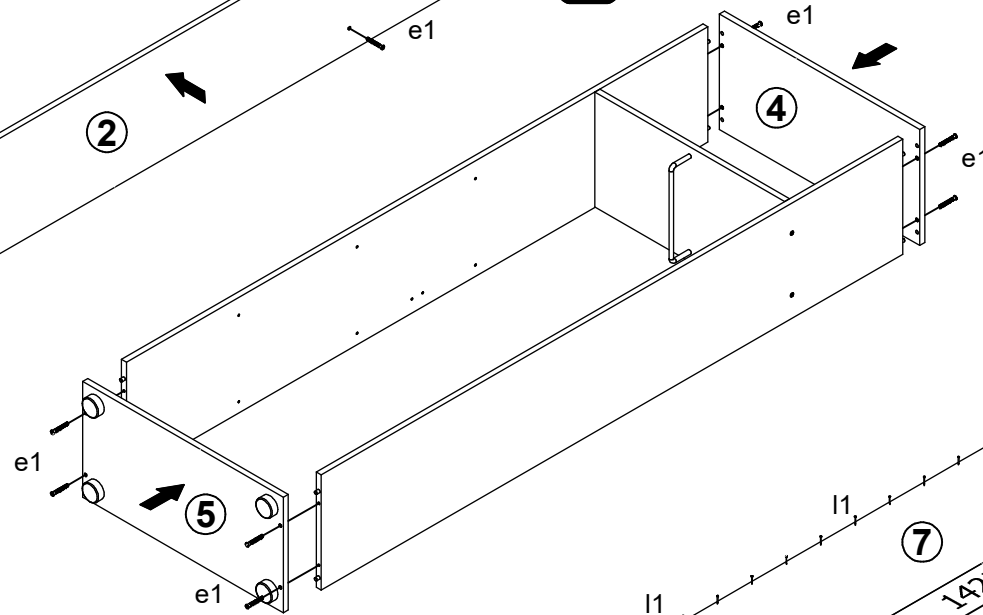

III

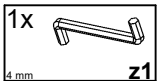
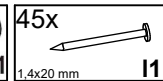
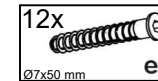
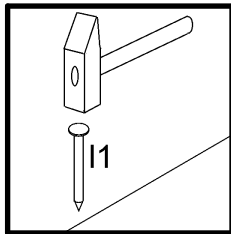
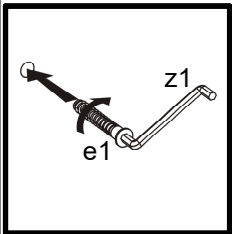
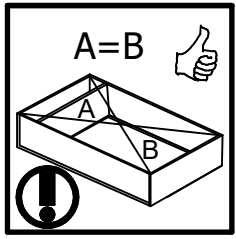
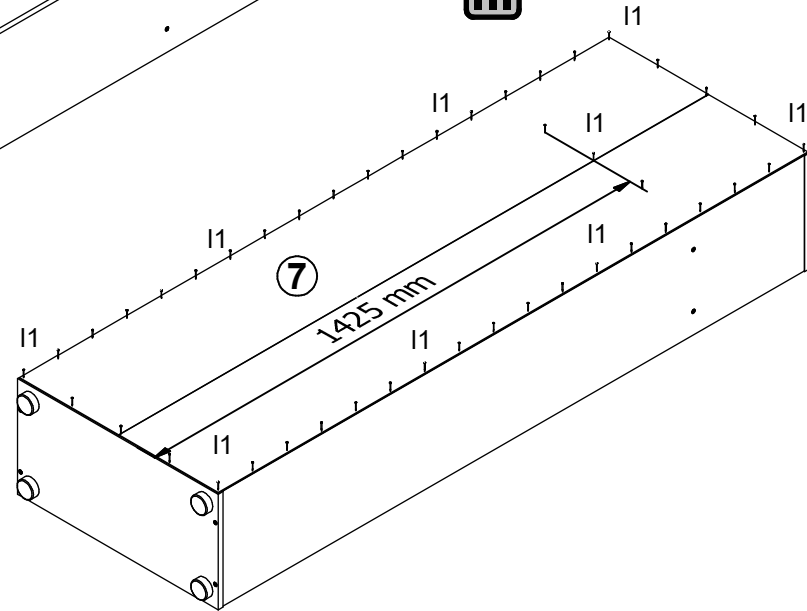

3 §6

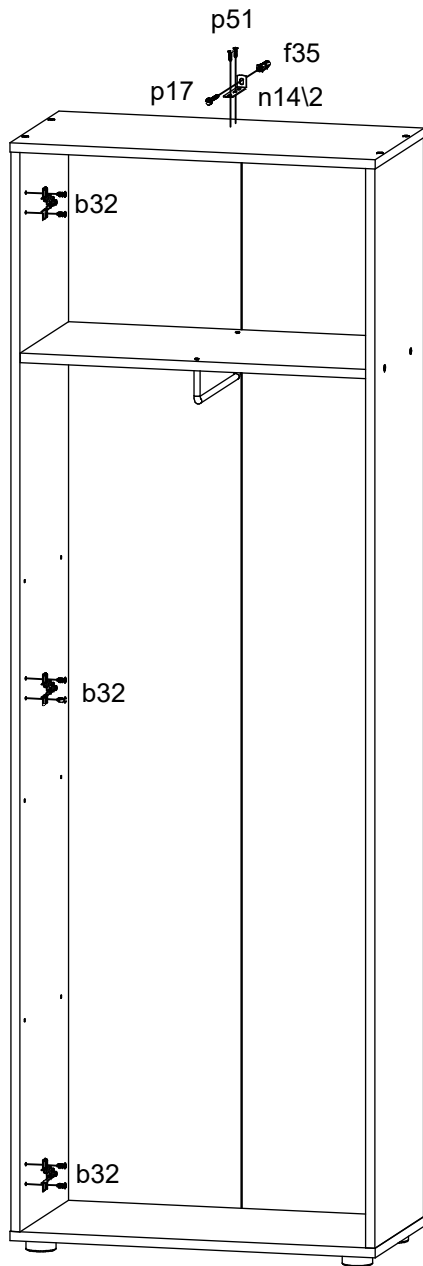

A

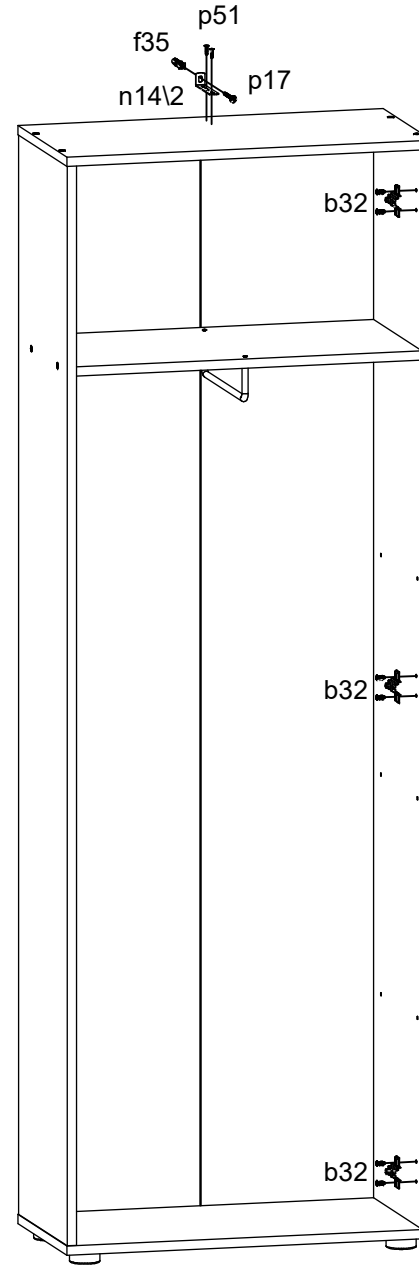
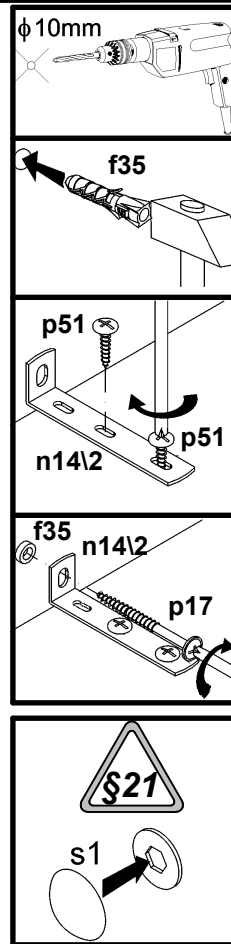

B

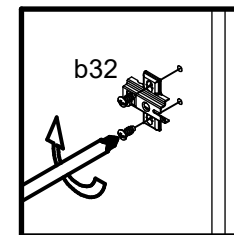
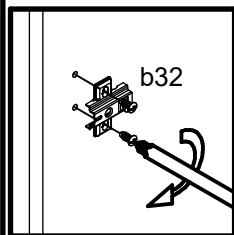

- | | | |
|---------------|---------------|-----------------|
| 3x

b32 | 1x

f35 | 1x

n14\2 |
| 1x

p17 | 2x

p51 | 4x

s1 |

4 

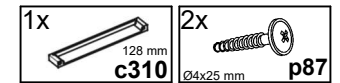
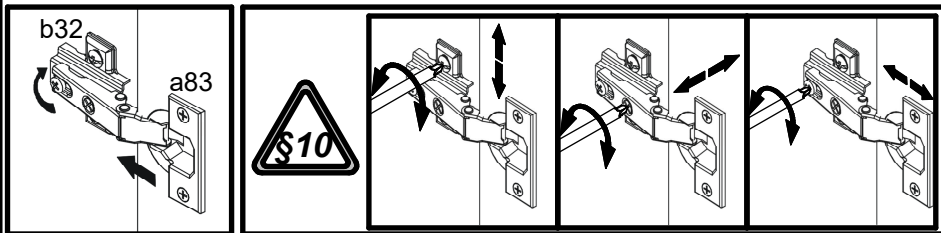
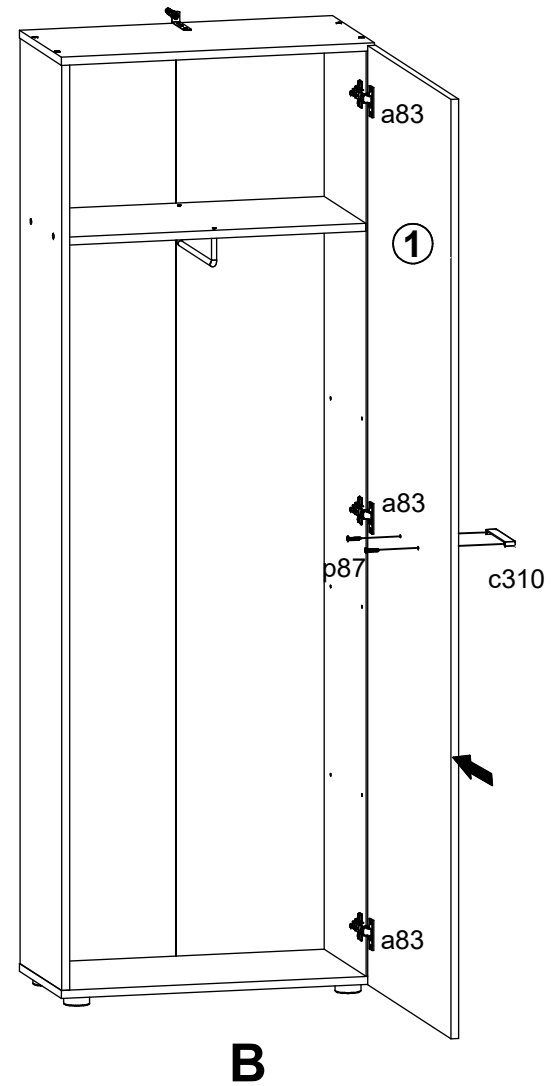
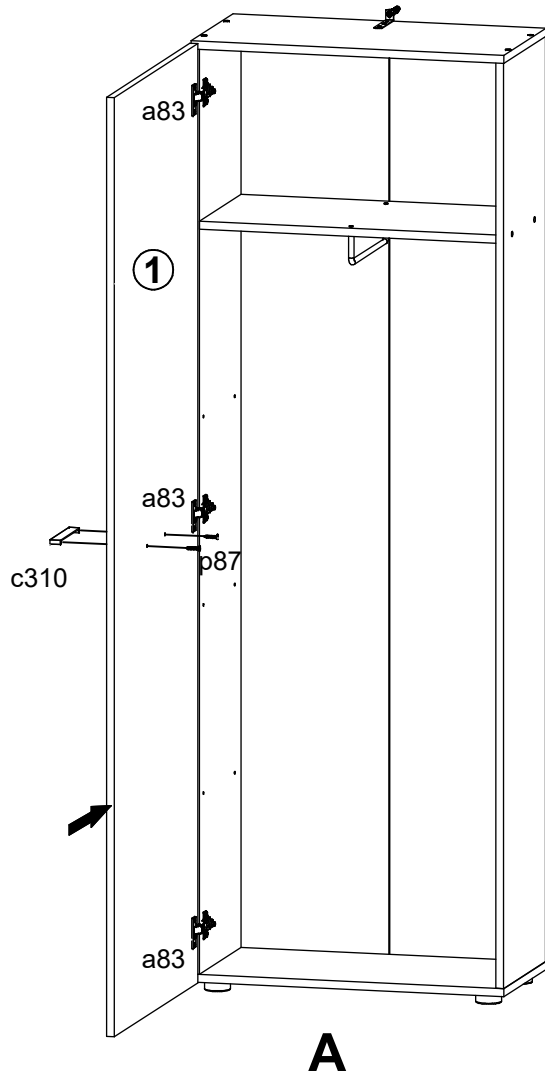

5 §6 §14

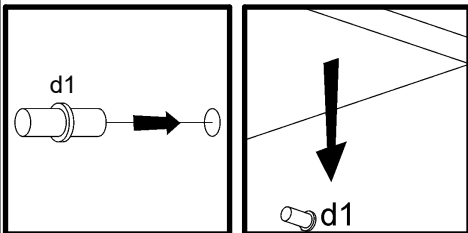
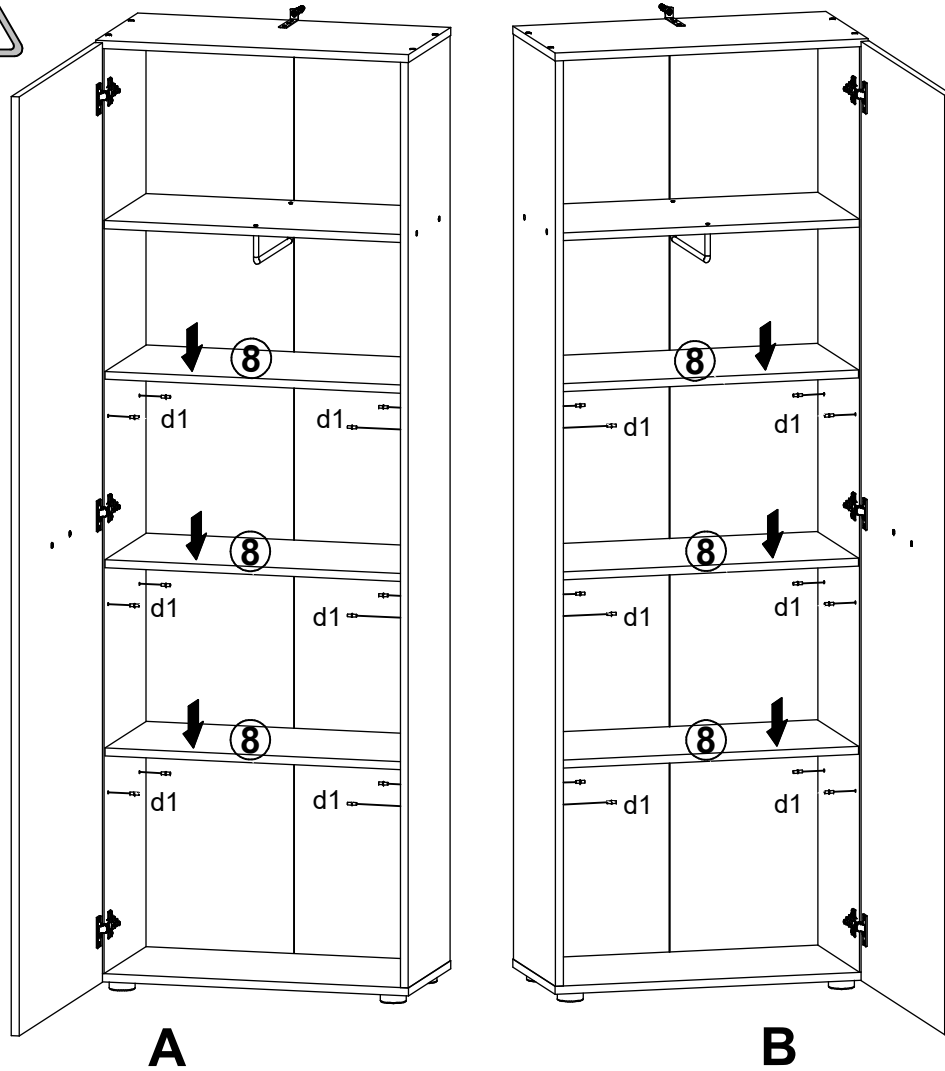

12x
Ø5x17 mm d1

6

