

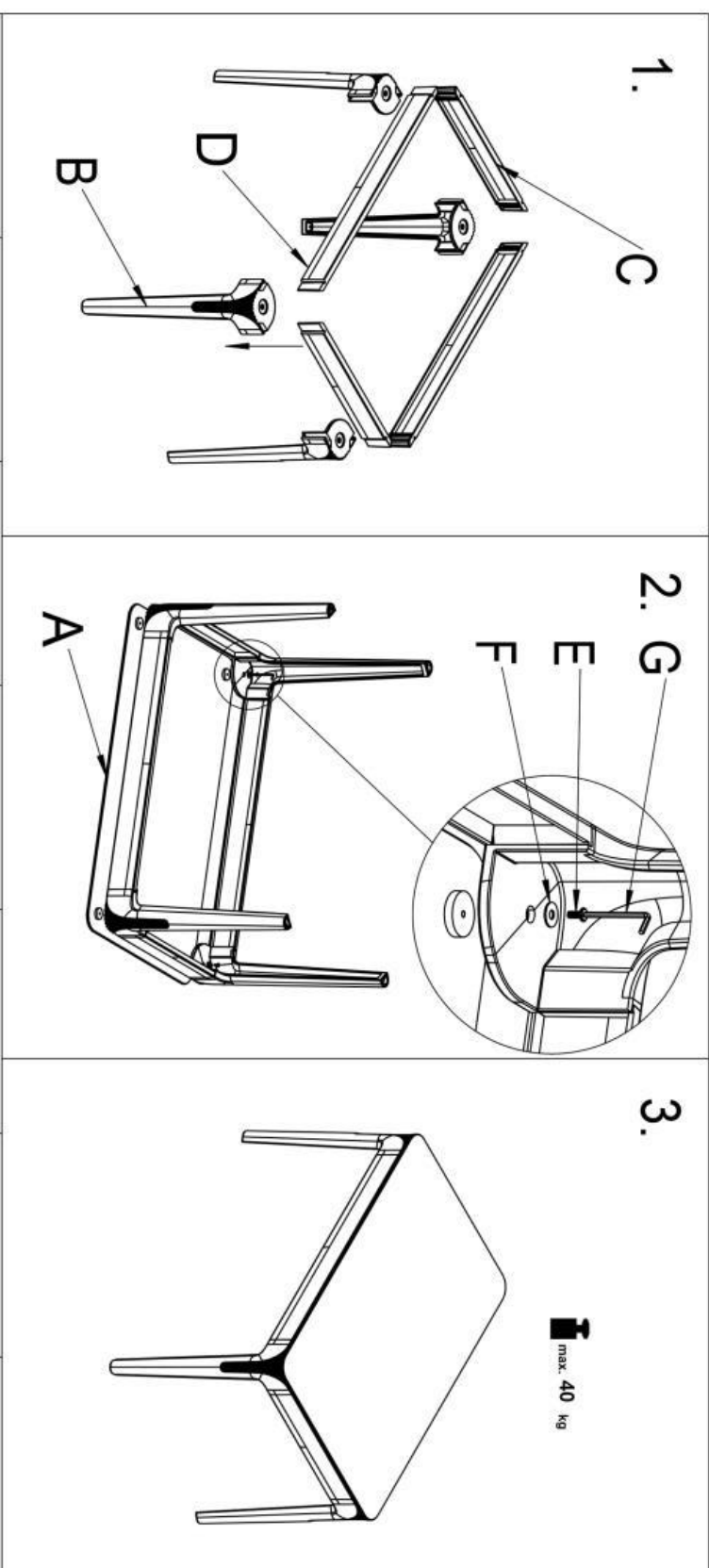

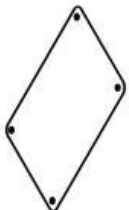

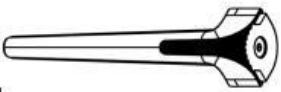

GOMEZ



| | | | | | | |
|--|--|--|--|--|--|--|
| <p>A</p>  <p>X 1</p> | <p>B</p>  <p>X 4</p> | <p>C</p>  <p>X 2</p> | <p>D</p>  <p>X 2</p> | <p>E</p>  <p>X 4</p> | <p>F</p>  <p>X 4</p> | <p>G</p>  <p>X 1</p> |
|--|--|--|--|--|--|--|

HALMAR Sp. z o.o.
 ul. Centralnego Okręgu Przemysłowego 2, 37-450 Stalowa Wola, POLSKA / POLAND
 tel. +48 15 843 28 10, fax: +48 15 842 19 57, e-mail: office@halmar.com.pl

v.1

NOWOŚĆ