

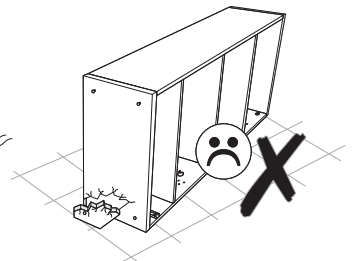

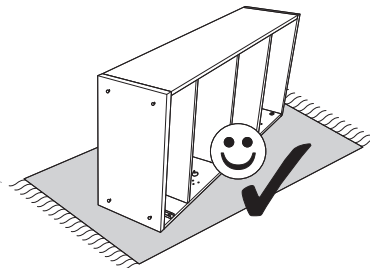

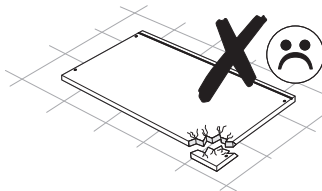

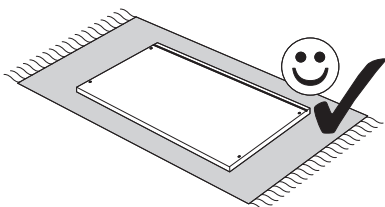

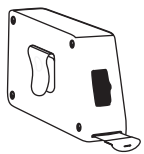
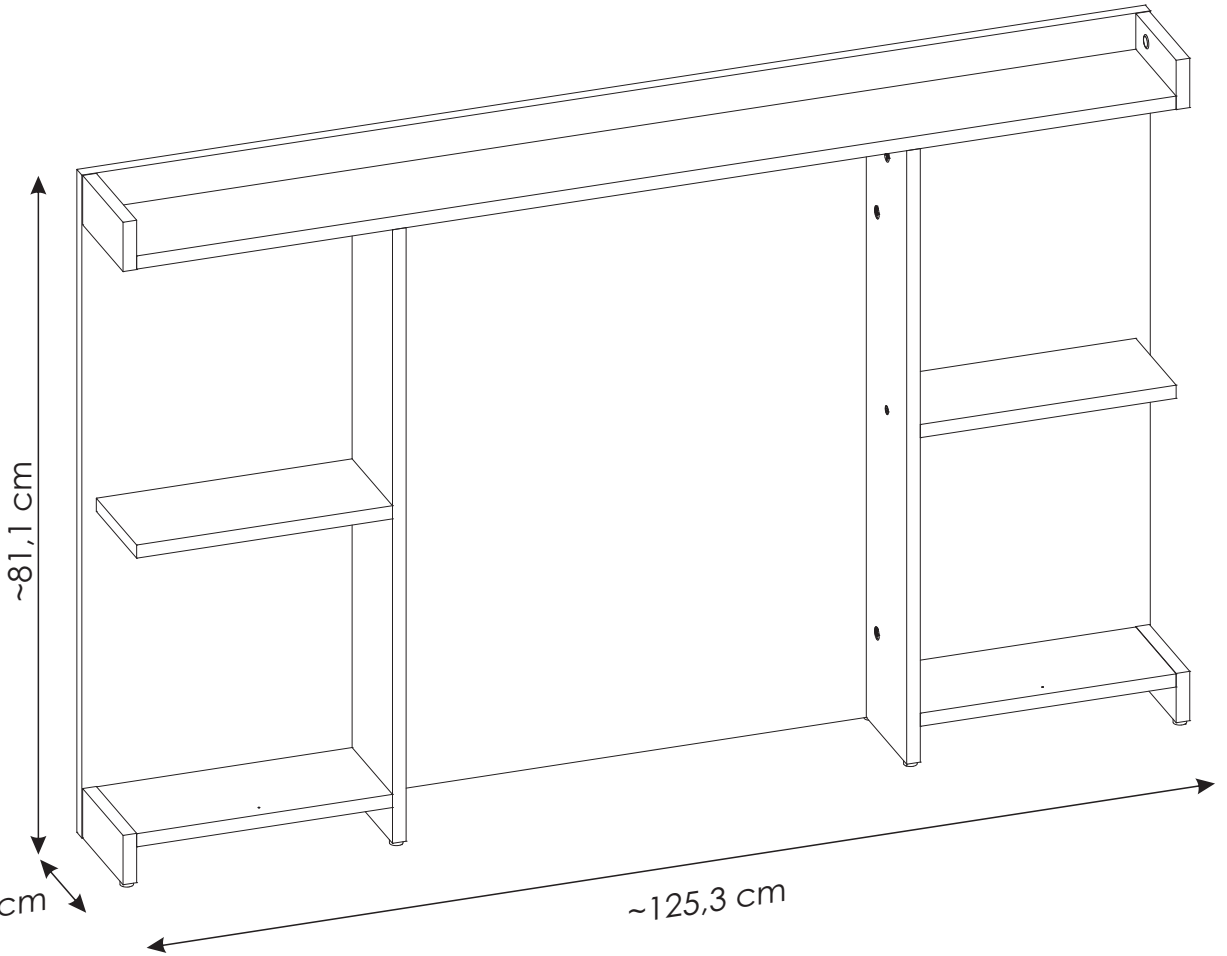
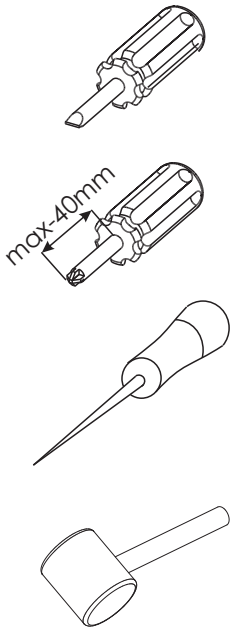
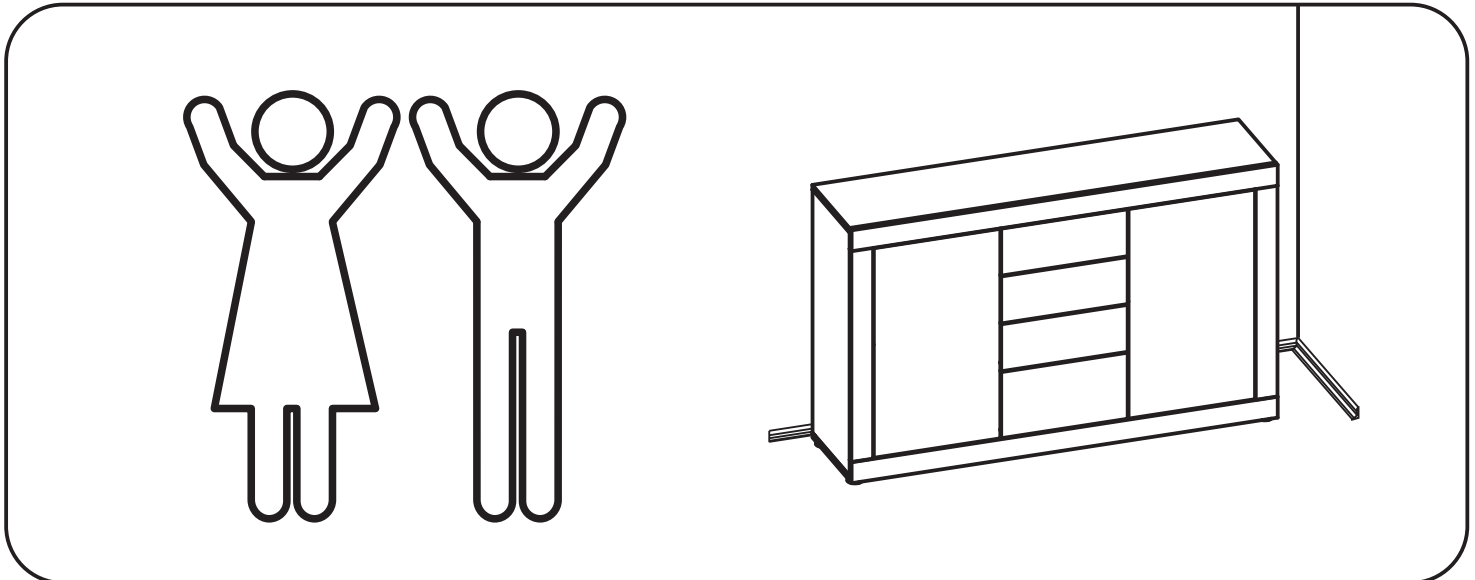
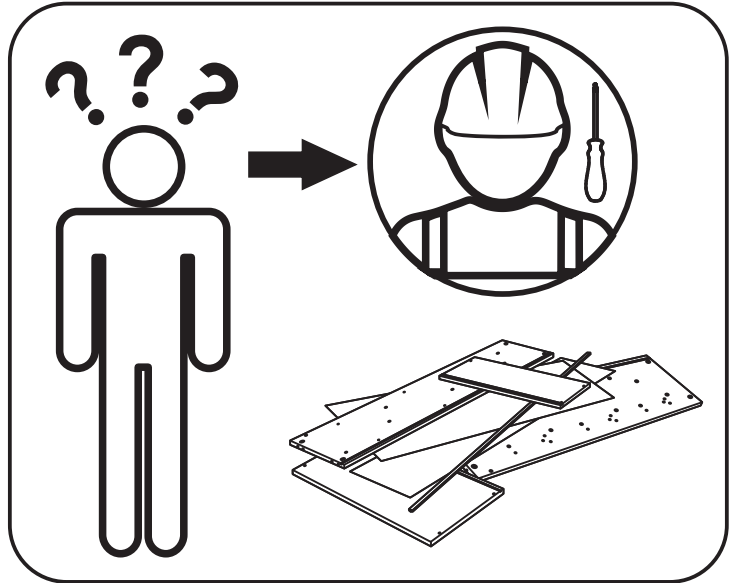
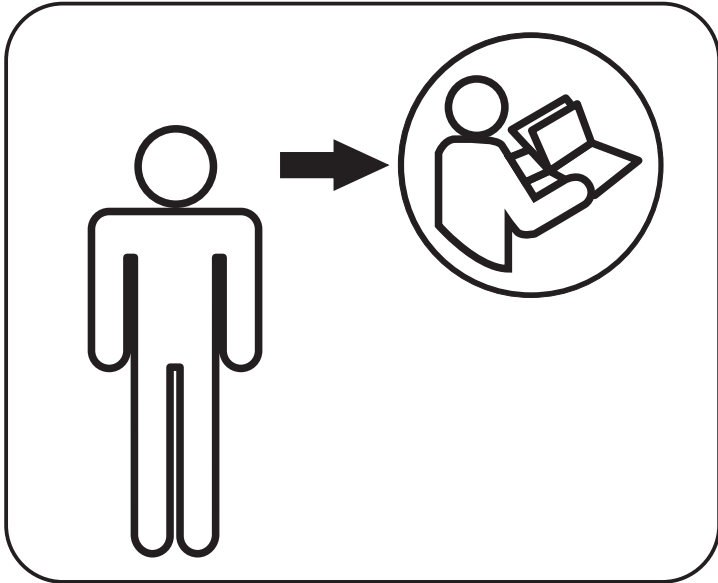
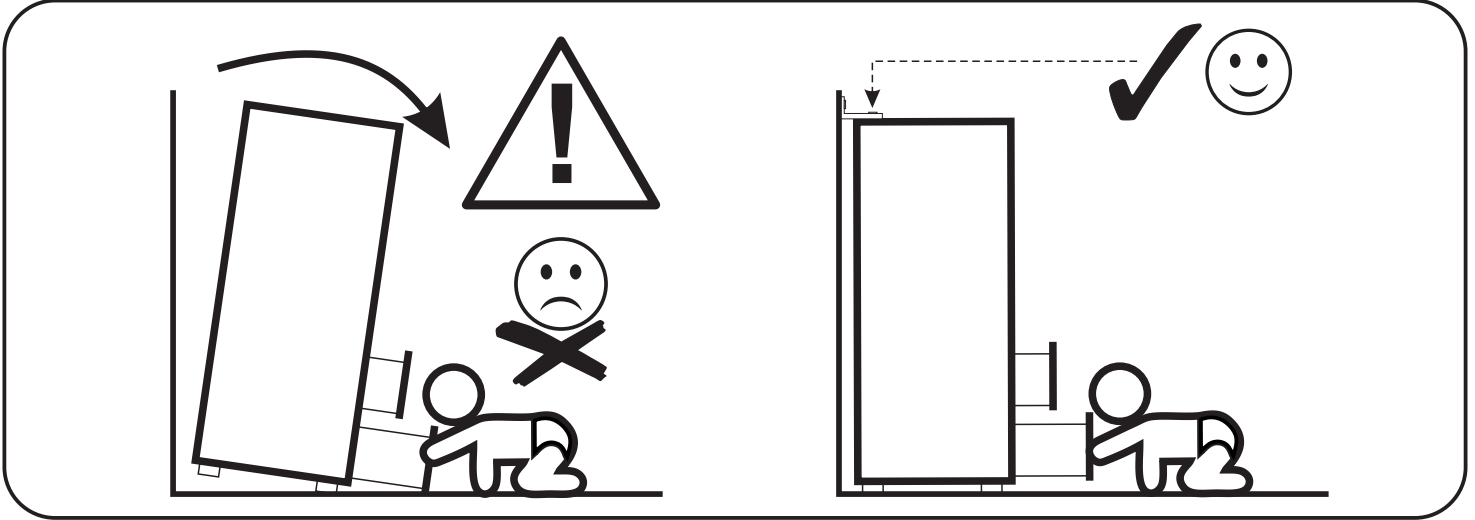
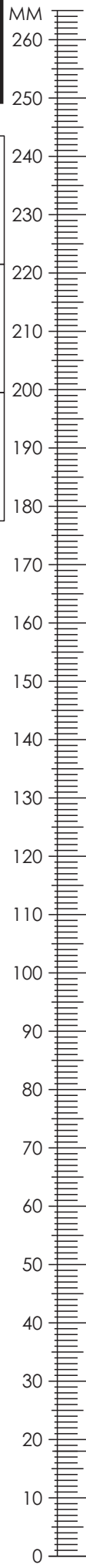

DEIZ04

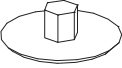

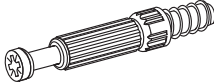

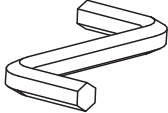
DEIZ04

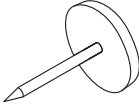

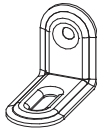
A1 8 x 35 mm x36 	E0 Ø16 x4 	E1 15 x 12 mm x22 
F1 6 x 34 mm x22 	G2 7 x 60 mm x2 	M x1 
N5 3,5 x 16 mm x8 	O2 x8 	P17 x4 
Q8 x4 		

DEIZ04

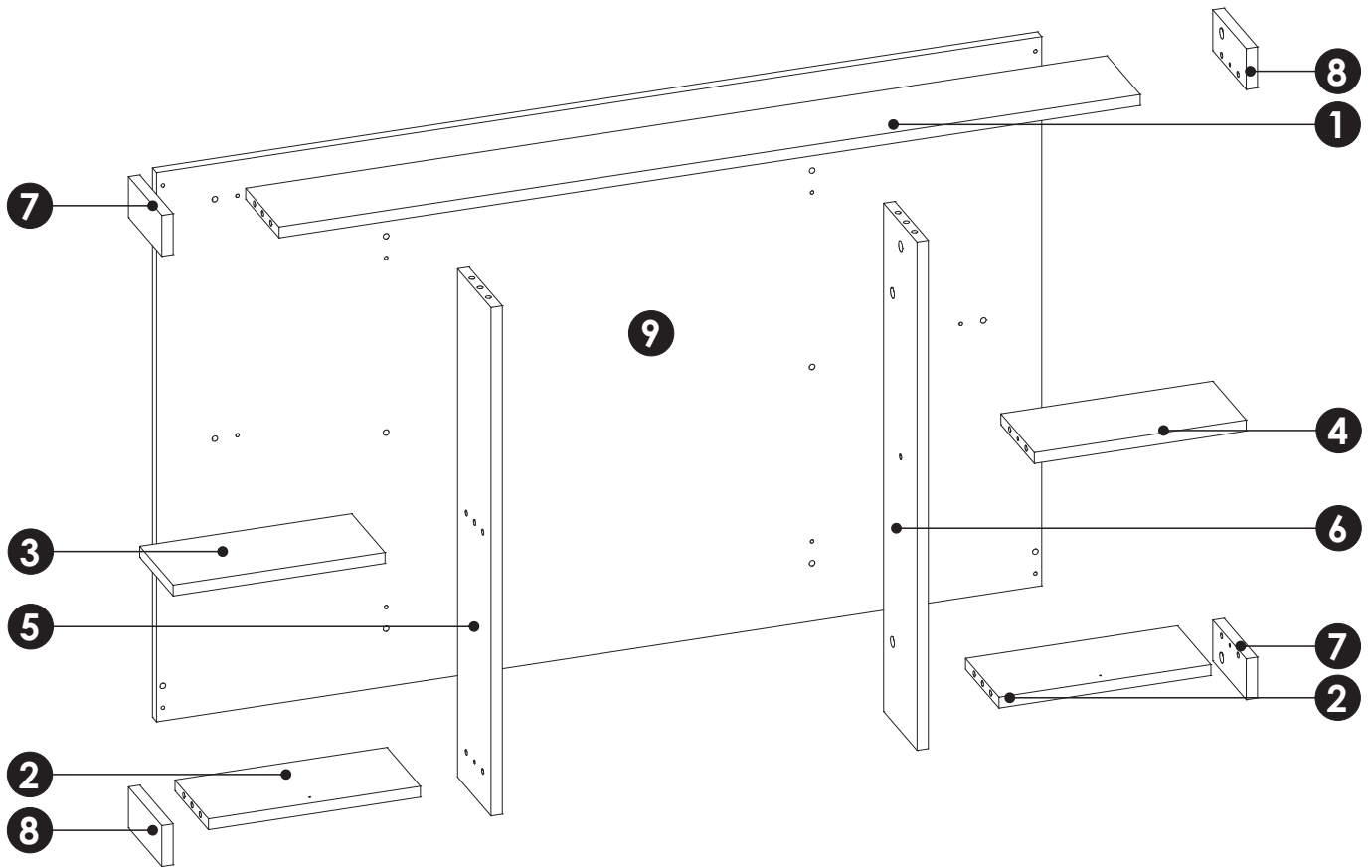
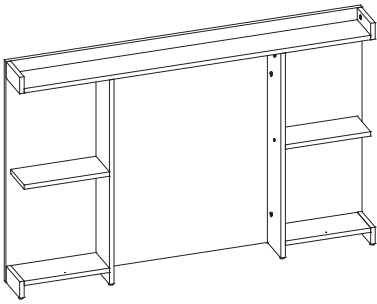

1	1219	130	16	x1	1/1
2	300	130	16	x2	1/1
3	300	130	16	x1	1/1
4	300	130	16	x1	1/1
5	746	130	16	x1	1/1
6	746	130	16	x1	1/1
7	130	60	16	x2	1/1
8	130	60	16	x2	1/1
9	1253	806	16	x1	1/1

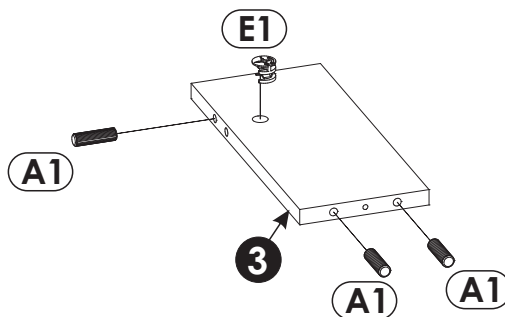
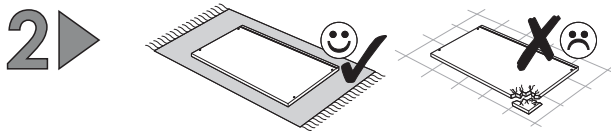
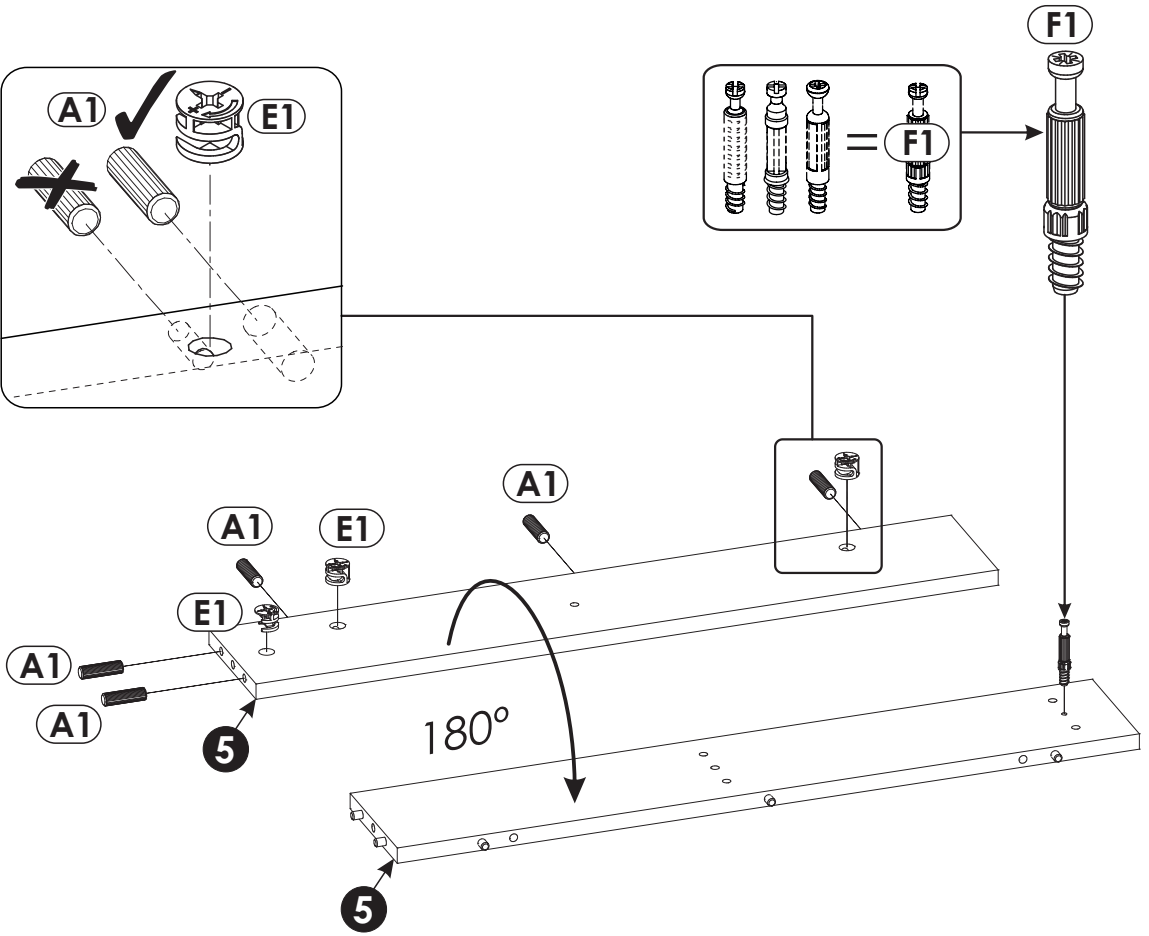
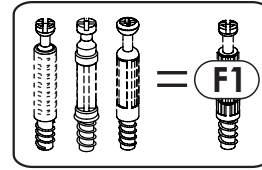
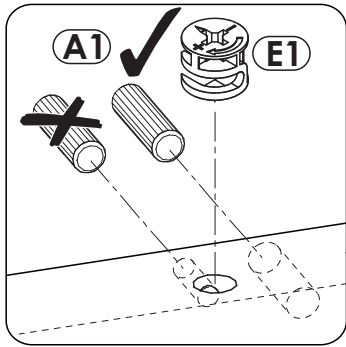
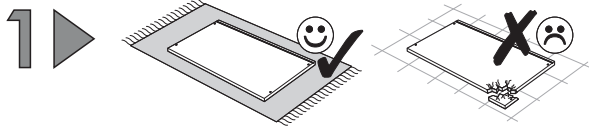
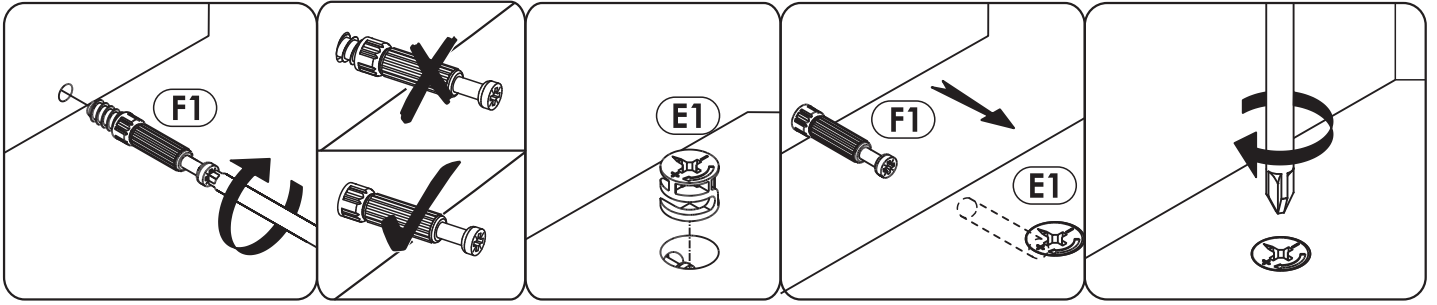

3 ▶

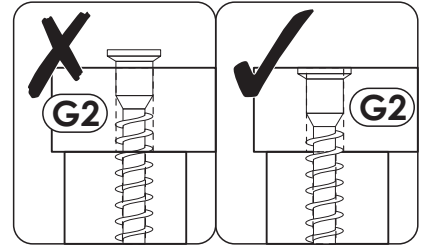
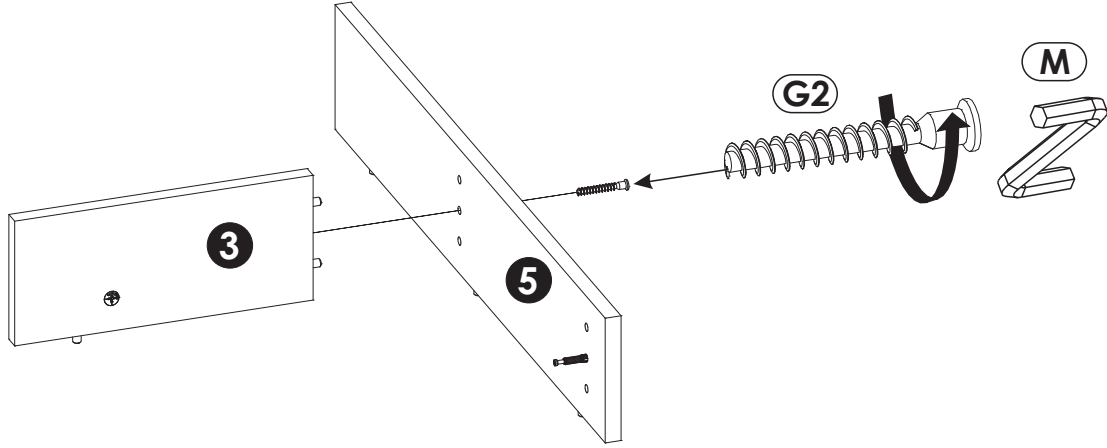
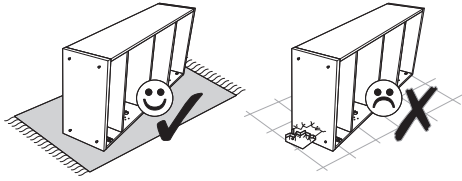

4 ▶

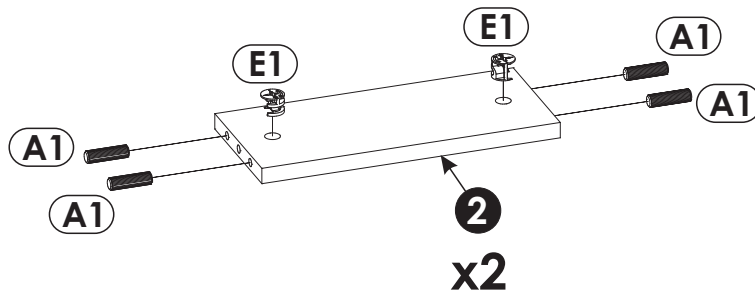
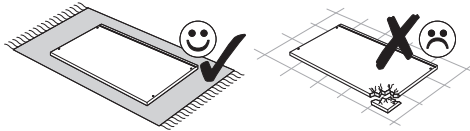

5 ▶

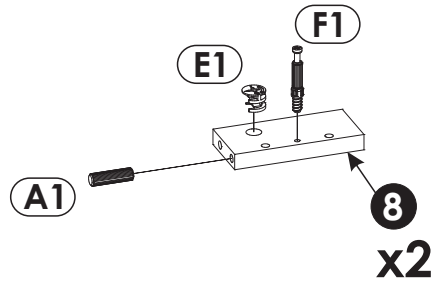
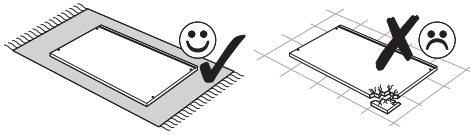

6 ▶

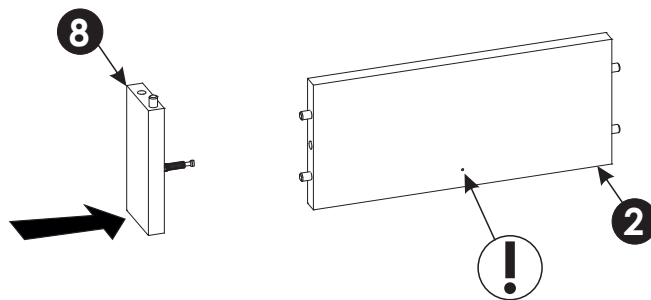
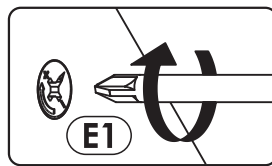
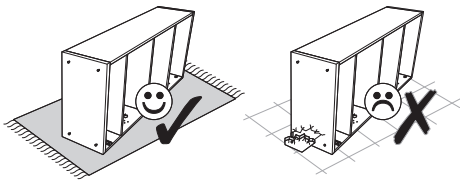

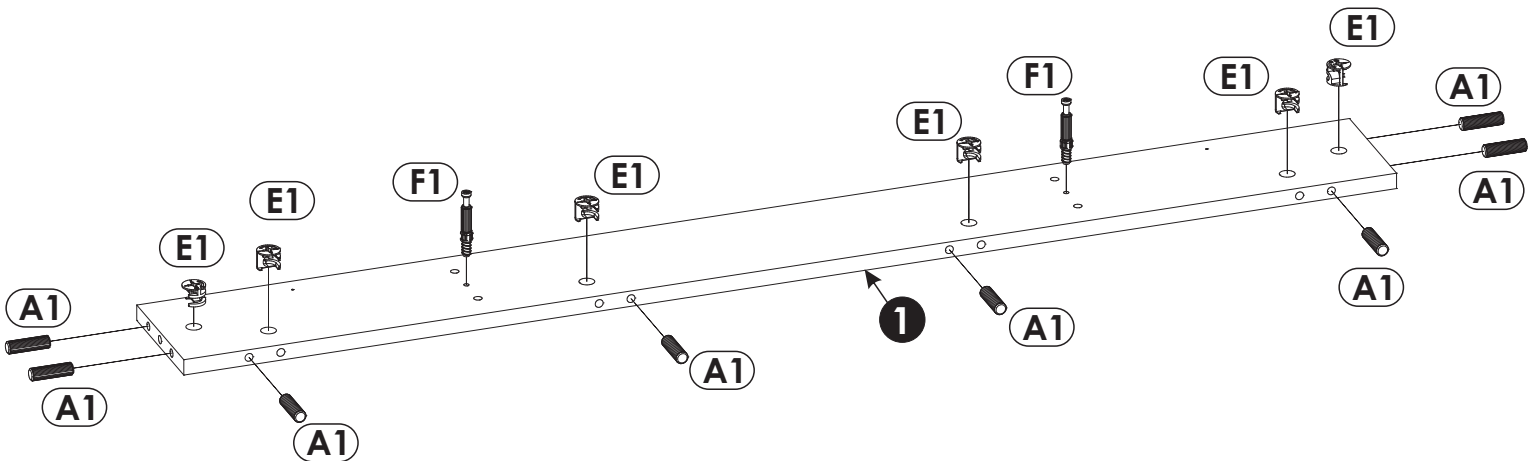
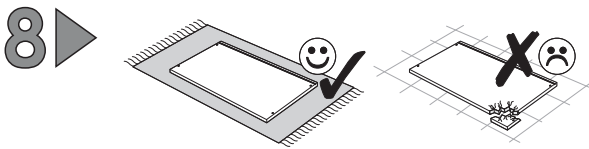
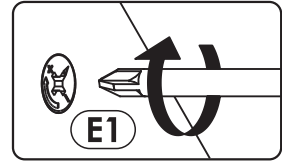
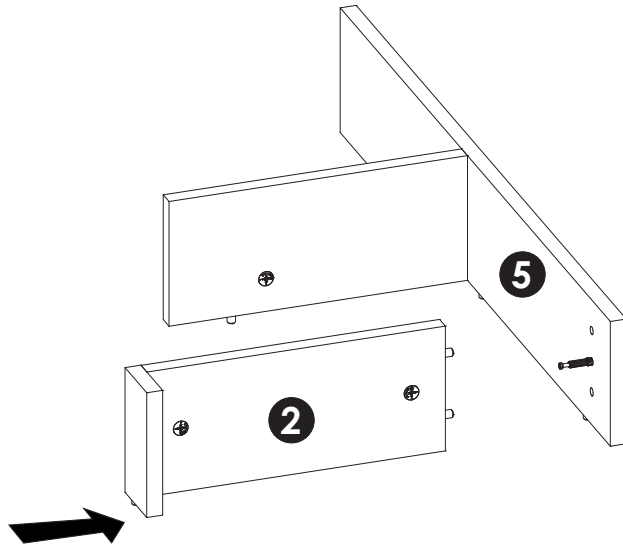
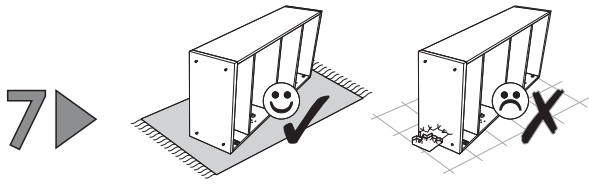

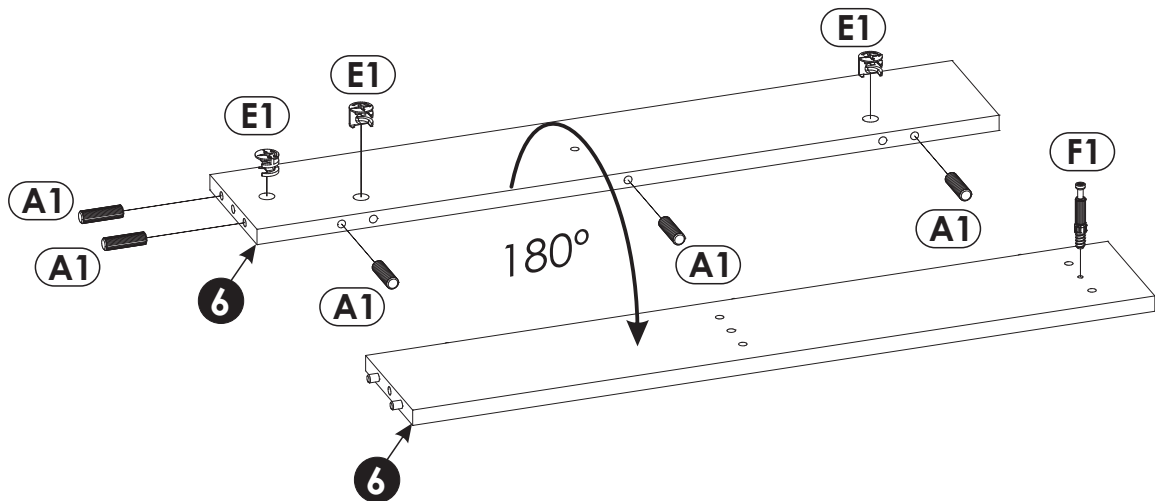
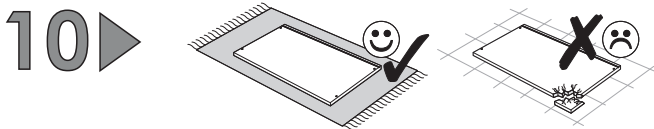
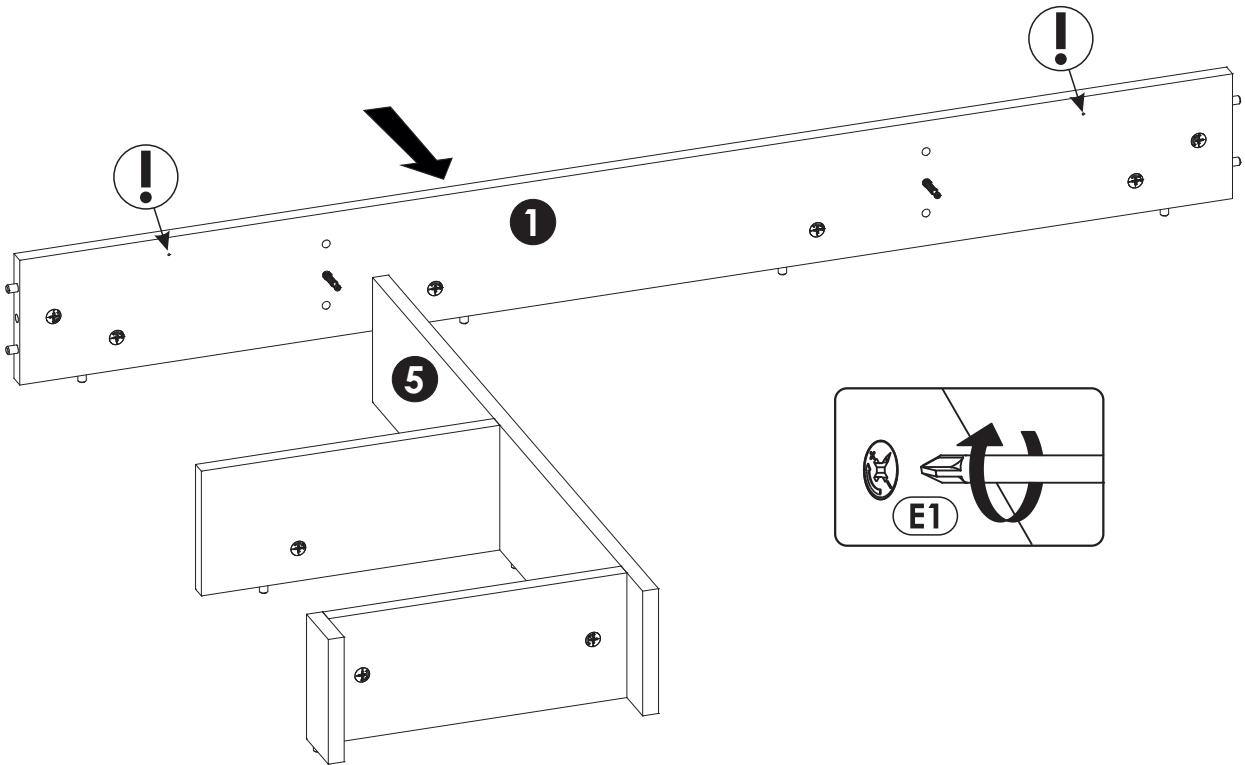
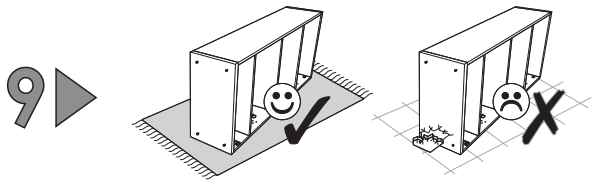

11 ▶

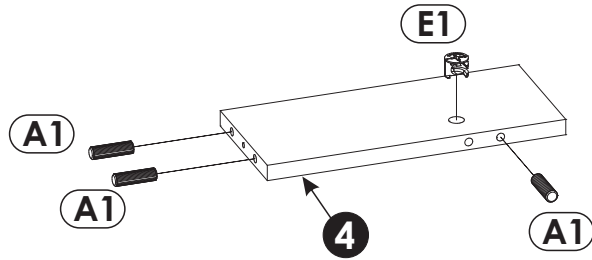
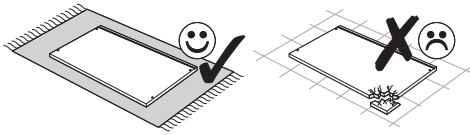

12 ▶

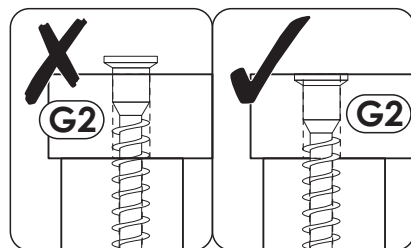
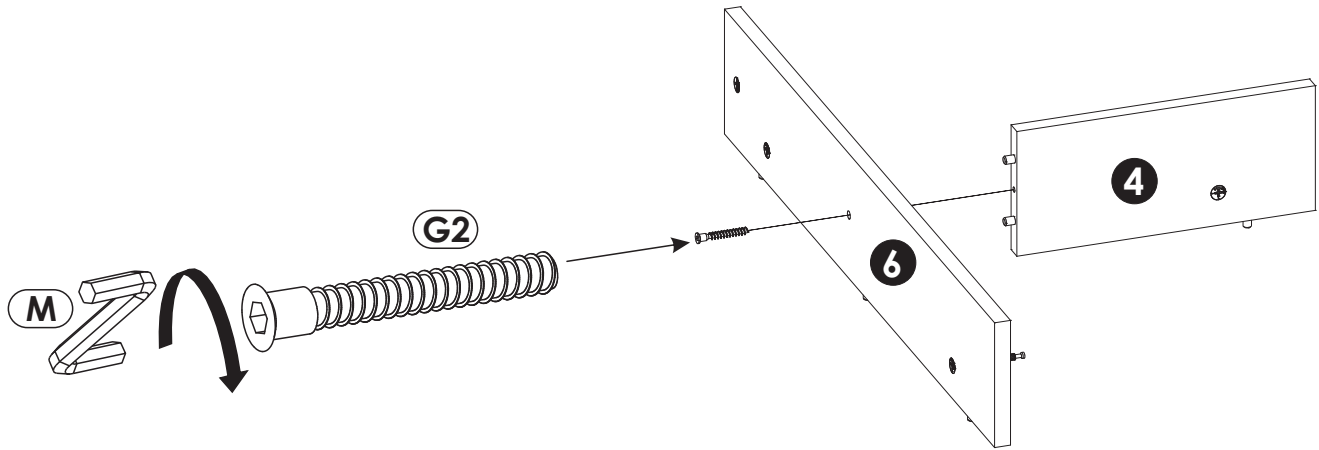
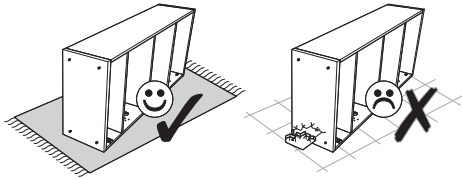

13▶

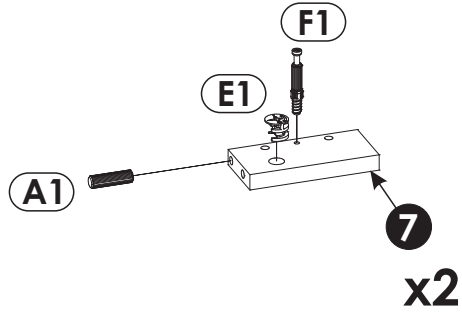
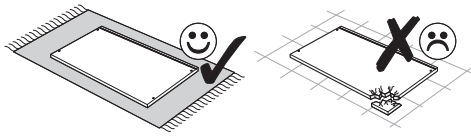

14▶

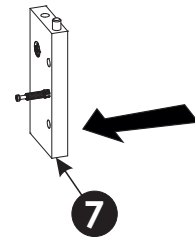
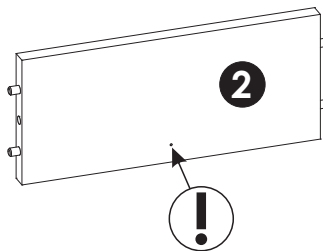
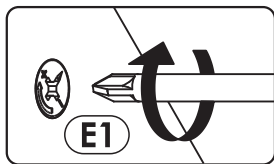
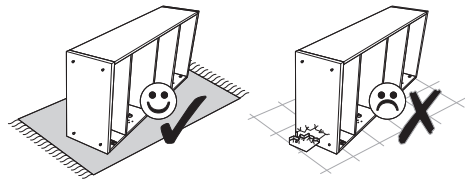

15 ▶

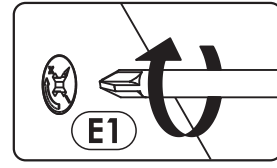
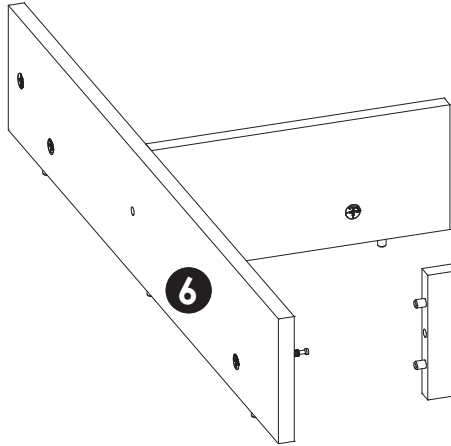
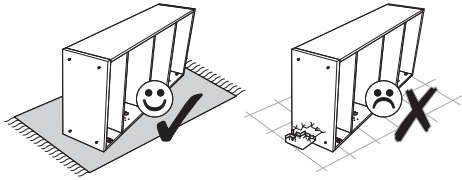

16 ▶

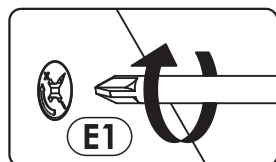
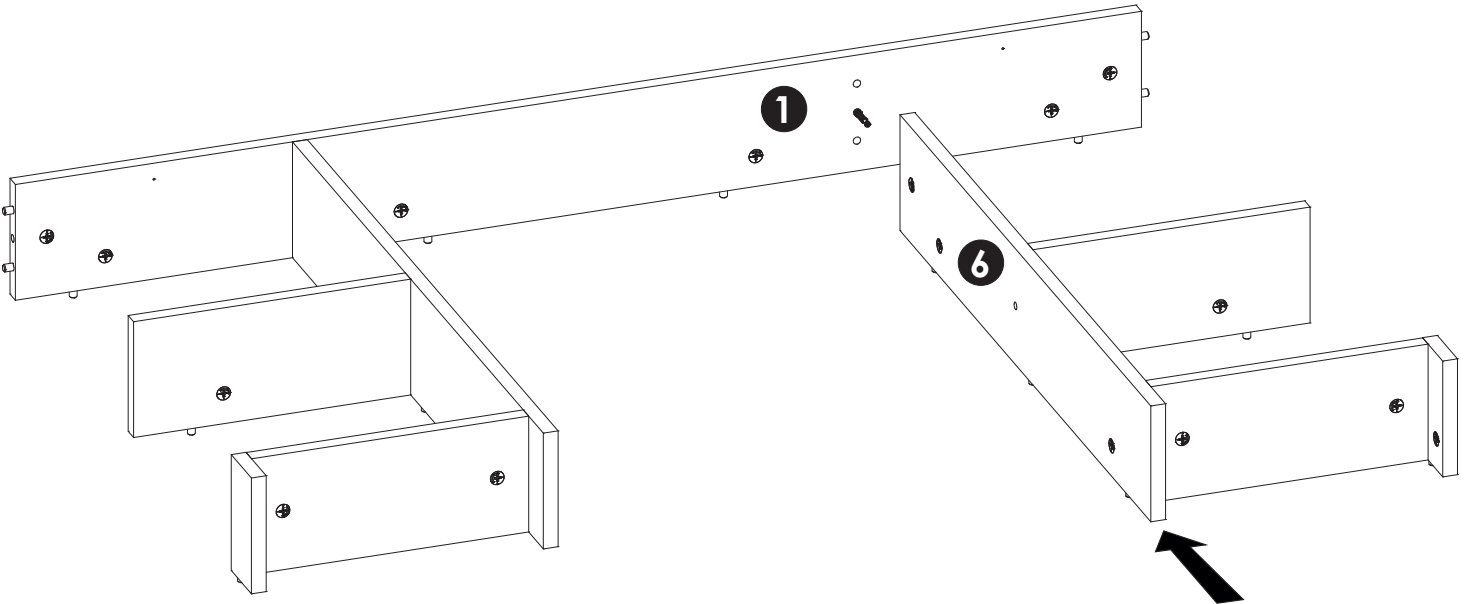
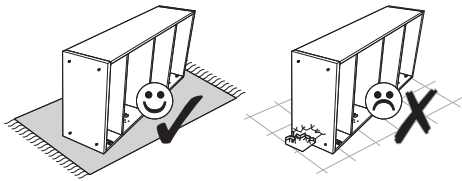

17 ▶

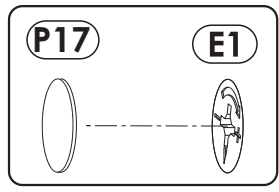
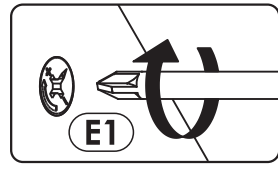
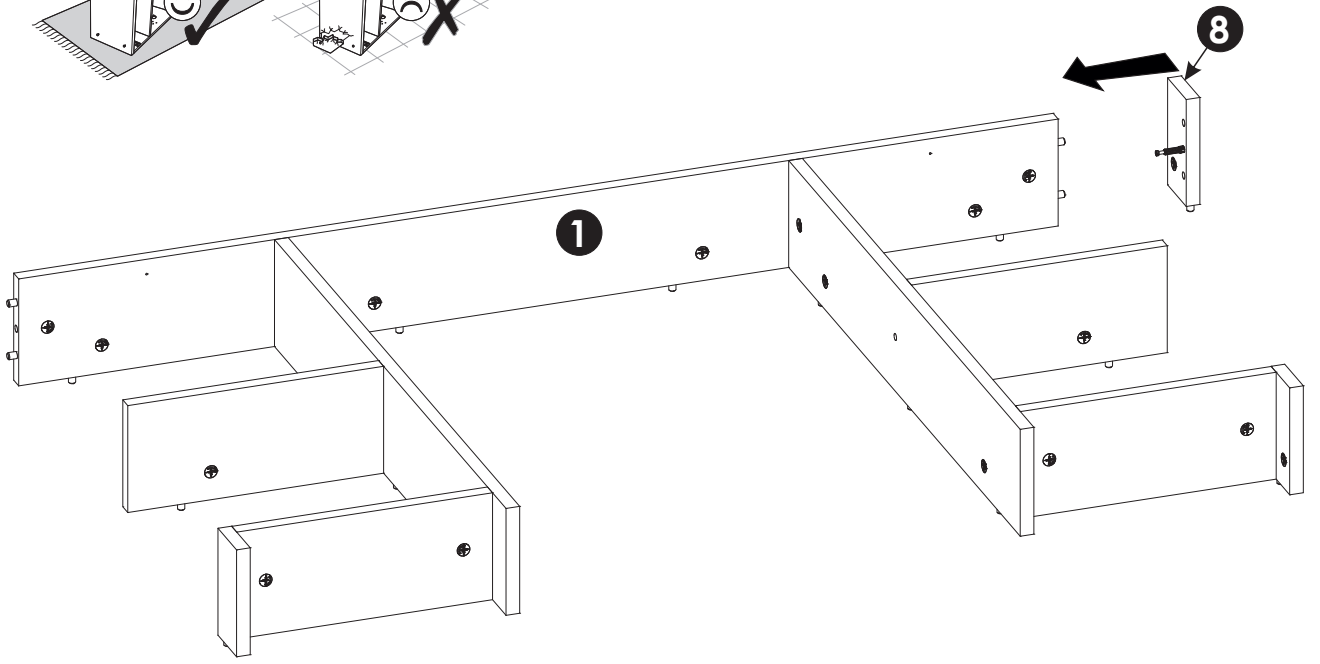
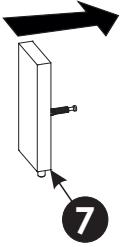
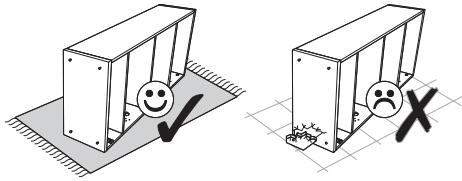

18 ▶

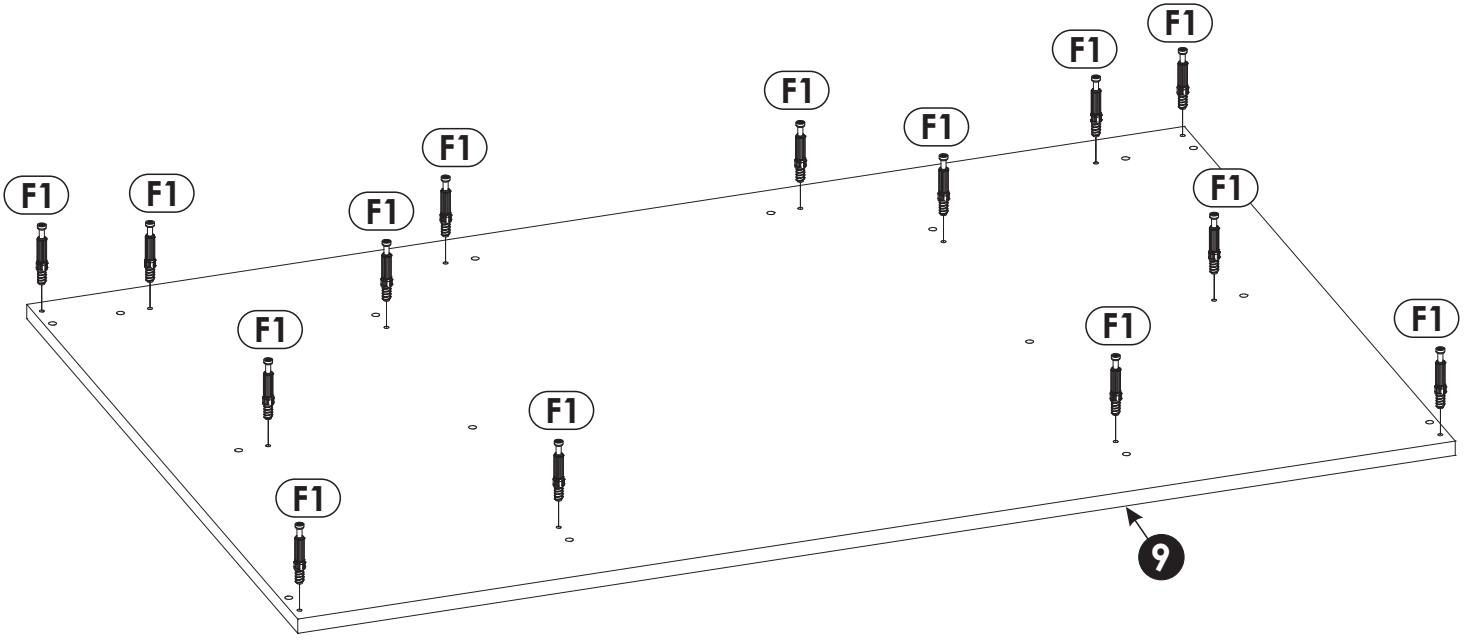
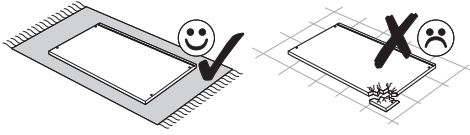

19 ▶

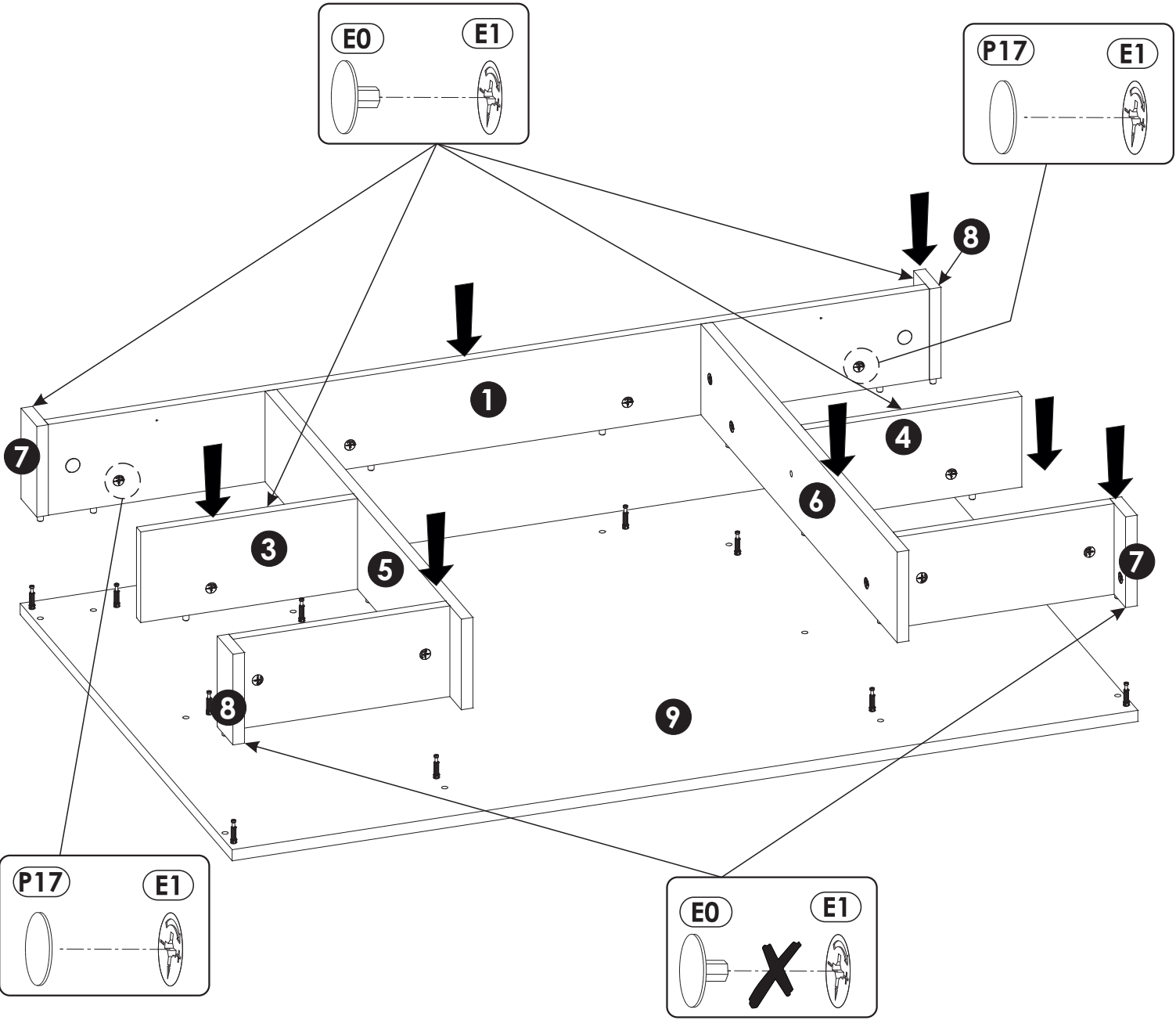
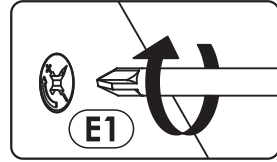
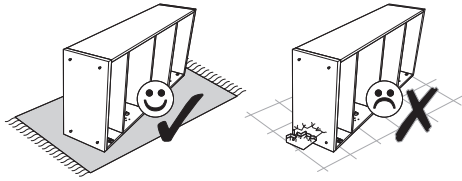

20 ▶

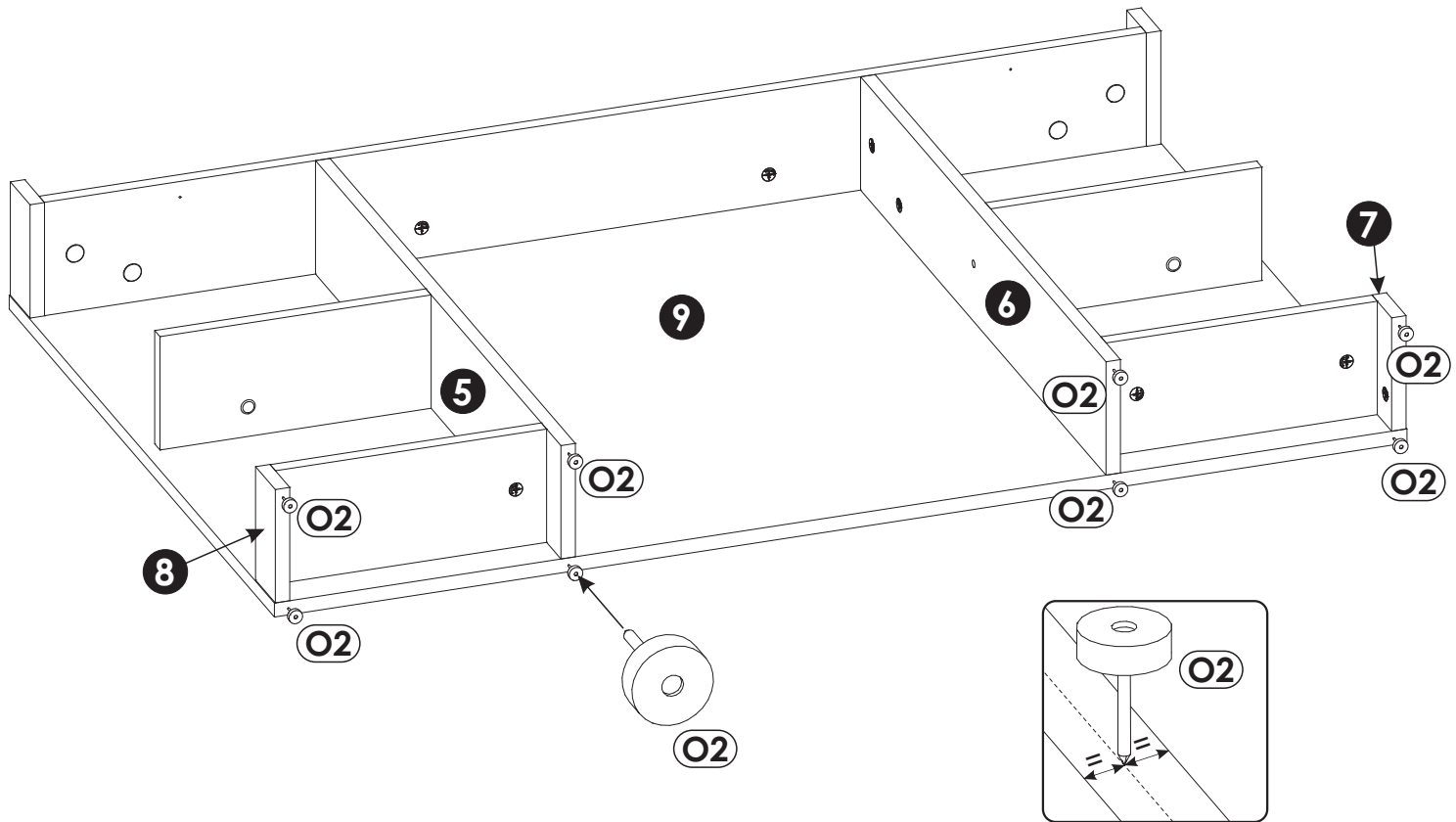
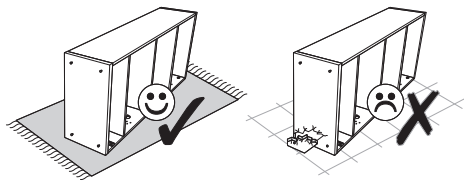

DEIZ04

+

DEIZ02

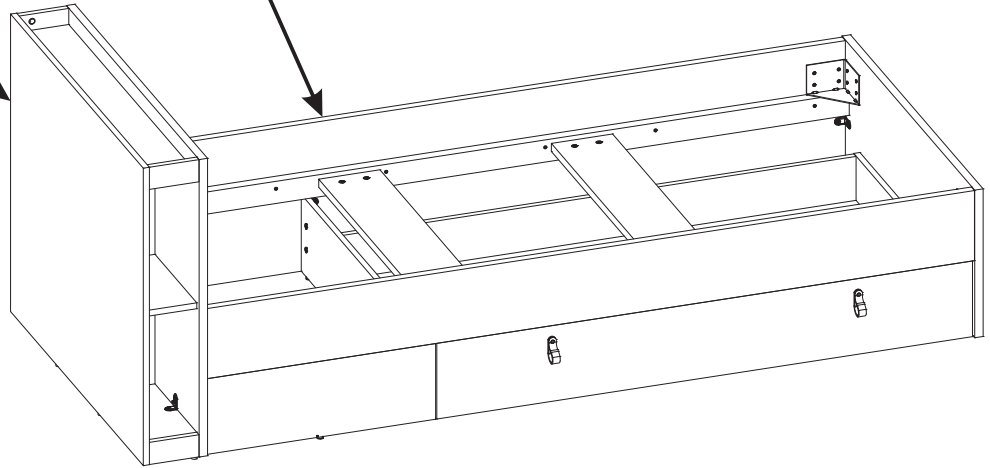

21 ▶

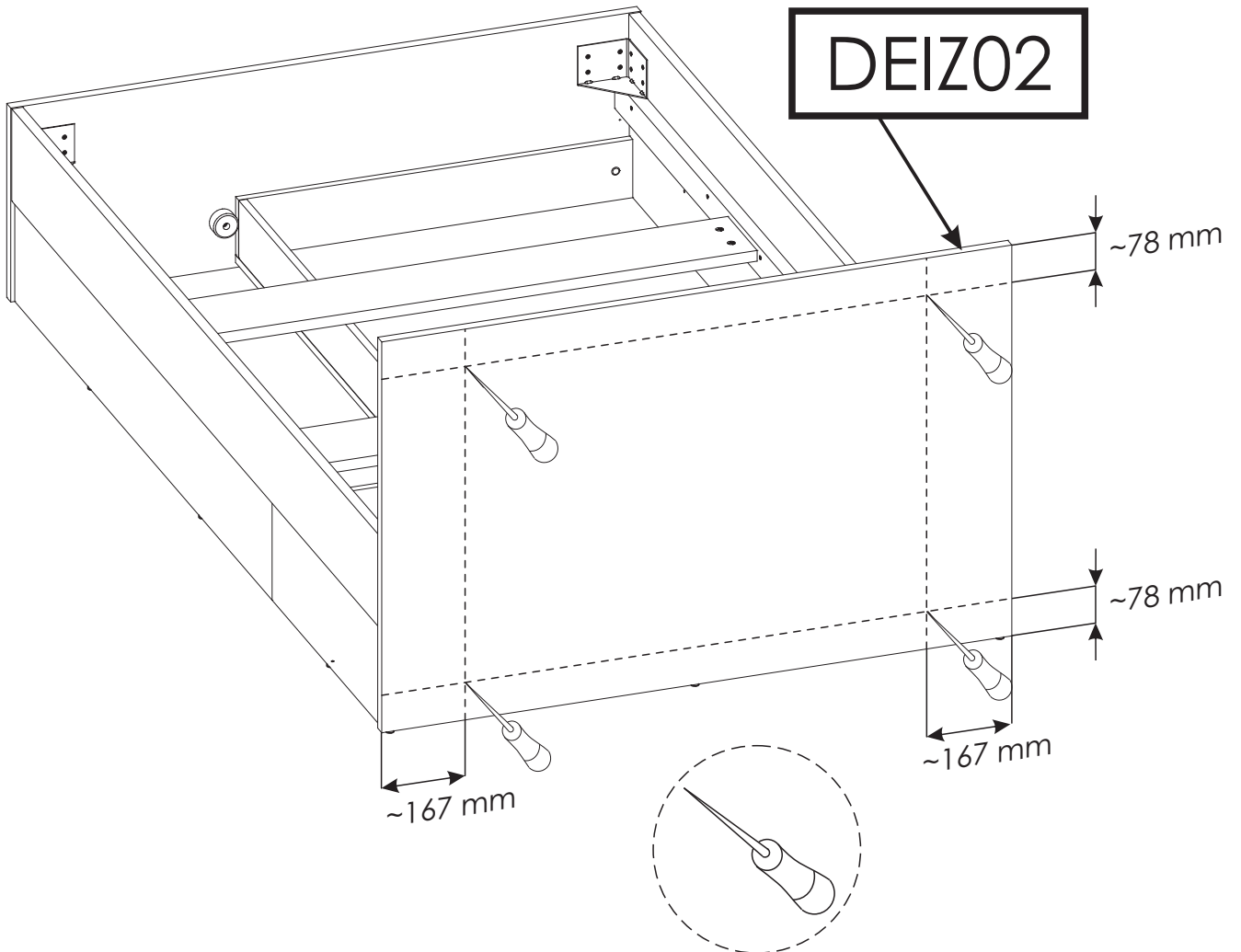

22 ▶

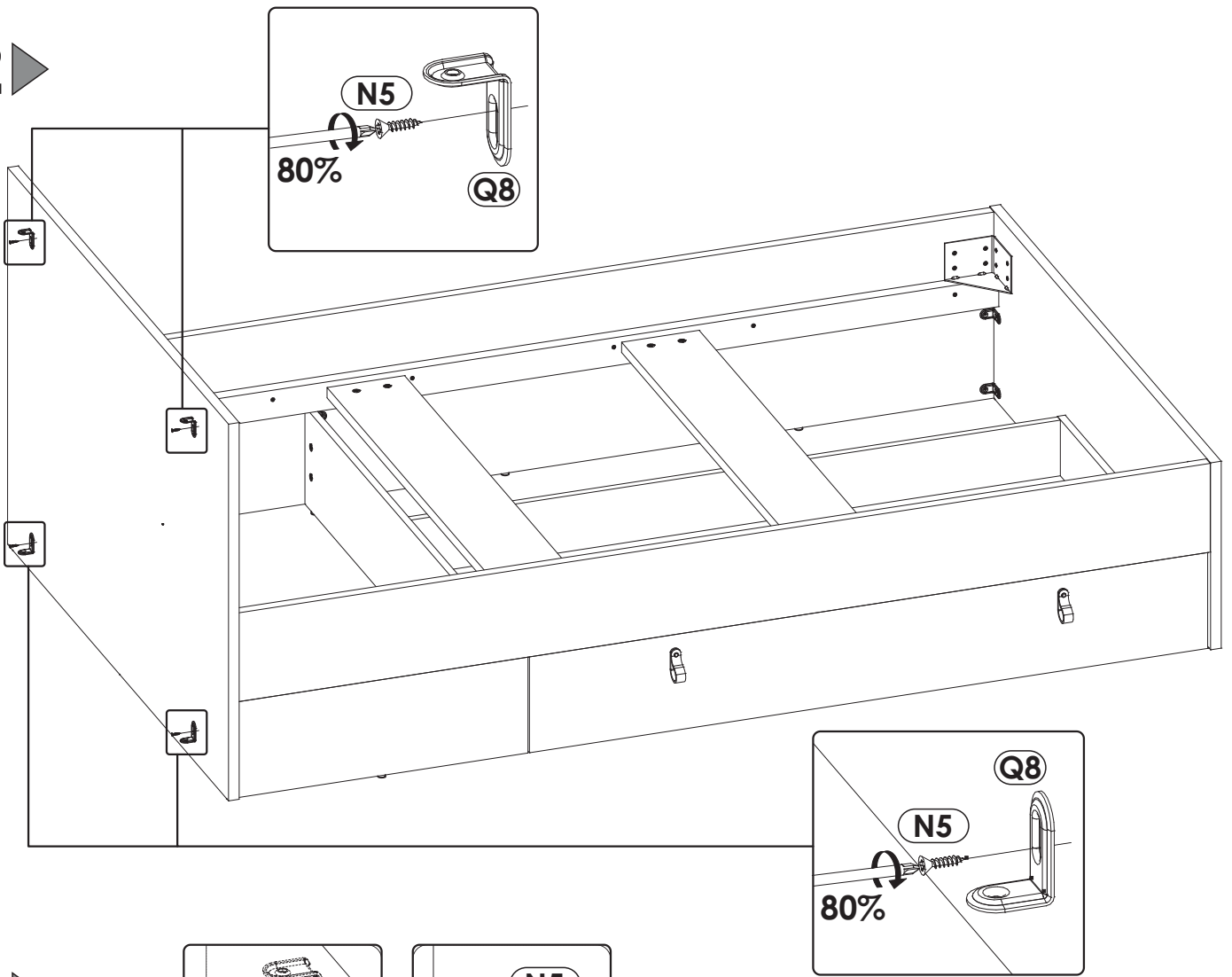

23 ▶

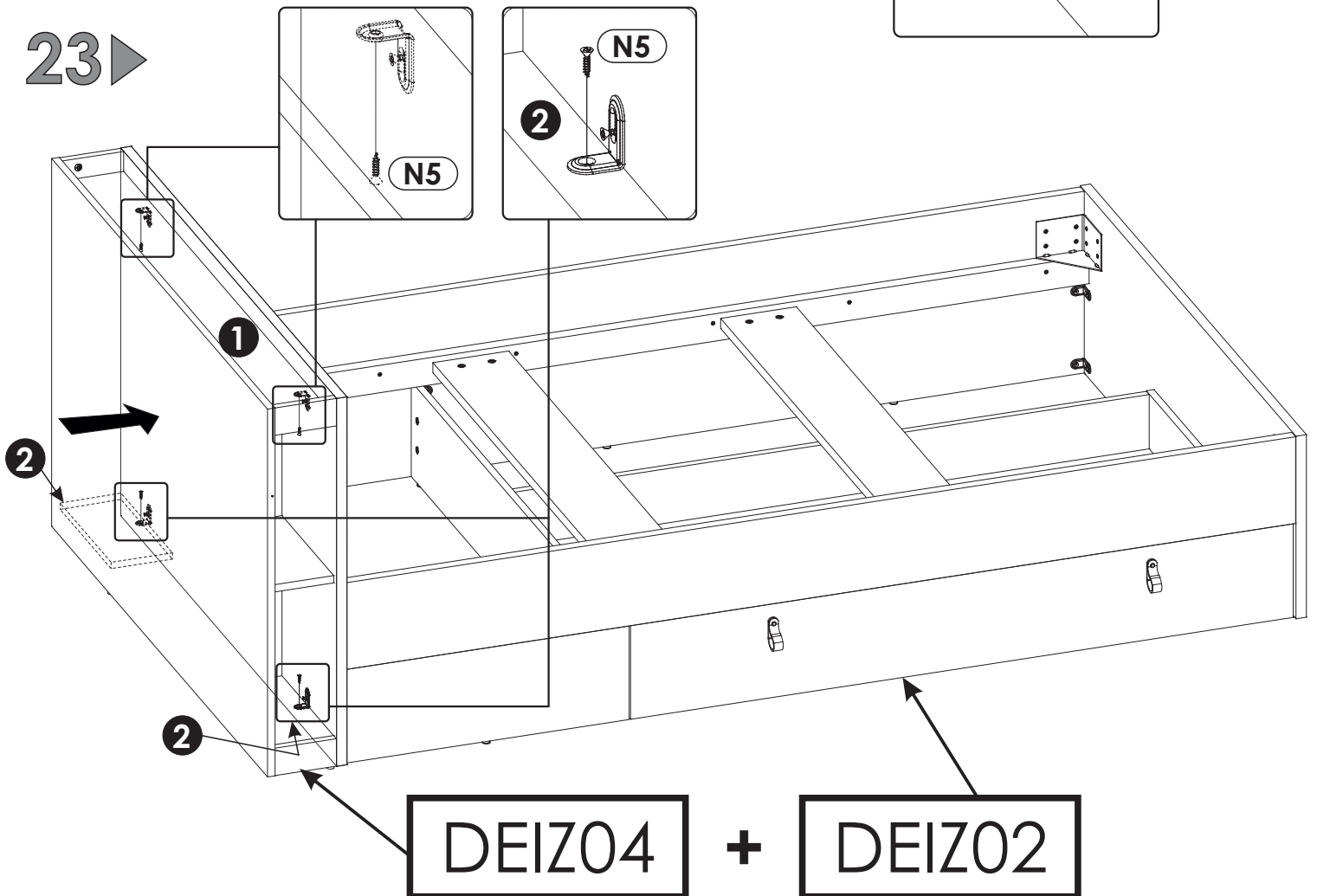

24 ▶

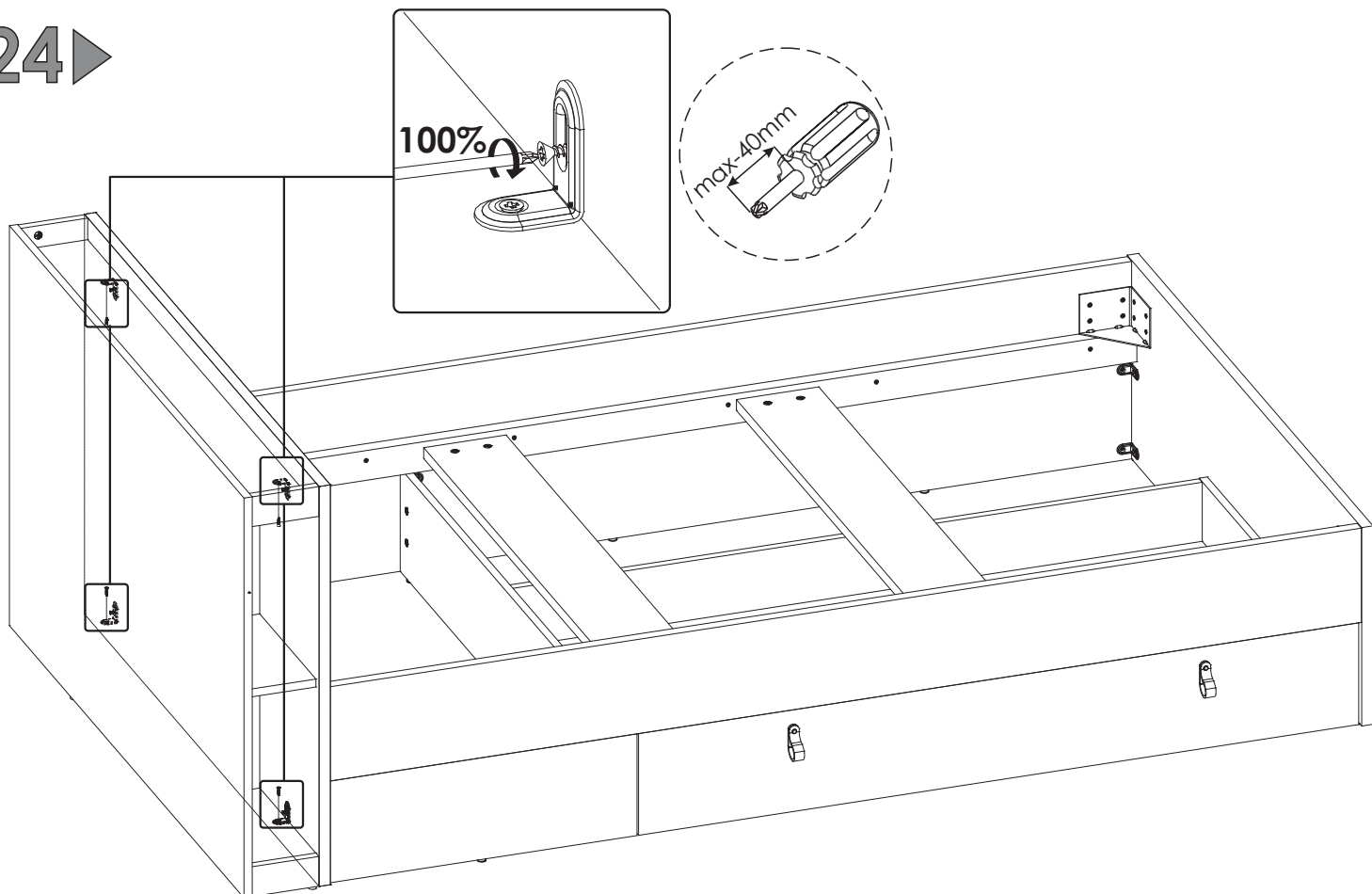

25 ▶

