

**A****S228-P/3/20****10 90 CC 40**

2 / 5

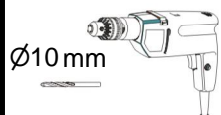

Ø10 mm

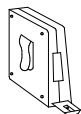
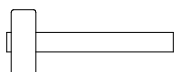
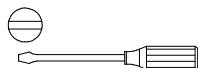
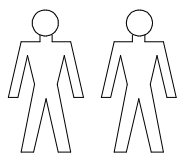
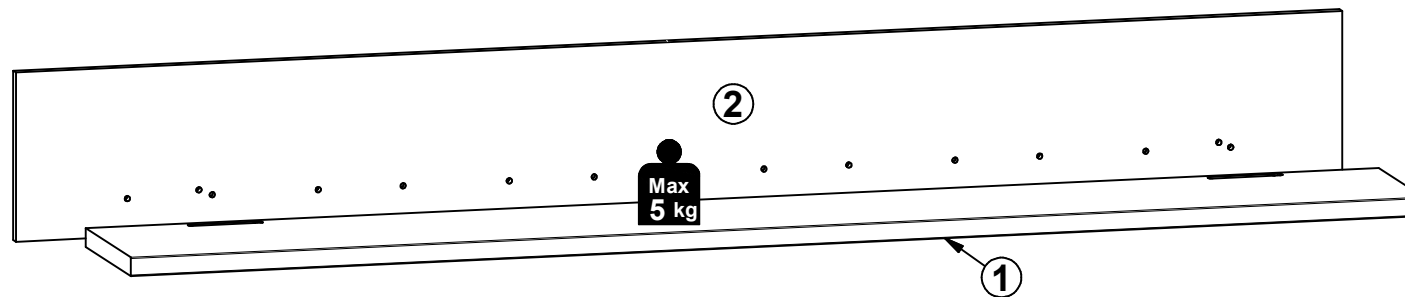

A	B	C (mm)		D
1	S228-321	1950	254	1/1
2	S228-406	2000	250	1/1

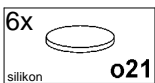
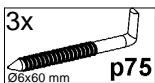
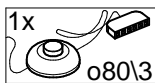
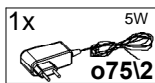
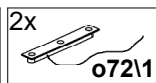
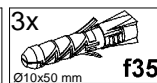
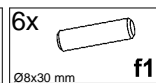
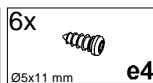
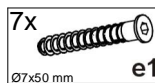
**30 min**

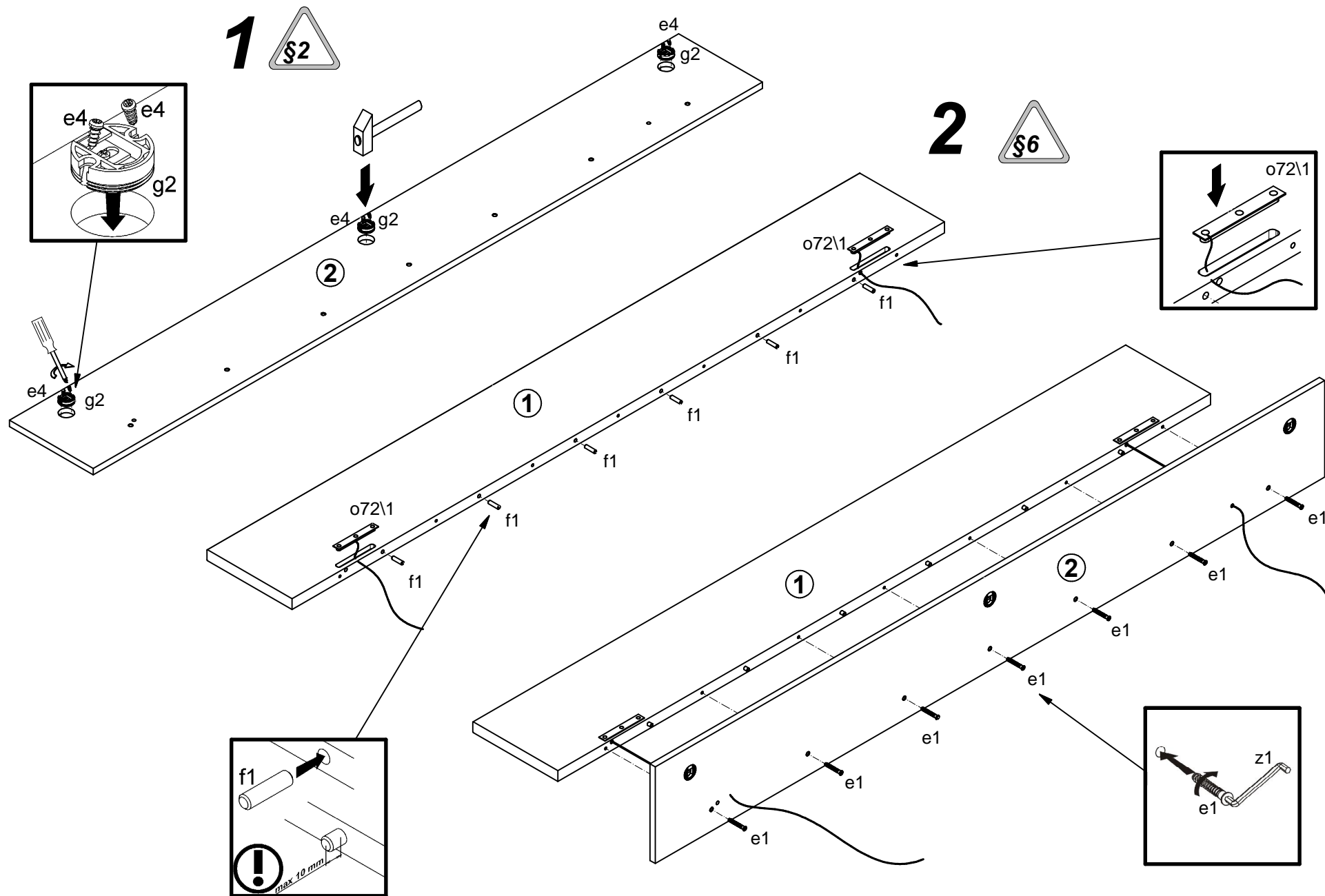

3

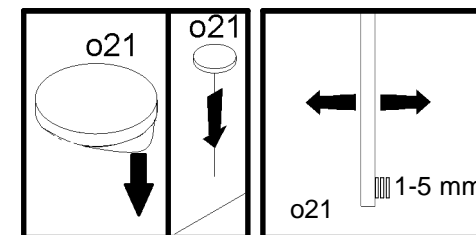
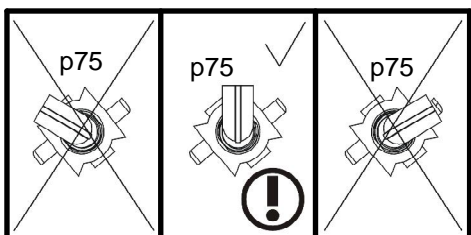
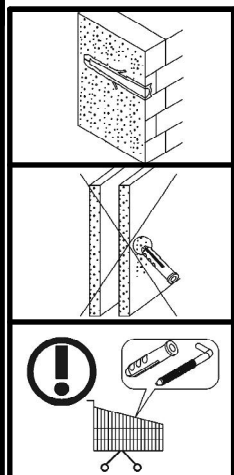
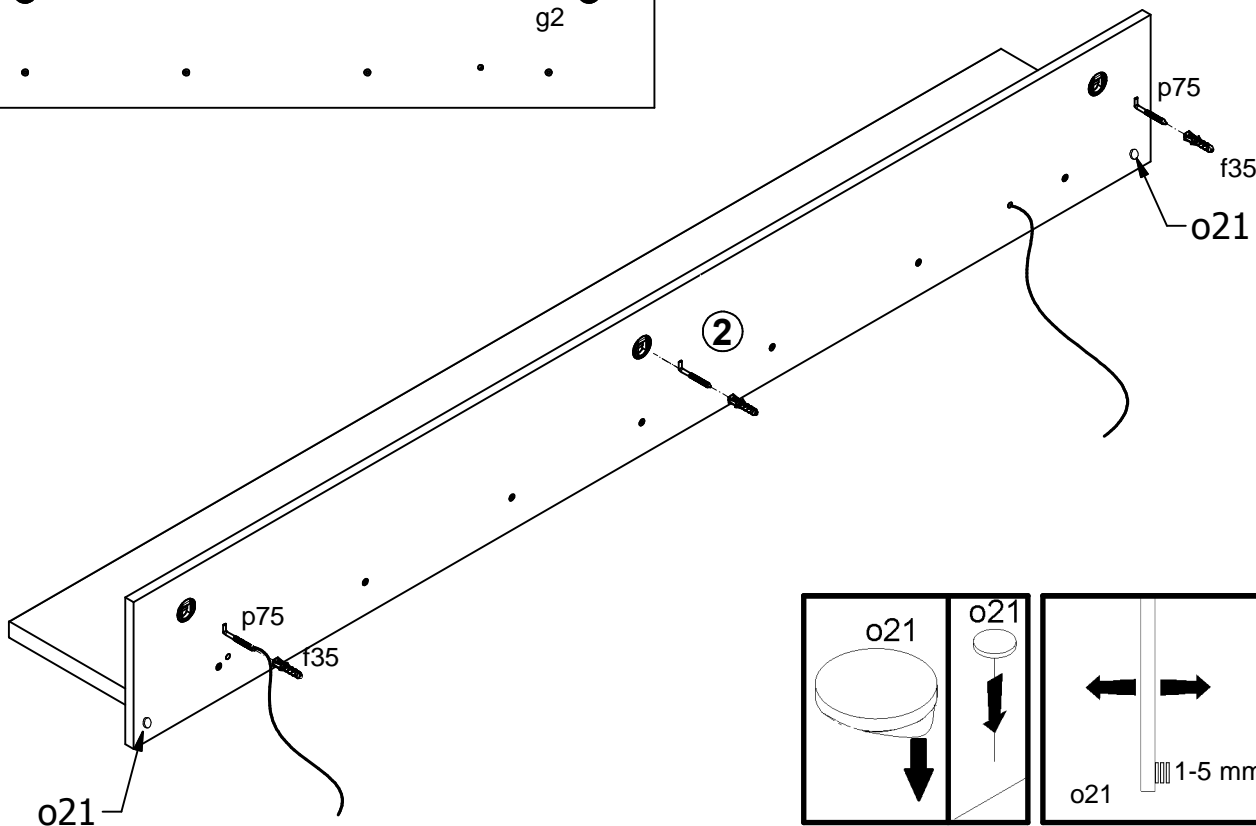
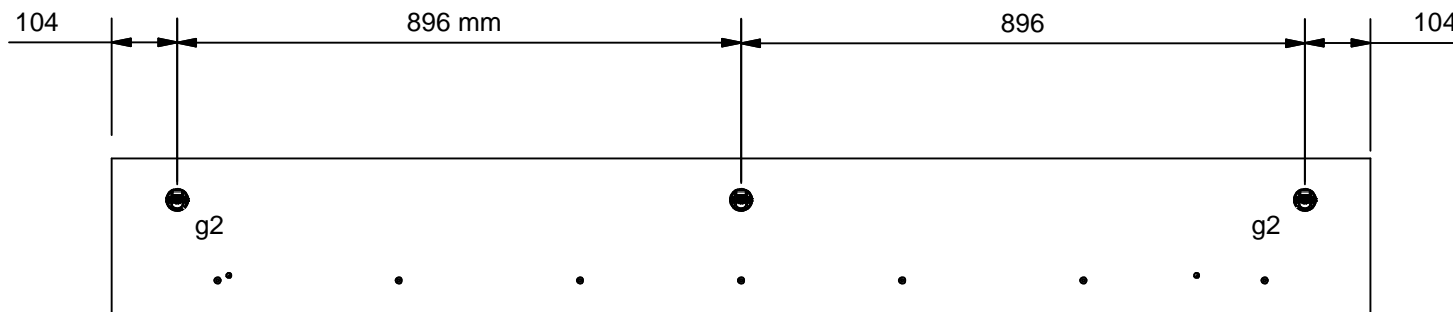
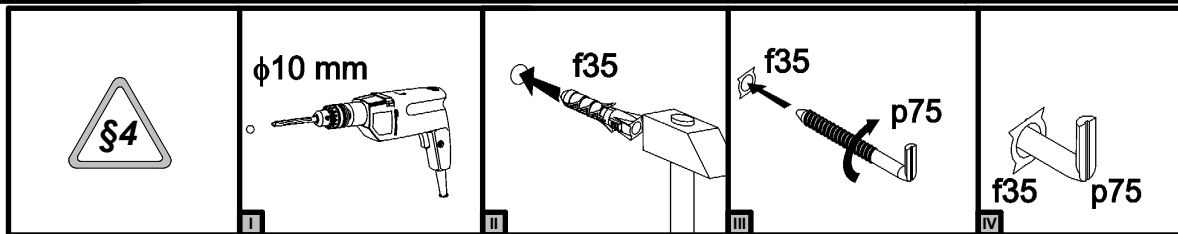

4

