

A  
x16



G  
x3



LA  
x4



B  
x16



H  
x1



LB  
x4



C  
x50  
20mm



I  
x20  
16mm



LC  
x2



D  
x30



J  
x4



E  
x4  
30mm



K

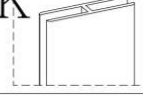

F  
x2



L  
x1

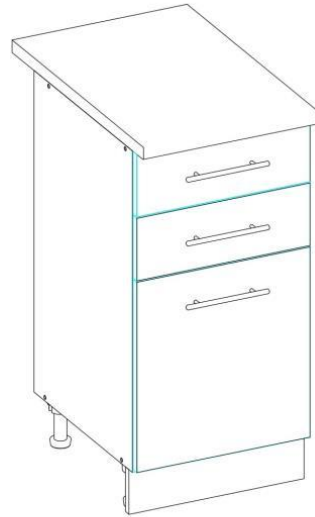
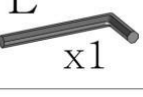

Montážny návod		1/1
D40SZ_	Je potrebné použiť kladivo a šraubovák.	
Promo	Skrinky montujte podľa krokov v montážnom návode.	
260cm		

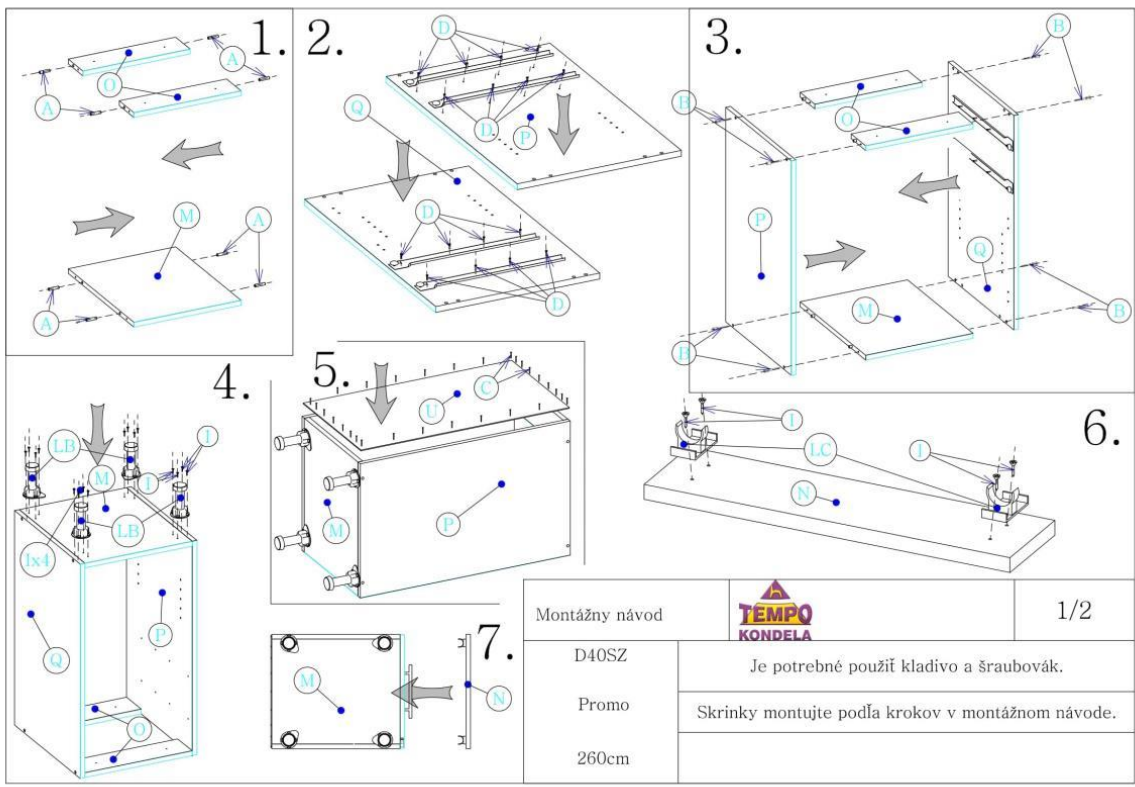

Montážny návod		1/2
D40SZ	Je potrebné použiť kladivo a šraubovák.	
Promo	Skrinky montujte podľa krokov v montážnom návode.	
260cm		

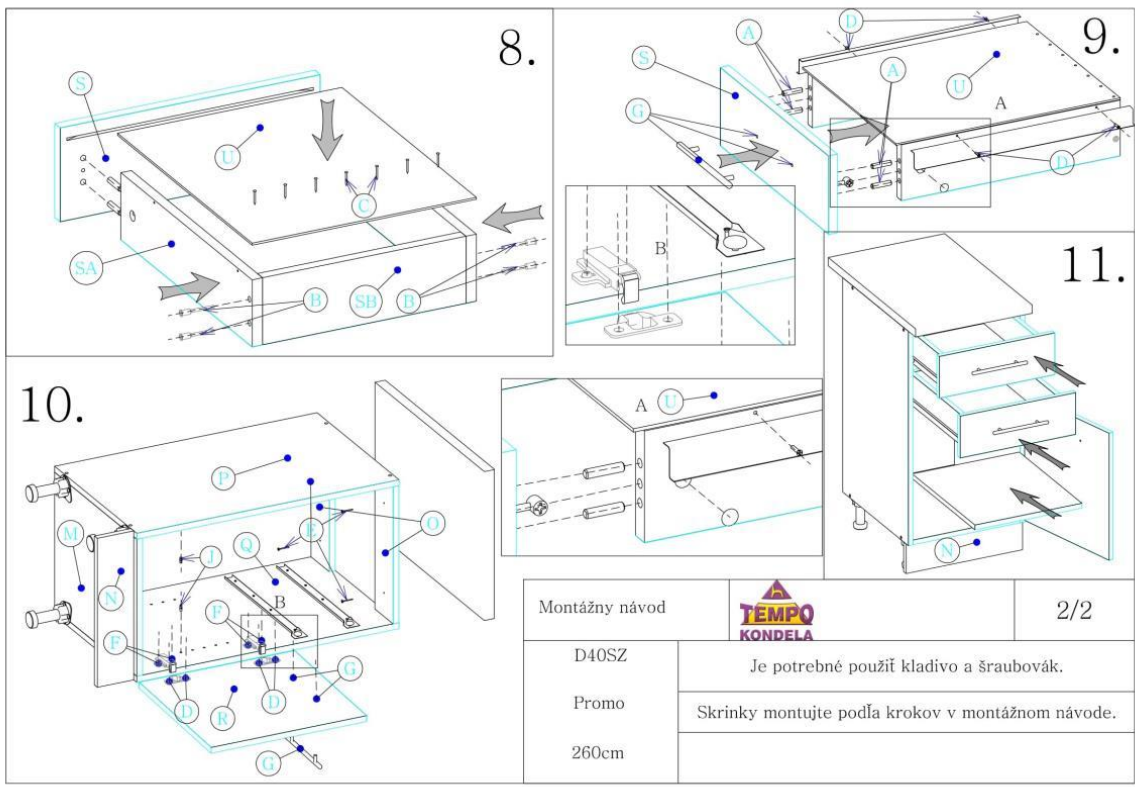

Montážny návod		2/2
D40SZ	Je potrebné použiť kladivo a šraubvák.	
Promo	Skrinky montujte podľa krokov v montážnom návode.	
260cm		

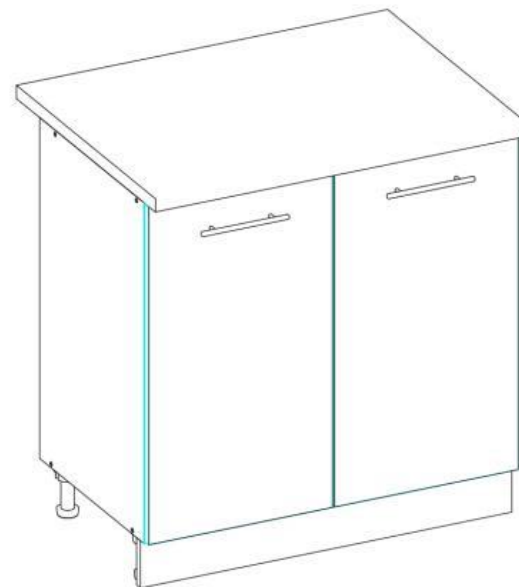
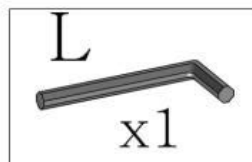
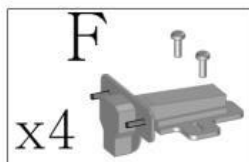
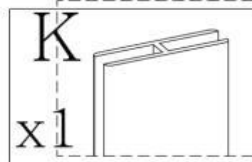
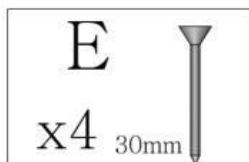
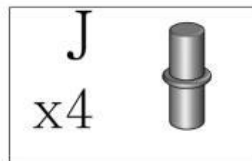
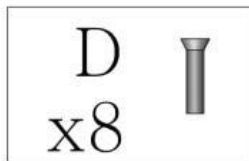
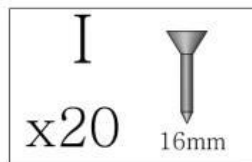
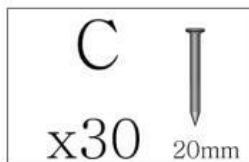
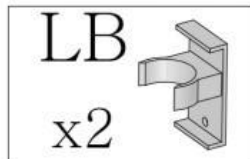
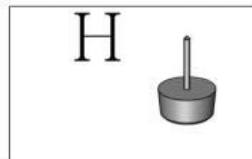
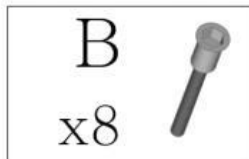
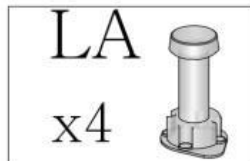
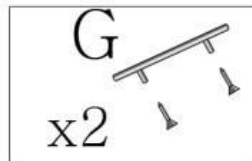
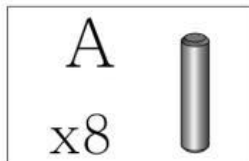

Montážny návod		1/1
D80_	Je potrebné použiť kladivo a šraubovák.	
Promo	Skrinky montujte podľa krokov v montážnom návode.	
260cm		

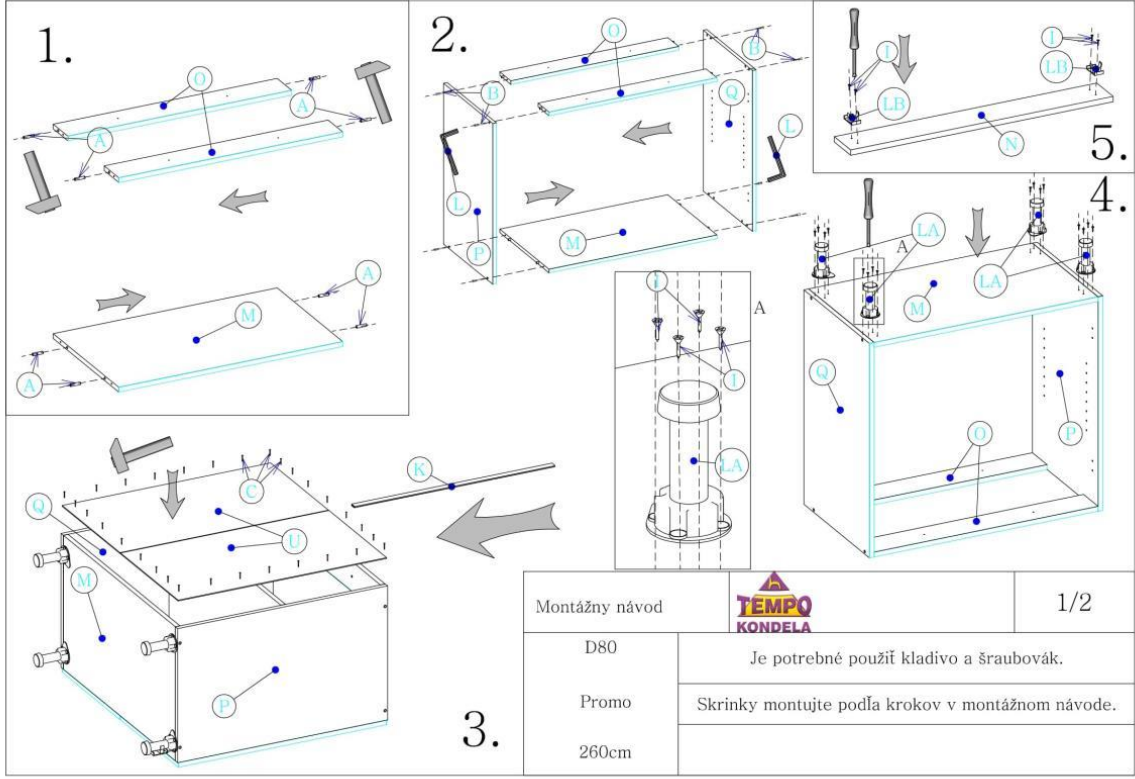

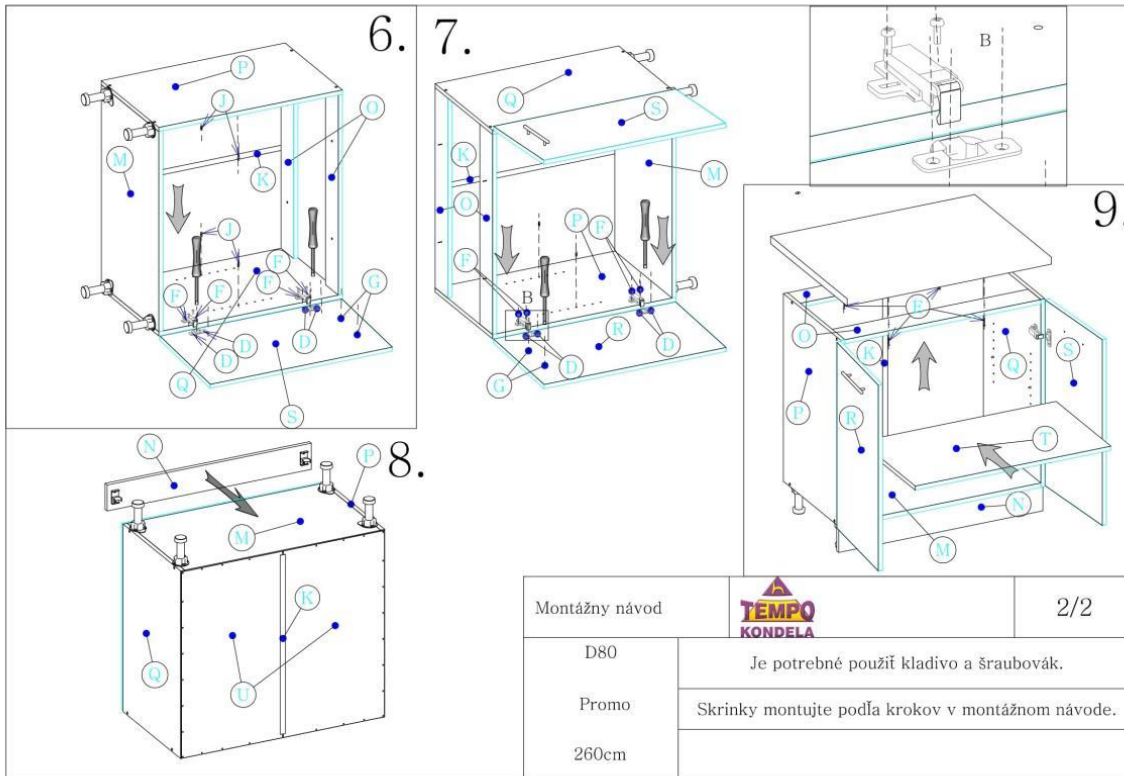

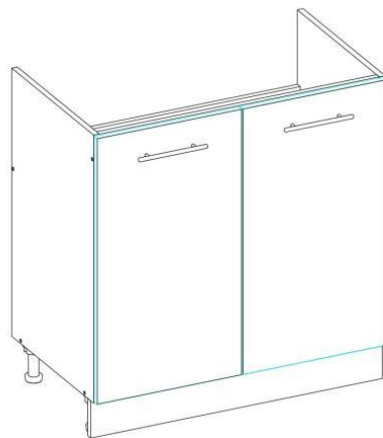
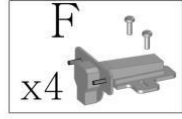
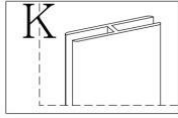
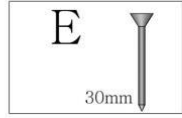
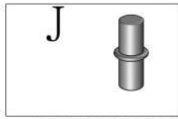
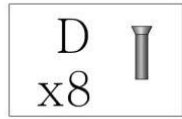
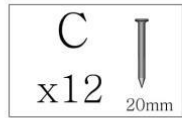
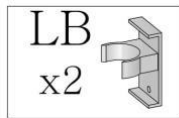
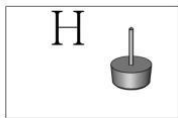
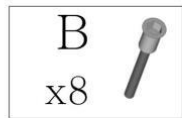
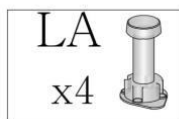
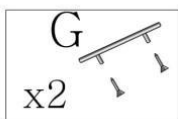
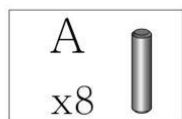

Montážny návod



1/1

D80ZL\_

Je potrebné použiť kladivo a šraubvák.

Promo

Skrinky montujte podľa krokov v montážnom návode.

260cm

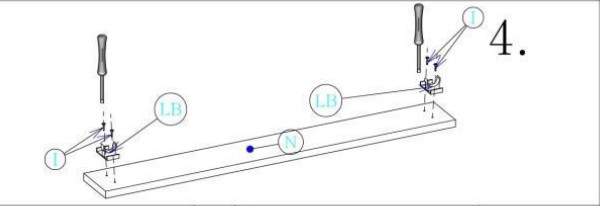
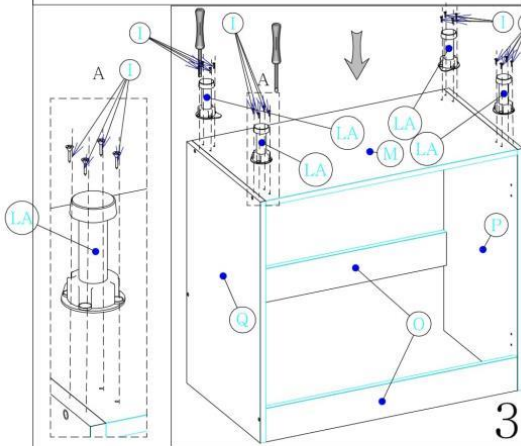
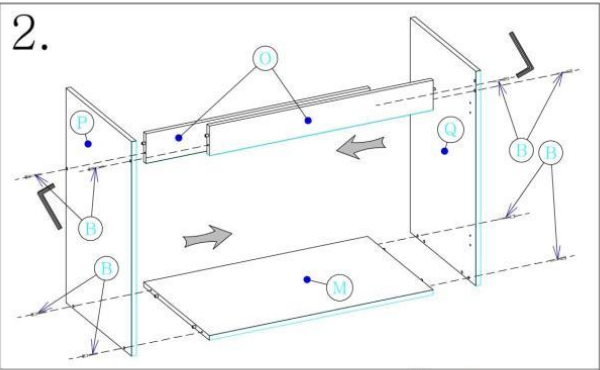
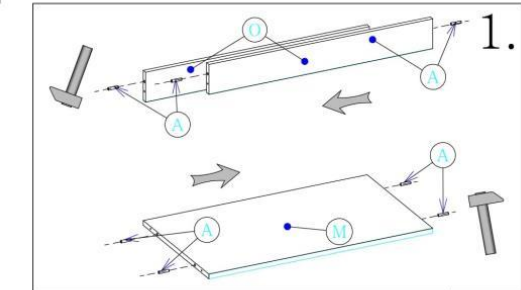

Montážny návod		1/2
D80ZL	Je potrebné použiť kladivo a šraubovák.	
Promo	Skrinky montujte podľa krokov v montážnom návode.	
260cm		



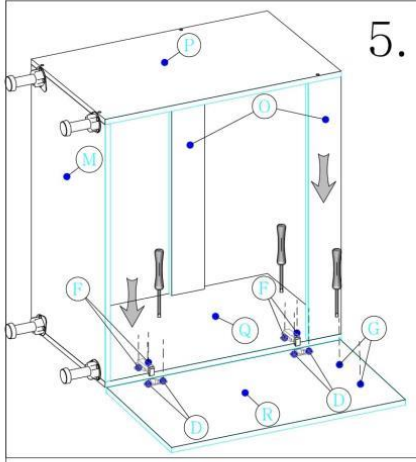

5.

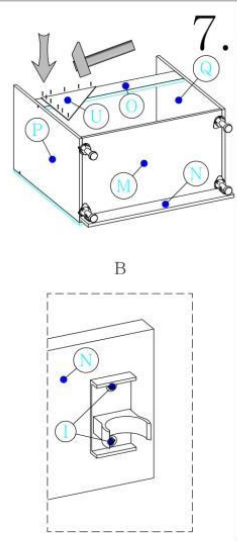

7.

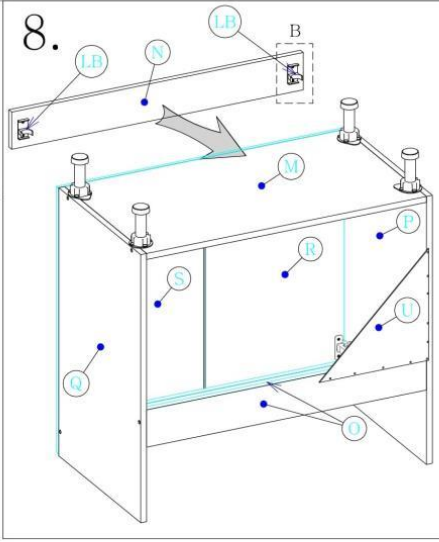

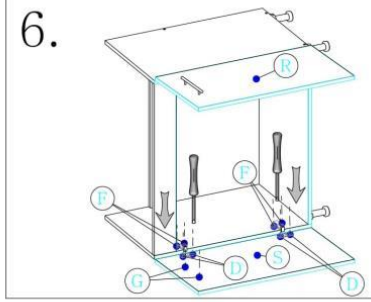

8.

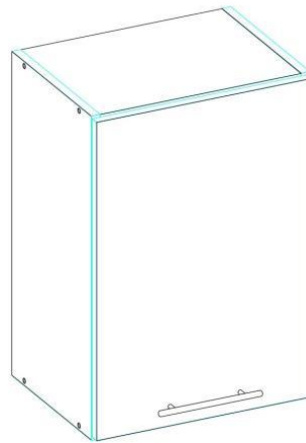
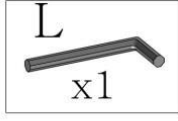
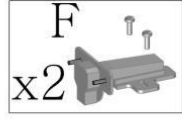
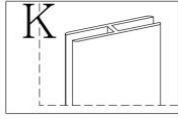
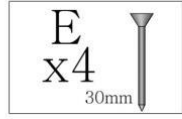
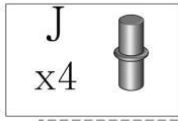
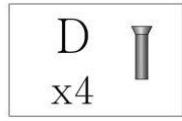
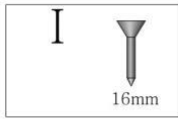
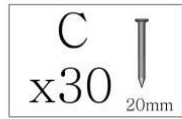
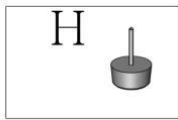
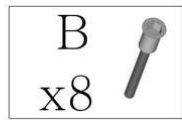
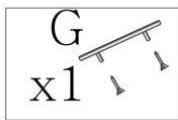
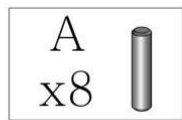

6.

Montážny návod		2/2
D80ZL	Je potrebné použiť kladivo a šraubovák.	
Promo	Skrinky montujte podľa krokov v montážnom návode.	
260cm		



Montážny návod		1/1
G40-P_	Je potrebné použiť kladivo a šraubovák.	
Promo	Skrinky montujte podľa krokov v montážnom návode.	
260cm		

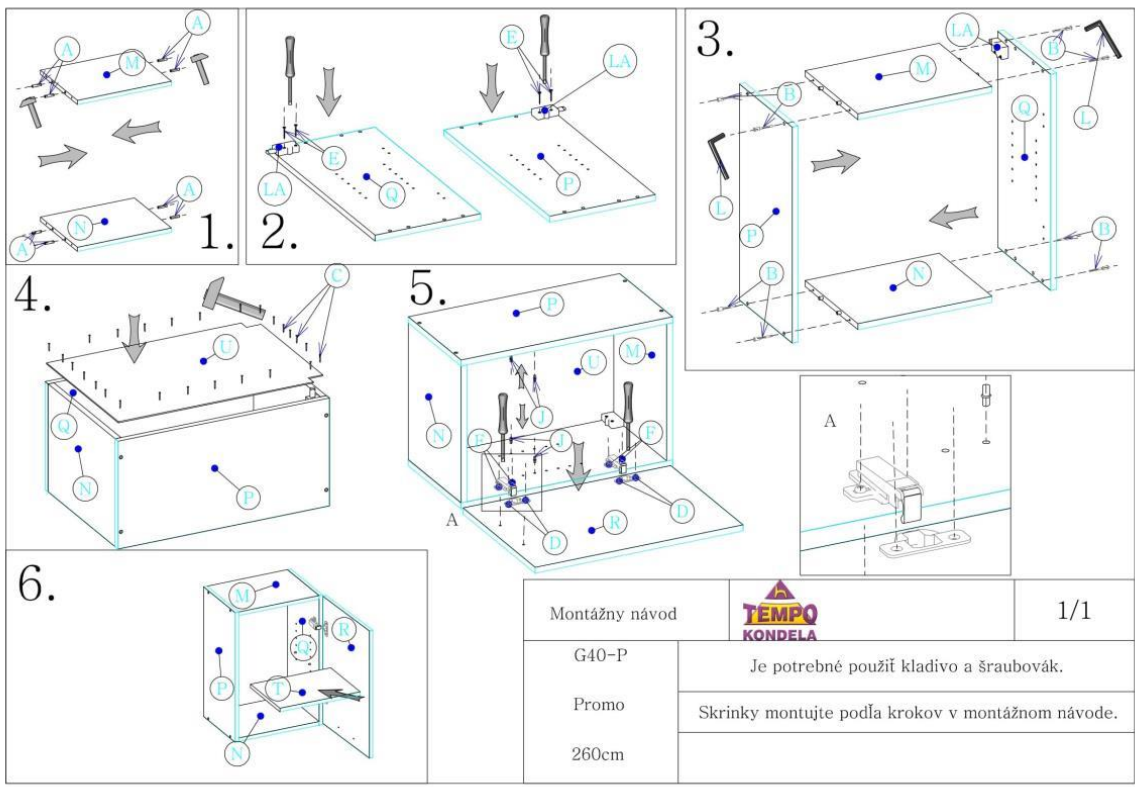

Montážny návod		1/1
G40-P	Je potrebné použiť kladivo a šraubovák.	
Promo	Skrinky montujte podľa krokov v montážnom návode.	
260cm		

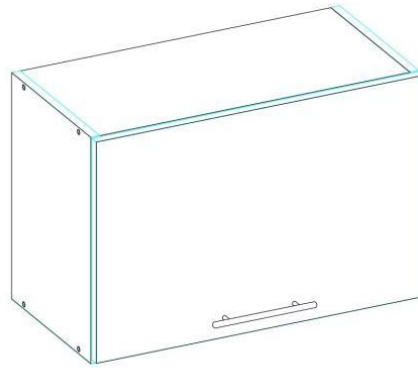
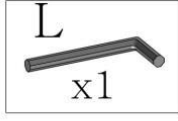
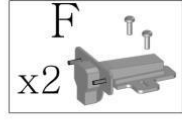
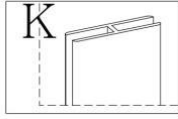
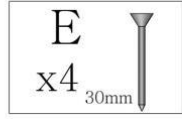
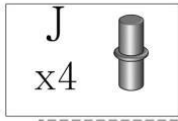
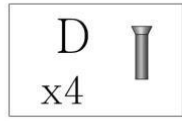
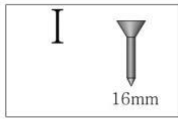
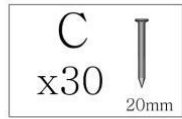
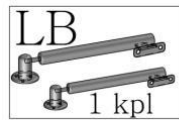
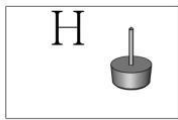
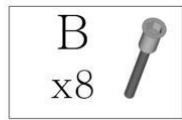
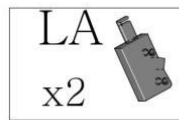
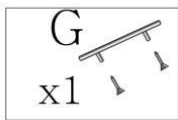
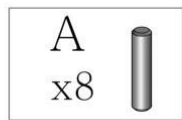

Montážny návod		2
G60-OK_	Je potrebné použiť kladivo a šraubovák.	
Promo	Skrinky montujte podľa krokov v montážnom návode.	
260cm		

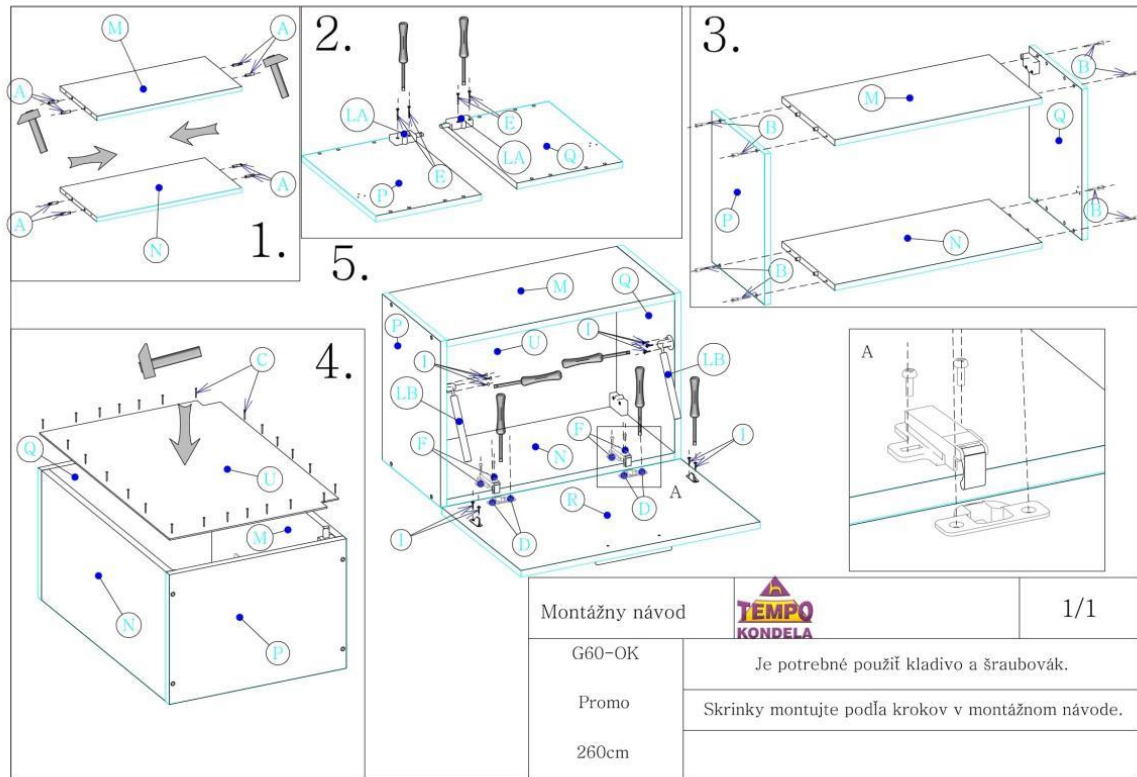

Montážny návod



1/1

G60-OK

Je potrebné použiť kladivo a šraubovák.

Promo

Skrinky montujte podľa krokov v montážnom návode.

260cm

A  
x8



G  
x2



LA  
x2



B  
x8



H  
x1



C  
x30  
20mm



I  
16mm



D  
x8



J  
x4



E  
x4  
30mm



K  
x1

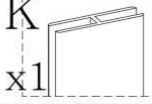

F  
x4



L  
x1

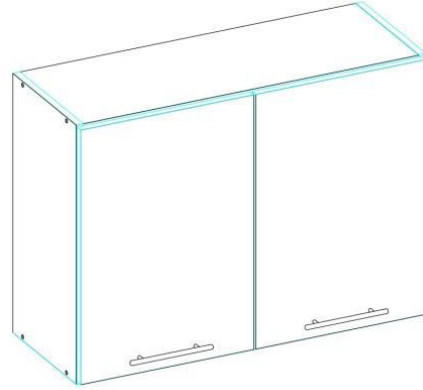

Montážny návod		1/1
G80_	Je potrebné použiť kladivo a šraubovák.	
Promo	Skrinky montujte podľa krokov v montážnom návode.	
260cm		

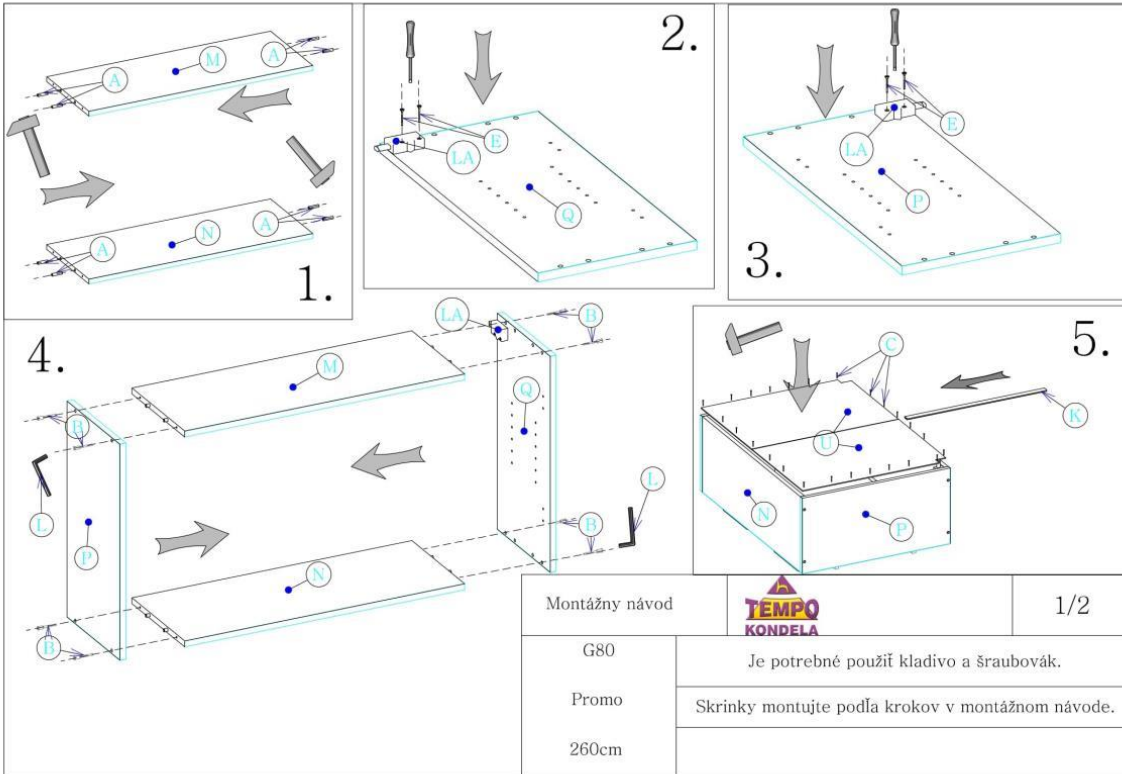

Montážny návod		1/2
G80	Je potrebné použiť kladivo a šraubovák.	
Promo	Skrinky montujte podľa krokov v montážnom návode.	
260cm		

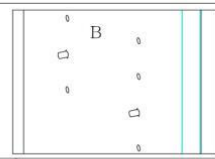
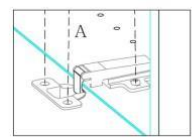
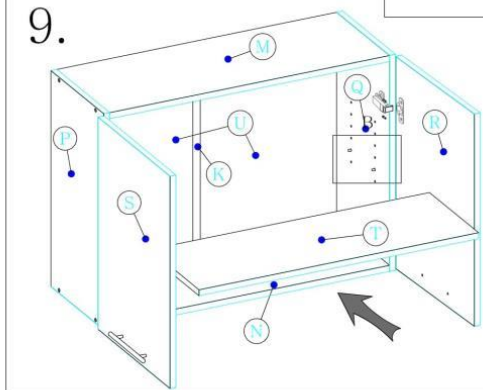
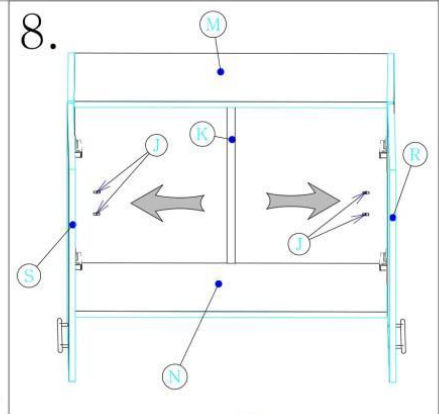
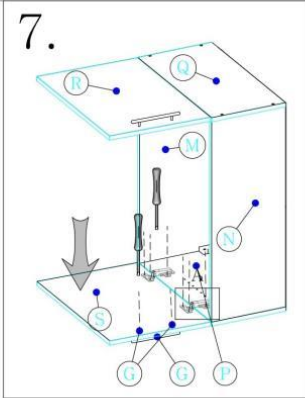
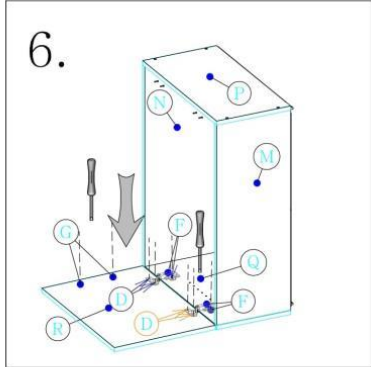

Montážny návod		2/2
G80	Je potrebné použiť kladivo a šraubovák.	
Promo	Skrinky montujte podľa krokov v montážnom návode.	
260cm		



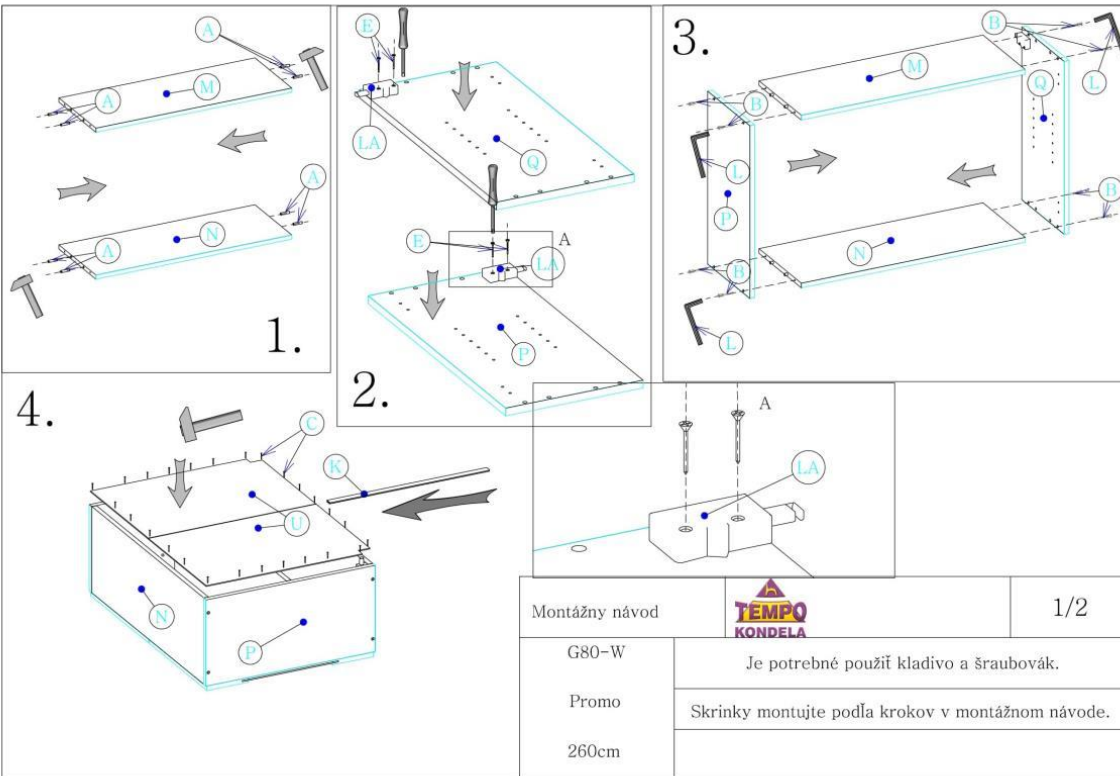

5.

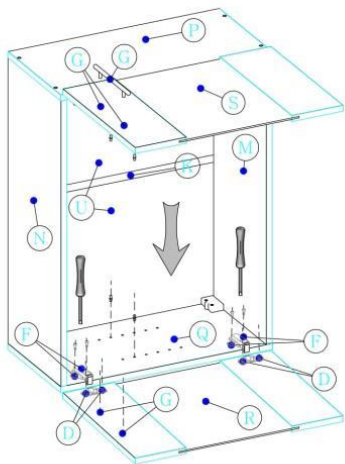

6.

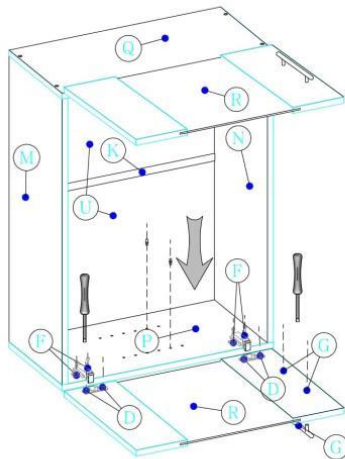

7.

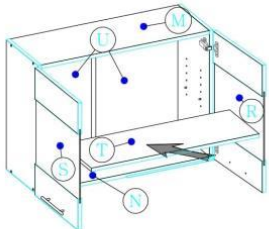

Montážny návod



2/2

G80-W

Je potrebné použiť kladivo a šraubovák.

Promo

Skrinky montujte podľa krokov v montážnom návode.

260 cm