

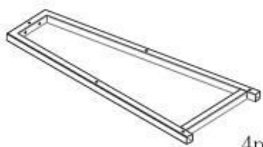









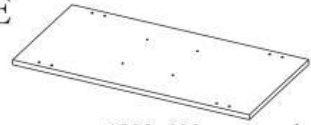

<p><b>A</b></p>  <p>4pcs</p>	<p><b>B</b></p>  <p>20x20x487mm 4pcs</p>	<p><b>C</b></p>  <p>25x25x487mm 2pcs</p>
<p><b>D</b></p>  <p>25x25x875mm 2pcs</p>	<p><b>E</b></p>  <p>1200x600mm 1pc</p>	<p><b>F</b></p>  <p>487x320mm 2pcs</p>
<p><b>G</b></p>  <p>486x250mm 2pcs</p>	<p><b>H</b></p>  <p>8pcs</p>	<p><b>I</b></p>  <p>M6x30mm 8pcs</p>
<p><b>J</b></p>  <p>M6x35mm 16pcs</p>	<p><b>K</b></p>  <p>6.3x50mm 8pcs</p>	<p><b>L</b></p>  <p>st4.8x35mm 12pcs</p>
<p><b>M</b></p>  <p>1pc</p>		



HALMAR Sp. z o.o.  
 ul. Centralnego Okręgu Przemysłowego 2, 37-450 Stalowa Wola, POLSKA / POLAND  
 tel. +48 15 843 28 10, fax: +48 15 842 19 57, e-mail: office@halmar.com.pl

v.1

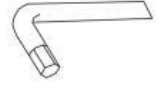
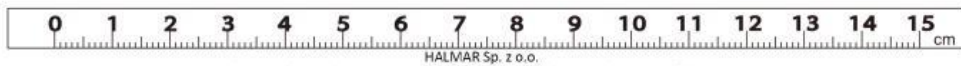
**NOWOŚĆ**

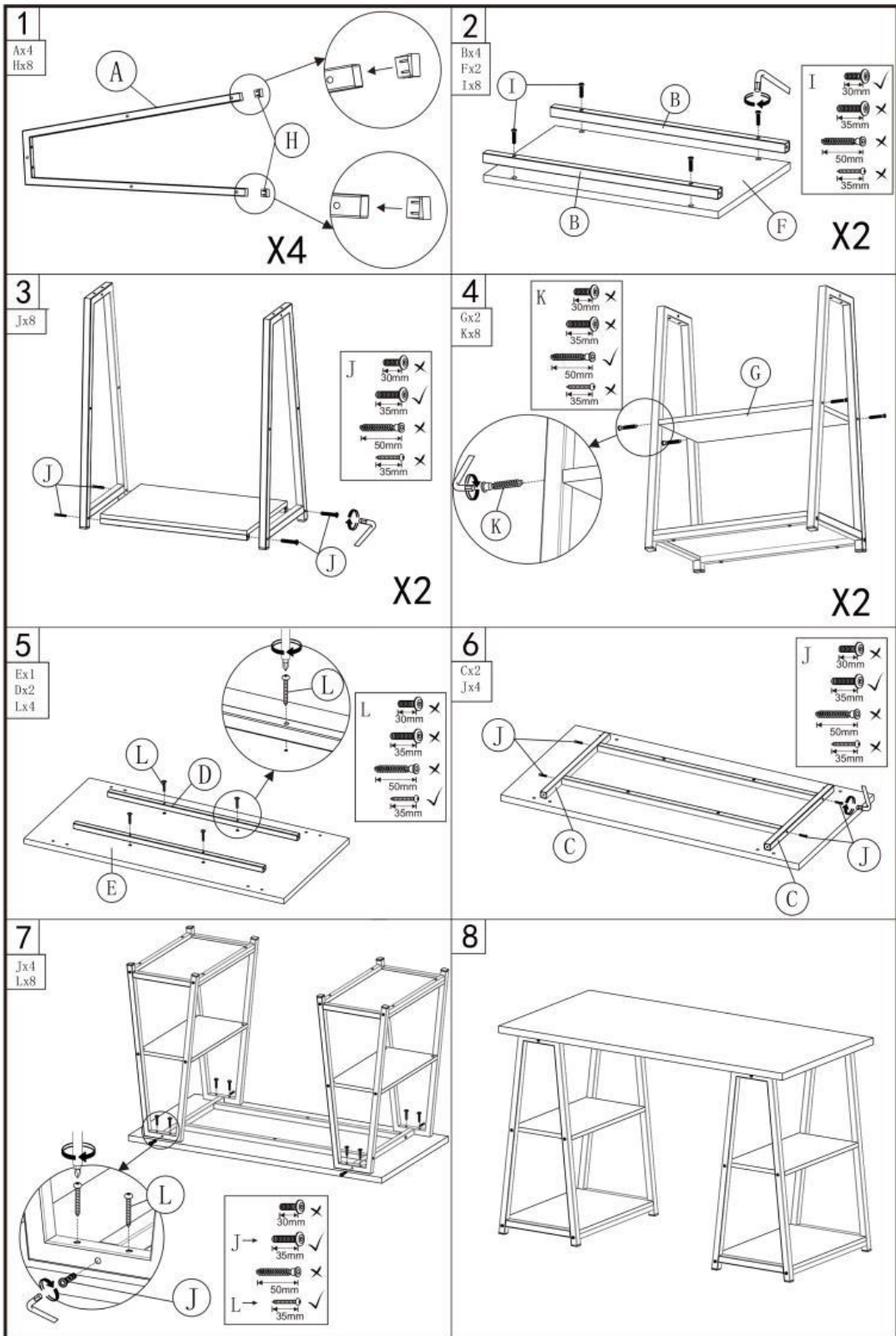

**NOWOŚĆ**