

MOBIUS - KOMODA 3S

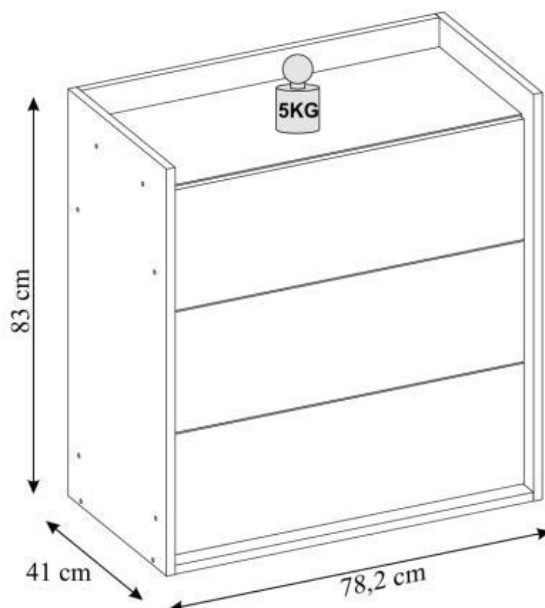

60 min.

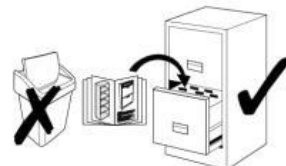

HALMAR Sp.z.o.o
ul. Centralnego Okręgu Przemysłowego 2
37-450 Stalowa Wola Polska / Poland
tel. +48 15 843 28 10, fax: +48 15 842 19 57
e-mail: office@halmar.com.pl

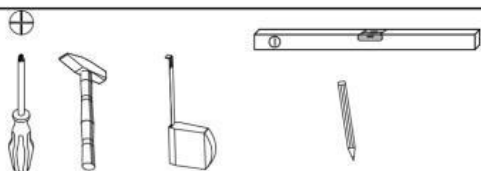

Uwaga

1. ZASADY UŻYTKOWANIA:
Maksymalne obciążenie półek regału 5 kg. Na półkach nie wolno stawiać ciężkich przedmiotów. Szafki nie należy pozostawiać w miejscu o dużej wilgotności powietrza. Wyrób należy użytkować zgodnie z jego przeznaczeniem.

2. KONSERWACJA:
Do czyszczenia zabrudzonego pokrycia tapicerskiego należy używać środków czyszczących przewidzianych do mebli tapicerowanych. Crećci z tworzyw sztucznych należy czyścić przy pomocy ogólnie dostępnych, przeznaczonych do tworzyw sztucznych, nie rysujących środków czystości. Demontaż jakichkolwiek elementów szafki może spowodować utratę stabilności. Naprawa szafki lub wymiana podszespołów może być dokonana jedynie przez przeszkolony personel.

3. RĘKOJMIĄ I GWARANCJĄ:
Firma Halmar Sp. z o.o. udziela na produkt gwarancji w postaci 12-miesięcznej rękojmi.

Attention

1. TERMS OF USE:
The maximum load of shelves is 5 kg. Do not place heavy objects on the shelves. Cupboard should not be left in a place with high humidity. The product should be used in accordance with its intended purpose.

2. MAINTENANCE:
For cleaning dirty upholstery covering use cleaners intended for upholstered furniture. Plastic parts should be cleaned with a commercially available, non-abrasive cleaning agents intended for plastic surfaces. Disassembling any of the cupboard element may result in loss of stability of the cupboard. Repair or replacement of cupboard components can only be done by trained personnel.

3. WARRANTY AND GUARANTEE:
Company Halmar L.L.C. provides a product guarantee in the form of a 12-month warranty.

MOBIUS - KOMODA 3S

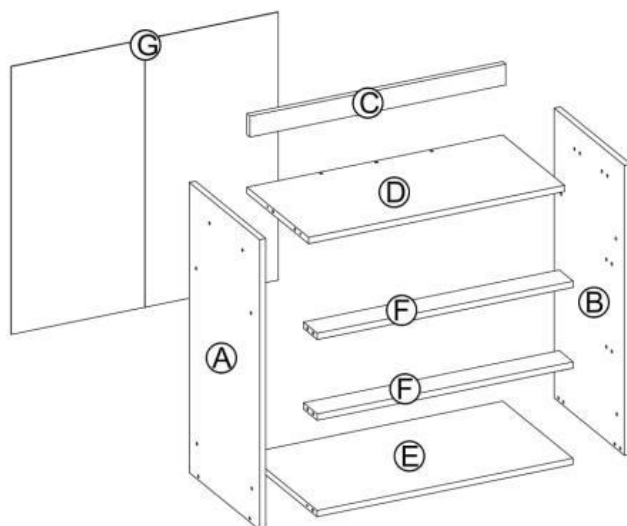

| | Kod | Wymiar | Szt. |
|---|---------|------------|------|
| Ⓐ | MB05-01 | 830x410x18 | 1 |
| Ⓑ | MB05-02 | 830x410x18 | 1 |
| Ⓒ | MB05-03 | 746x60x18 | 1 |
| Ⓓ | MB05-04 | 746x360x18 | 1 |
| Ⓔ | MB05-05 | 746x409x18 | 1 |
| Ⓕ | MB05-06 | 746x80x18 | 2 |
| Ⓖ | MB05-07 | 766x778x3 | 1 |
| Ⓕ | MB05-08 | 740x246x18 | 3 |
| Ⓛ | MB05-09 | 685x159x18 | 3 |
| Ⓜ | MB05-10 | 350x160x18 | 6 |
| Ⓝ | MB05-11 | 685x159x18 | 3 |
| Ⓓ | MB05-12 | 348x719x3 | 3 |

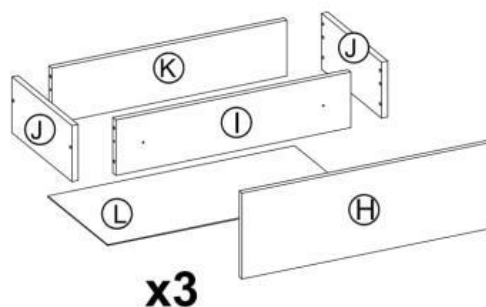











UWAGA

Instrukcja montażu nie jest dokumentacją techniczną, producent zastrzega sobie możliwość zmian konstrukcyjnych.

Przed przystąpieniem do montażu należy sprawdzić zawartość paczek pod względem ilości i jakości z instrukcją montażu.

NIE WOLNO montować uszkodzonych elementów mebli, ewentualne ich wady należy zgłosić przed montażem w przeciwnym razie nie będą one podlegać reklamacji.

MOBIUS - KOMODA 3S

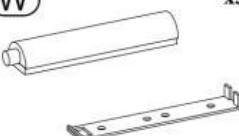
| | | | |
|--|--|--|---|
| <p>(M) x42</p>  <p>ø 8x30</p> | <p>(N) x17</p>  <p>ø 13</p> | <p>(O) x21</p>  <p>7x50</p> | <p>(P) x8</p>  <p>ø 6x25</p> |
| <p>(Q) x6</p>  <p>ø 4x25</p> | <p>(R) x1</p>  | <p>(S) x42</p>  <p>ø 3,5x16</p> | <p>(T) x80</p>  |
| <p>(U) x3</p>  <p>L-350</p> | | <p>(V) x6</p>  | <p>(W) x3</p>  |

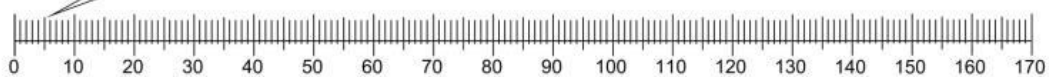
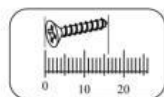

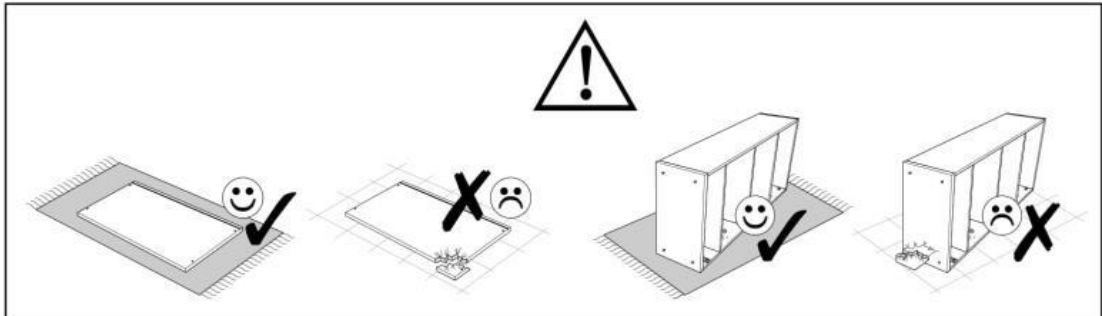

1

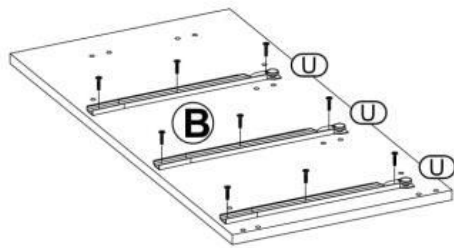
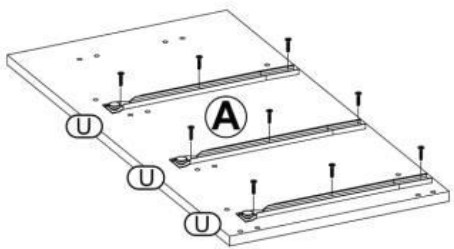
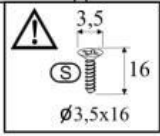
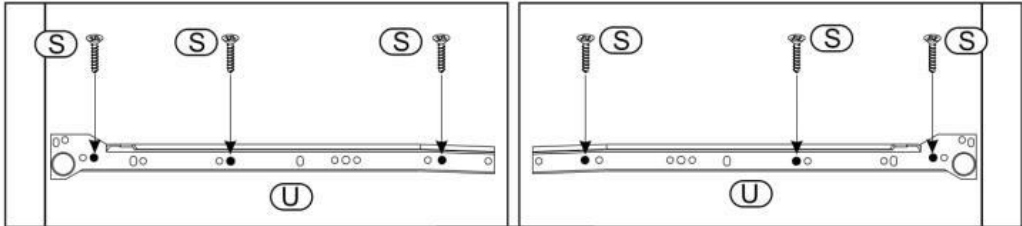

2

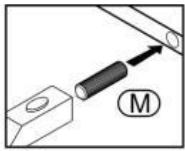
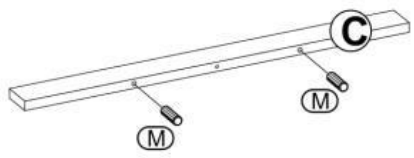
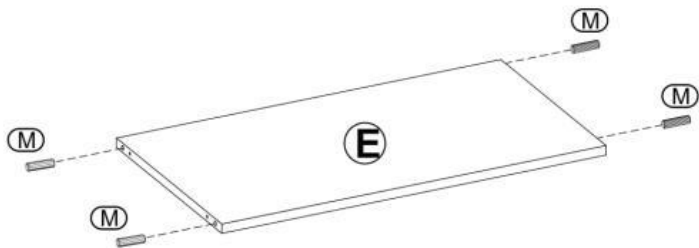

3

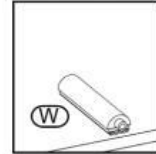
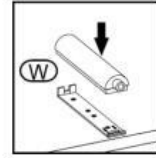
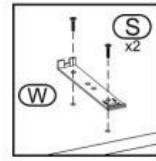
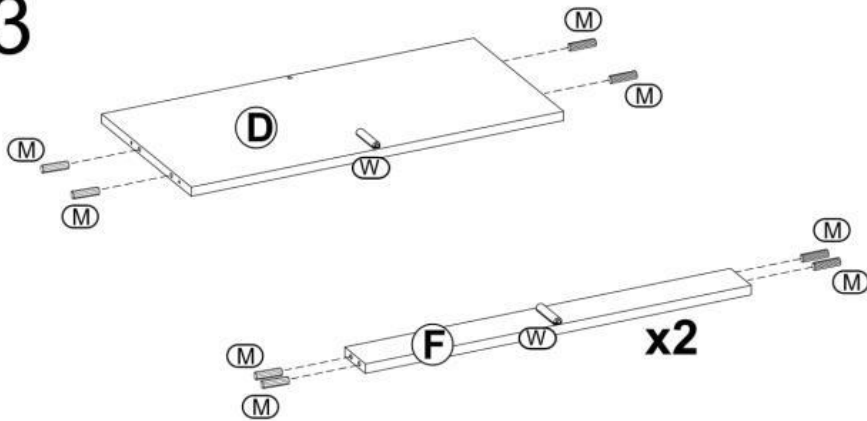

4

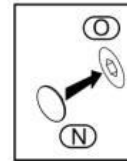
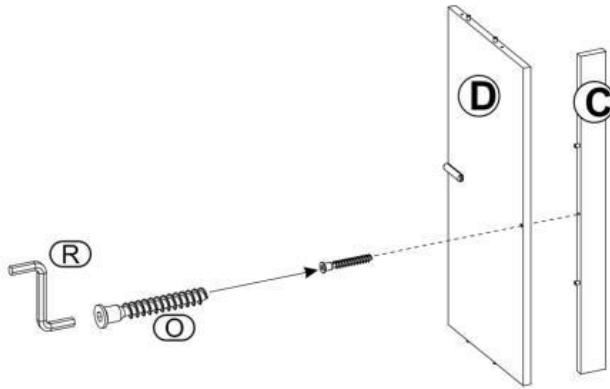

5

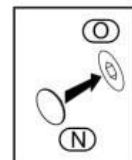
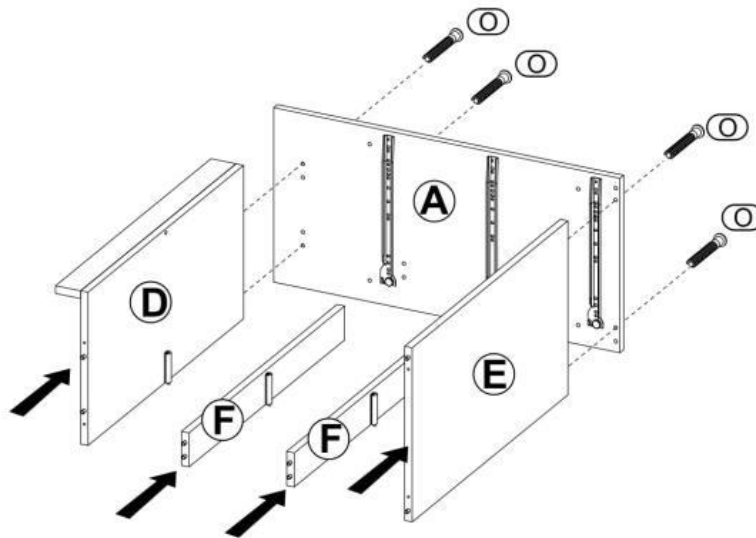

6

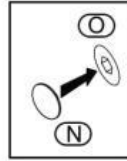
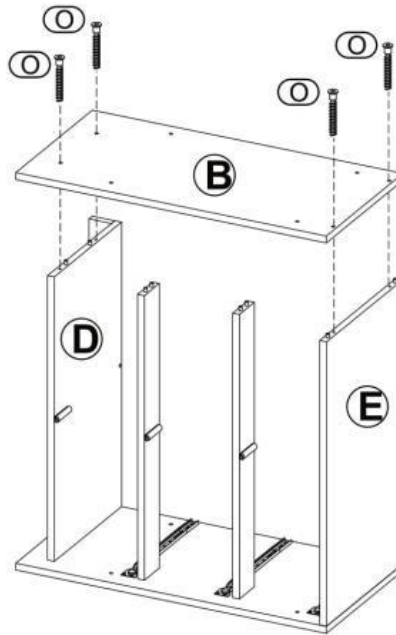

7

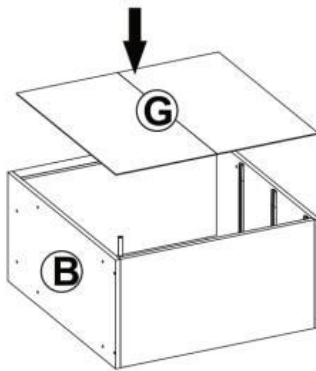

UWAGA !!!



$A=B$

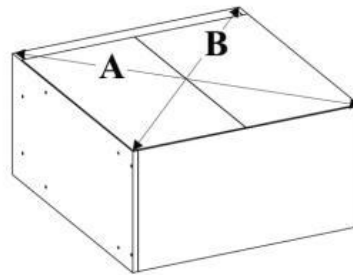

Uwaga !!!

Przed zamocowaniem ściany tylnej należy zmierzyć przekątne szafki. Jeżeli wymiary są jednakowe to możemy przystąpić do zamocowania jej, jeżeli nie to musimy do tego doprowadzić ściskając przeciwległe rogi szafki, tam gdzie wymiar był większy.

Nieprawidłowe ustawienie przekątnych przed montażem ściany tylnej uniemożliwi prawidłowe późniejsze wyregulowanie frontów.

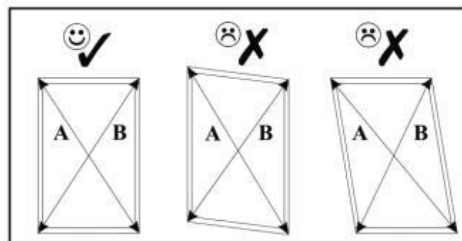

8

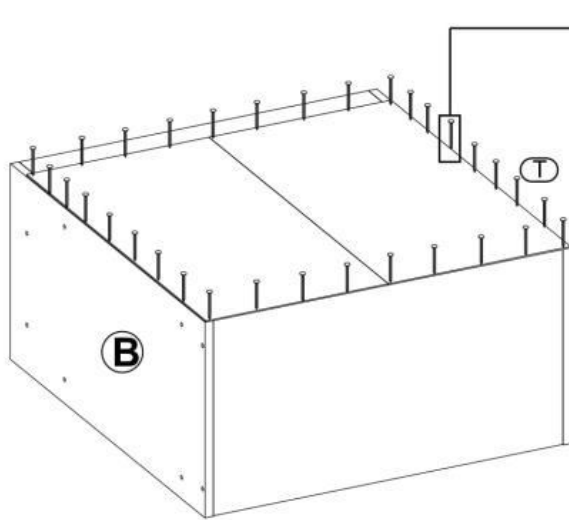

x32

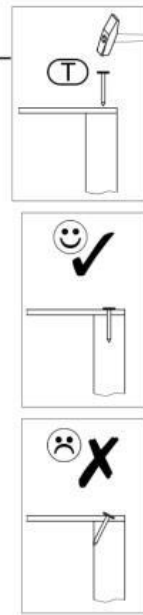

9

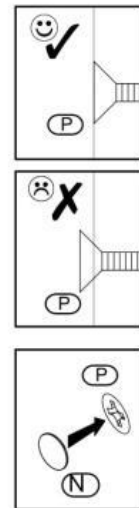
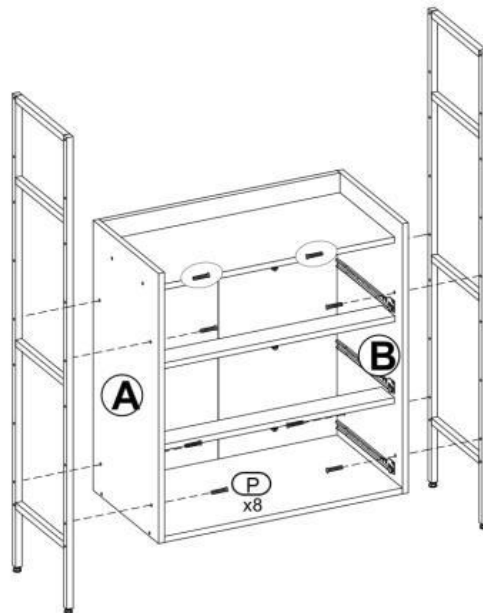
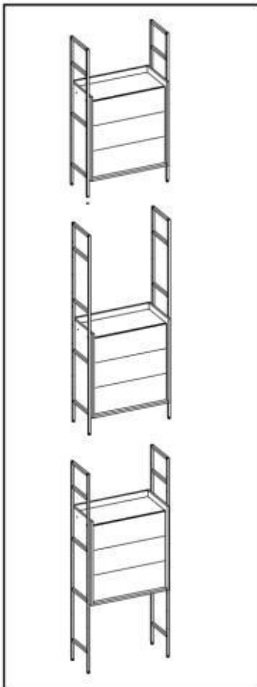
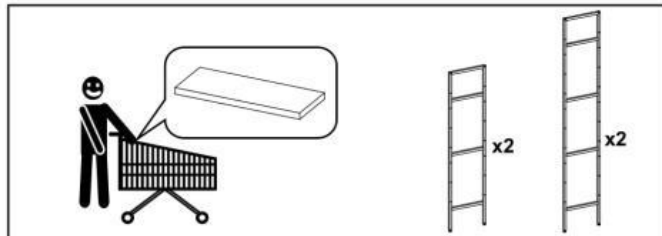

10



Zwróć szczególną uwagę na prawidłowe zamocowanie regulatora frontu.

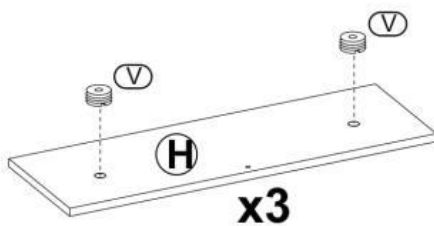
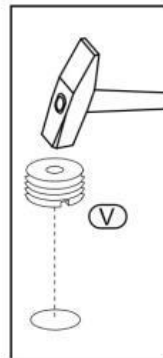
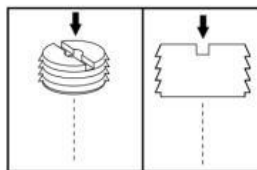
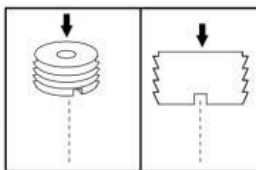

11

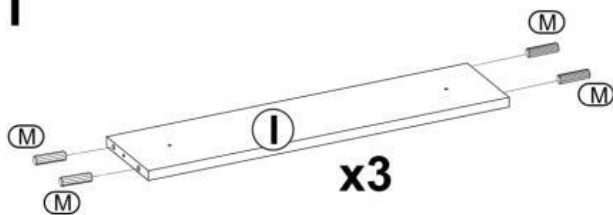

x3

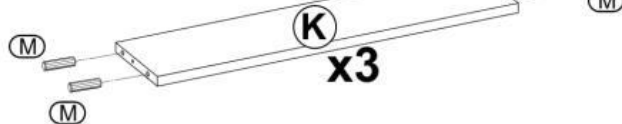

x3

12

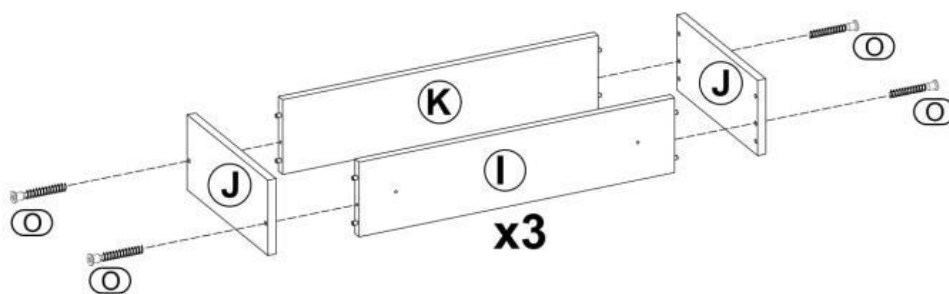

x3

13

Uwaga !!!

Przed zamocowaniem dna szuflady należy zmierzyć przekątne szuflady. Jeżeli wymiary są jednakowe to możemy przystąpić do zamocowania jej, jeżeli nie to musimy do tego doprowadzić ściskając przeciwległe rogi szuflady, tam gdzie wymiar był większy.

A=B

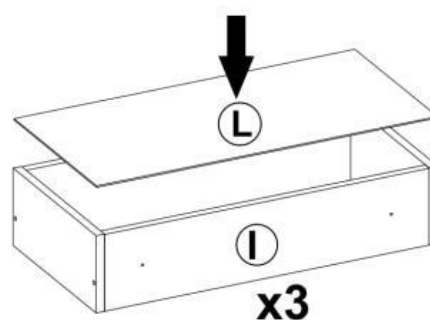
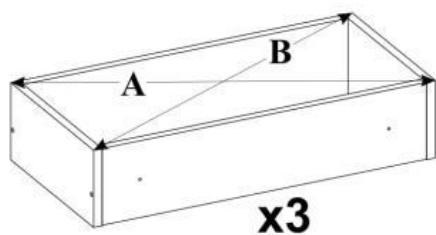

14

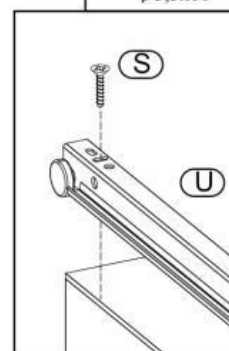
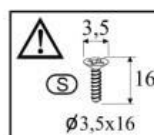
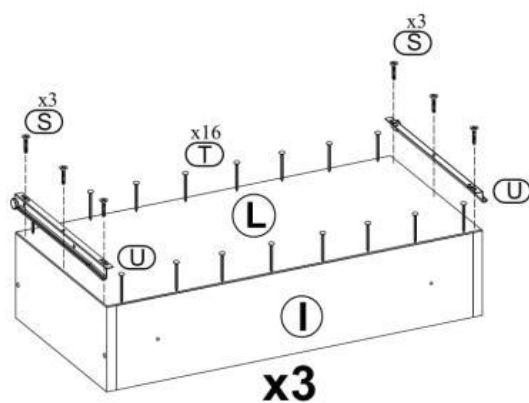

15



Uwaga

Przed całkowitym dokręceniem frontu możliwa jest jego regulacja.

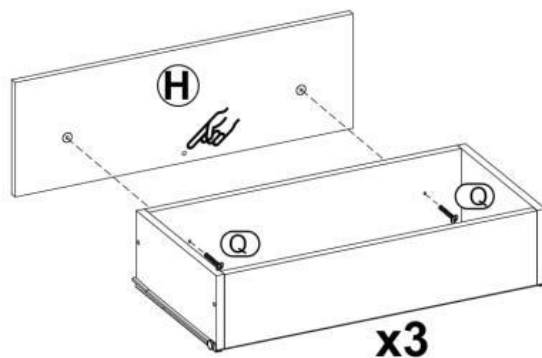
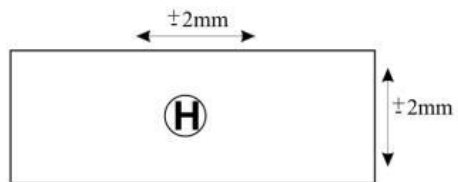
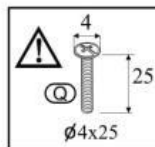

16

