

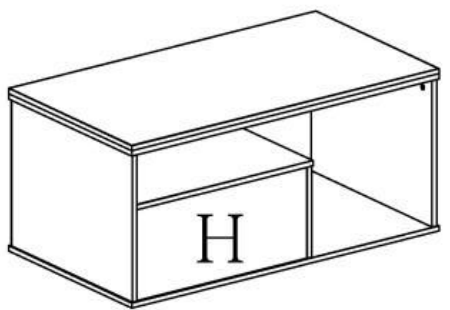

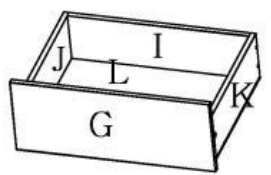

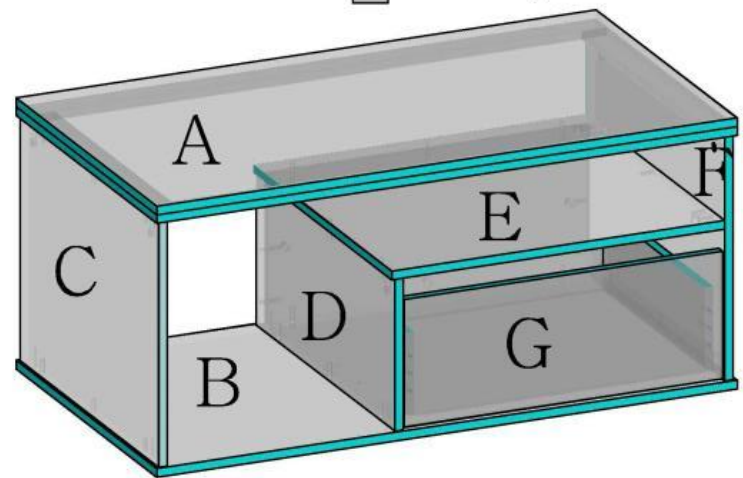















NOVOFC

PANTERA

1100x600x500

 max. 20kg



A		1
B		1
C		1
D		1
E		1
F		1
G		1
H		1
I		1
J		1
K		1
L		1
M		33
N		10
O		20
P		12
Q		14
R		4
S		1

HALMAR Sp. z o.o.

ul. Centralnego Odkregu Przemysłowego 2, 37-450 Stalowa Wola, POLSKA/POLAND
 tel. +48 15 843 28 10, fax: +48 16 842 19 57, e-mail office@halmar.com.pl

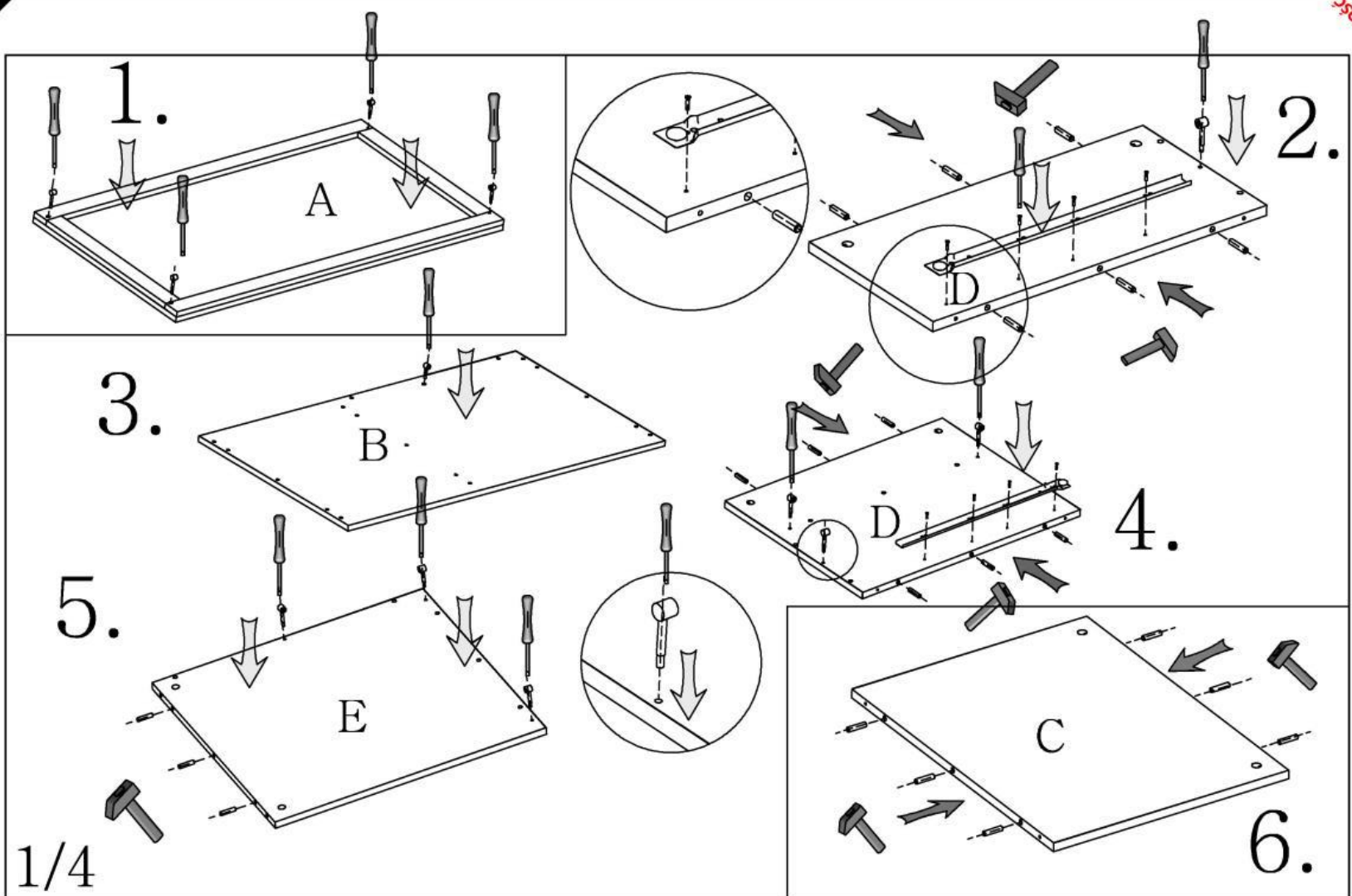

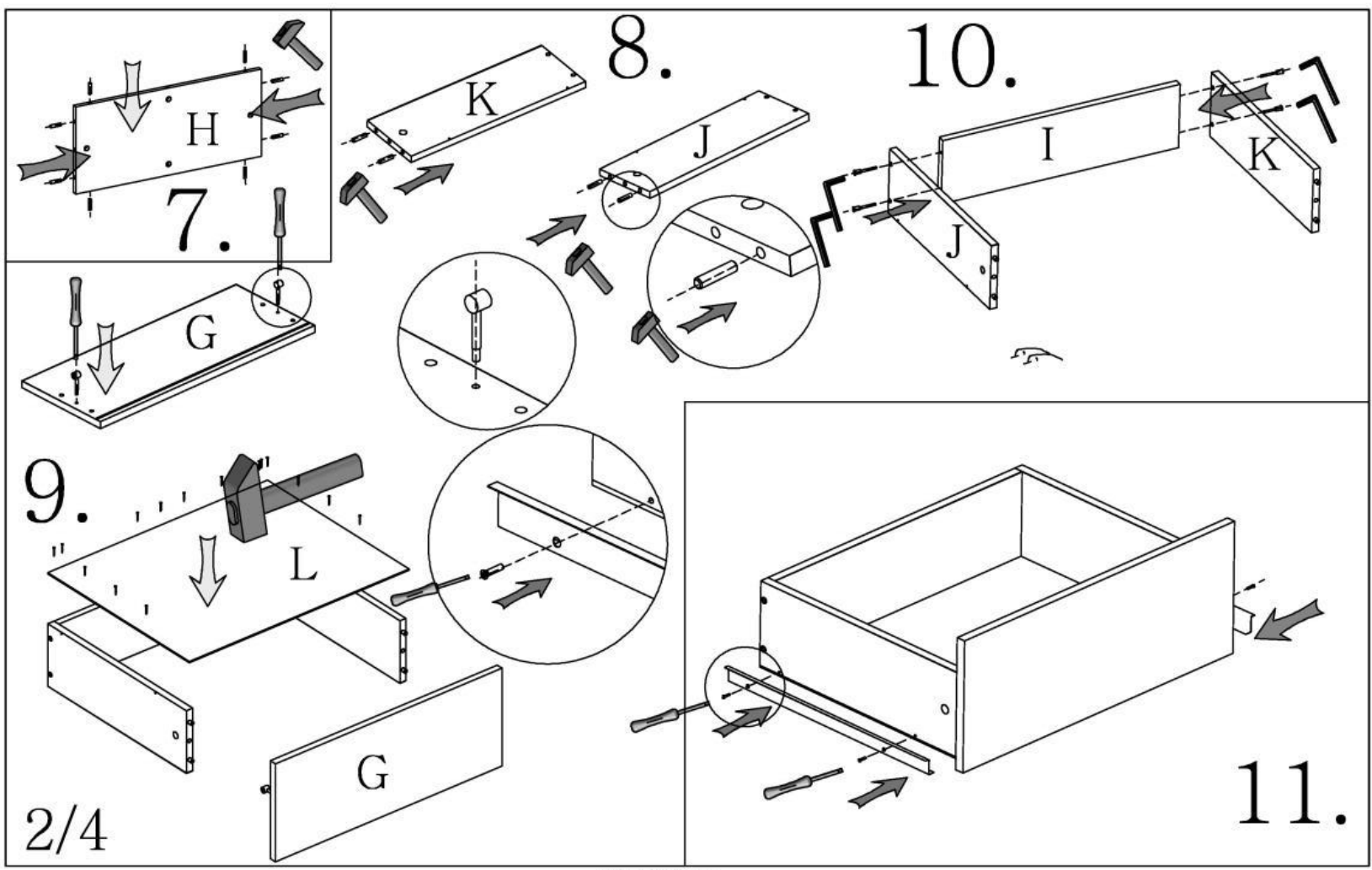

12.

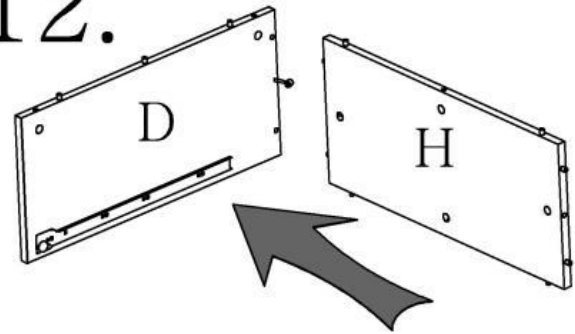

13.

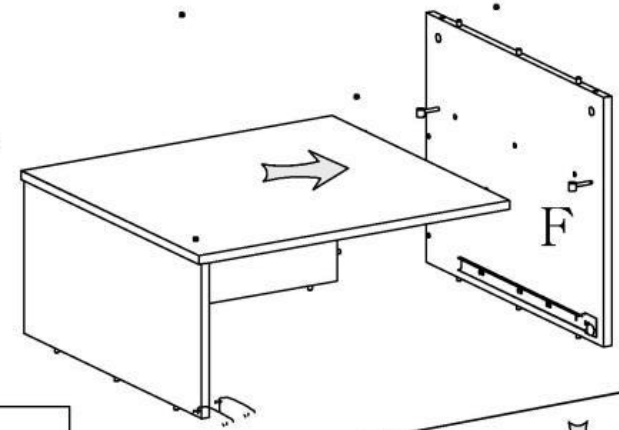

14.

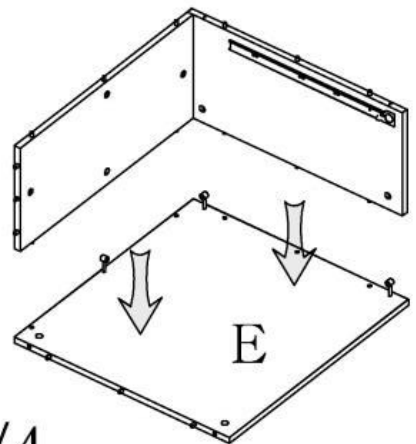

3/4

15.

