

980 x 615 x 165

EN

Returns of the assembled furniture will not be accepted.

Before attempting to assembly this product please check the contents of the package. If any components are missing or damaged, please contact the retailer from whom you bought this product.

PL

Zwroty skręconych mebli nie są przyjmowane.

Przed przystąpieniem do montażu należy sprawdzić czy nie brakuje żadnych części oraz czy nie są uszkodzone. Jeżeli brakuje części lub są uszkodzona, proszę skontaktować się z lokalnym dostawcą.

FR

Les retours ne sont pas acceptés une fois le meuble monté.

Avant de commencer le montage du meuble, veuillez vérifier que chaque emballage contient toutes les pièces. Si une pièce venait à manquer ou était endommagée, merci de contacter le revendeur auprès duquel vous avez effectué votre achat.

D

Die Rückgabe montierter Möbel wird nicht berücksichtigt.

Vor der Montage ist zu prüfen, ob alle Bestandteile vorhanden und nicht beschädigt
Falls Teile fehlen oder beschädigt sind, bitte mit dem lokalen Lieferanten in Kontakt treten.

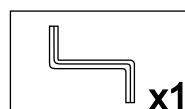
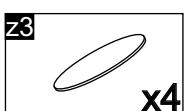
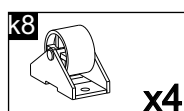
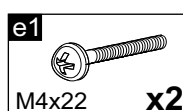
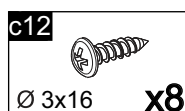
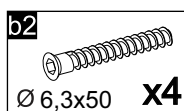
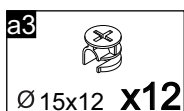
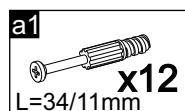

0 10 20 30 40 50 60 70 80 90 100 110 120 130 140 150 mm



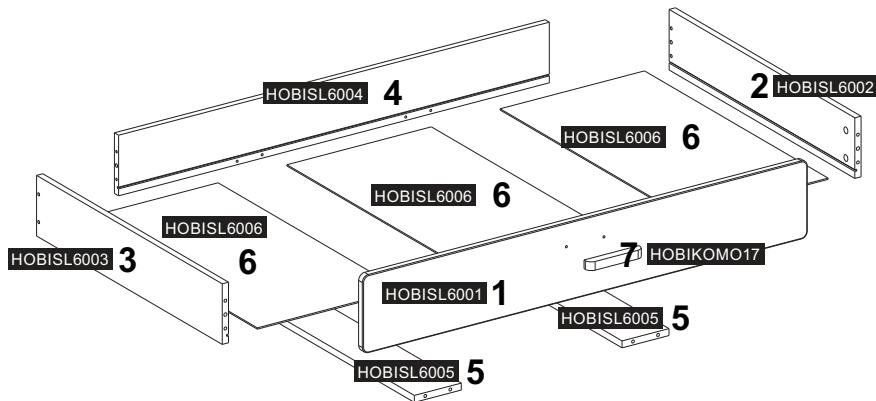
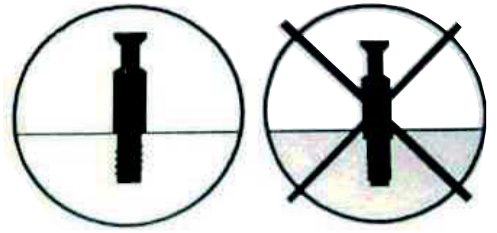
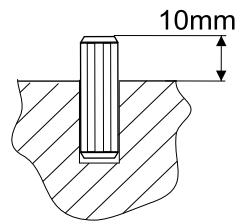
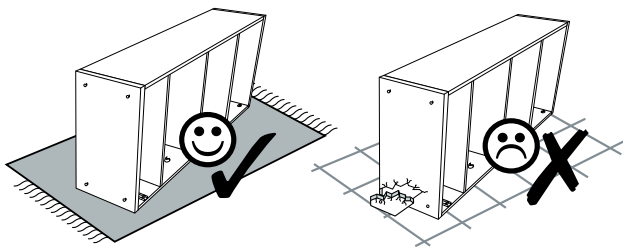

EN Cleaning and maintenance

1. Use generally available furniture cleaning detergents.
2. Do not use aggressive detergents and always read the detergent's usage instructions.
3. Do not use hard brushes or any other harsh materials that could streak the surface of the furniture.

PL Czyszczenie i pielęgnacja

1. Używać należy ogólnie dostępnych środków ochrony mebli drewnianych.
2. Nie stosować agresywnych środków czyszczących i zawsze zapoznać się z uwagami producenta tego preparatu.
3. Nie stosować twardych szczotek czy szorstkich ścierek mogących porysować powierzchnie mebli.

FR Nettoyage et entretien

1. Utiliser les détergents habituels pour meubles.
2. Ne pas utiliser de détergents trop abrasifs et toujours lire les notices d'utilisation de chaque produit.
3. Ne pas utiliser de brosses trop fortes et ou d'autres matériaux abrasifs qui pourraient abîmer la surface du meuble.

D Reinigung und Pflege

1. Bitte verwenden Sie allgemein zugängliche Möbelschutzmittel.
2. Verwenden Sie keine aggressiven Reinigungsmittel. Vor Anwendung ist immer die Gebrauchsanweisung des Herstellers des jeweiligen Reinigungsmittels zu beachten.
3. Verwendung harter Bürsten und rauer Lappen kann die Oberfläche der Möbel beschädigen.

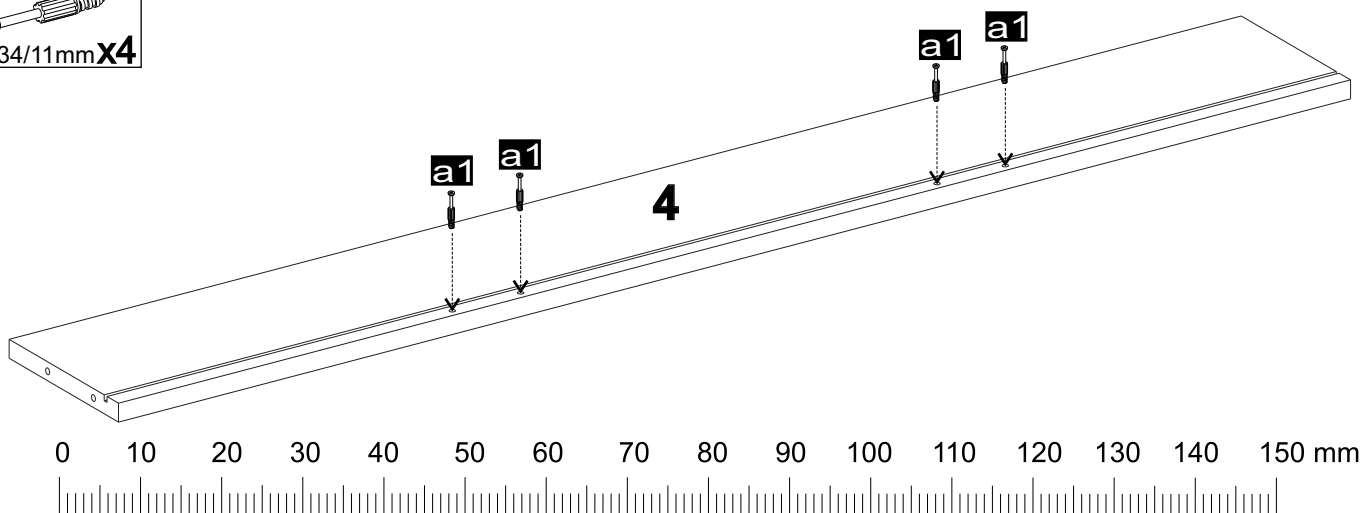
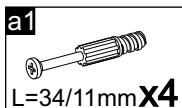
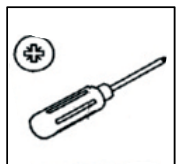

2

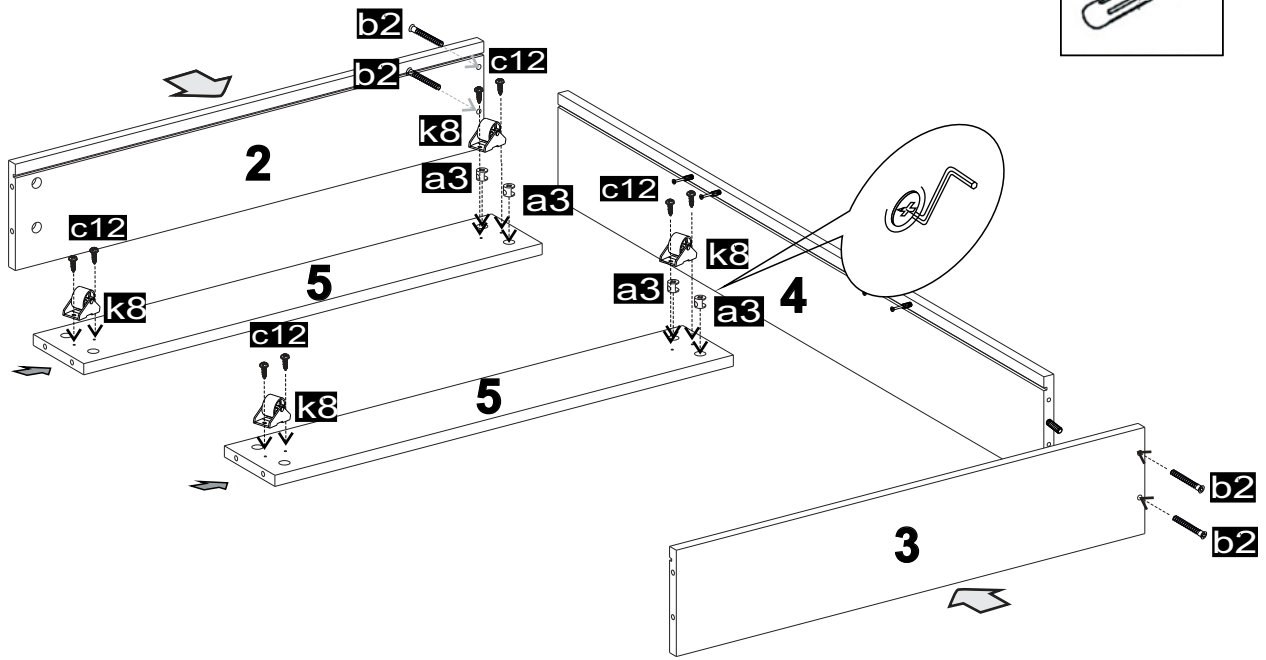
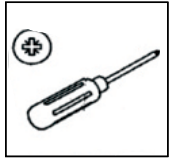
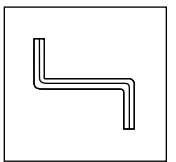
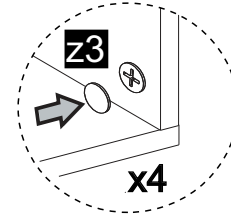
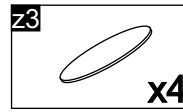
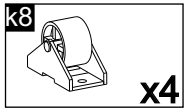
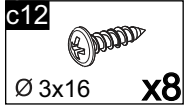
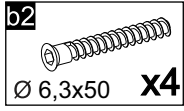
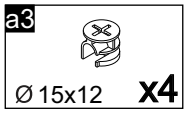

3

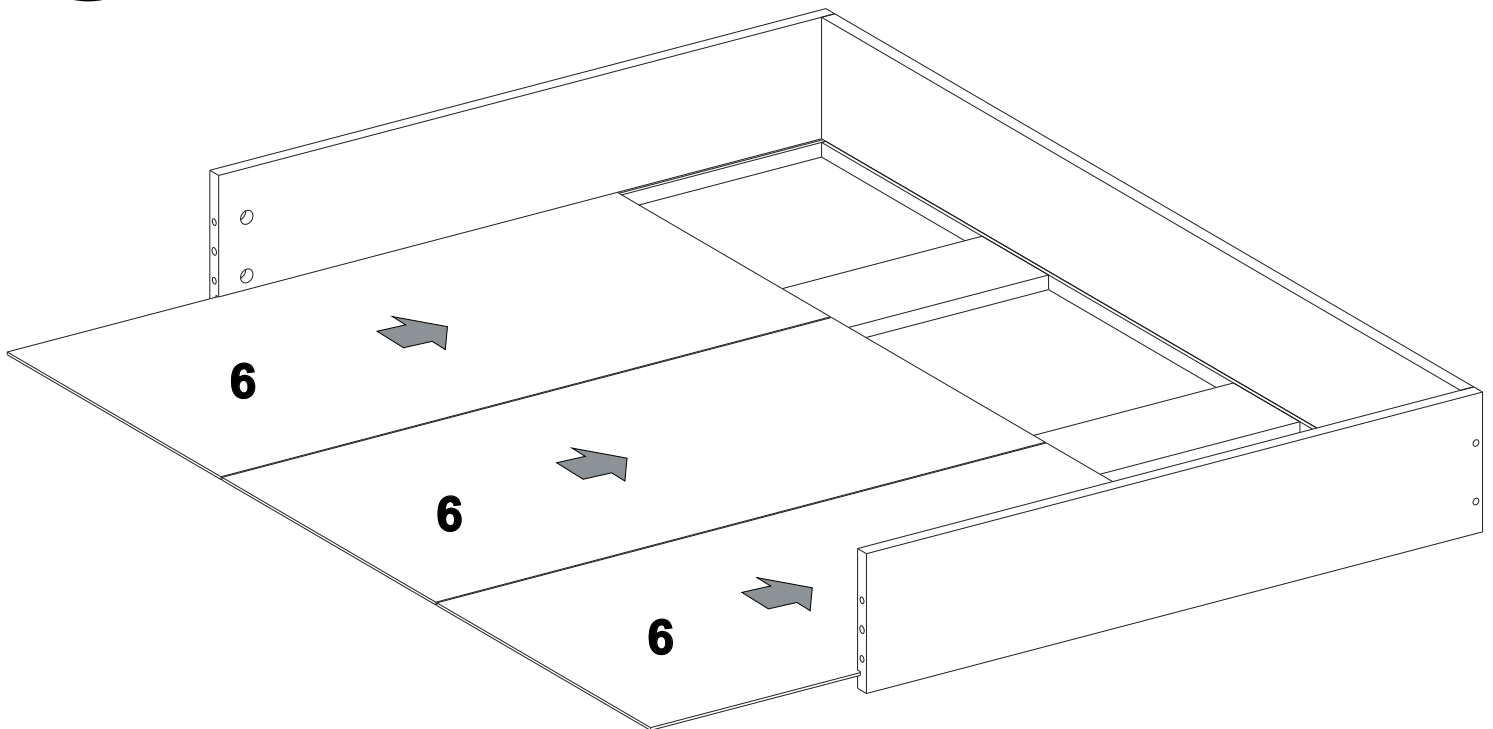

4

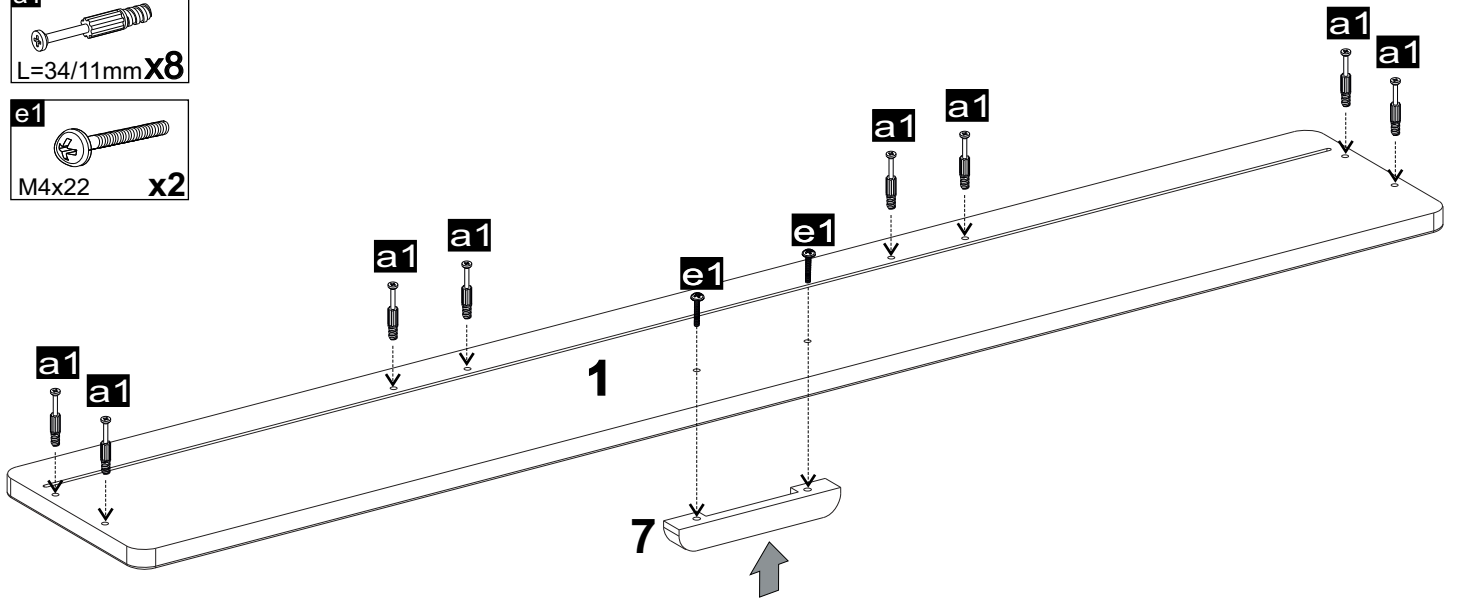
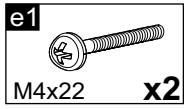
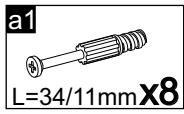
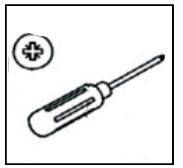

5

