

TATIANA, modul č. 5

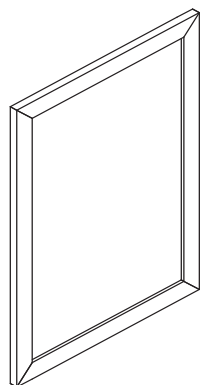

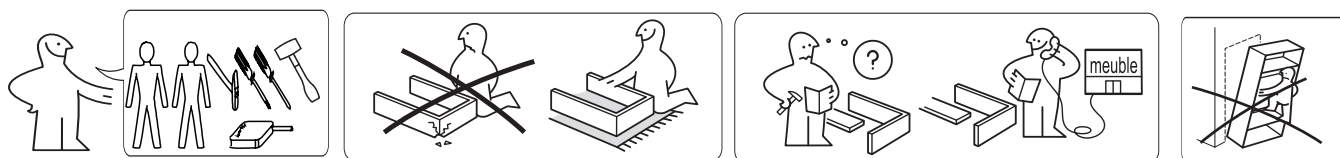

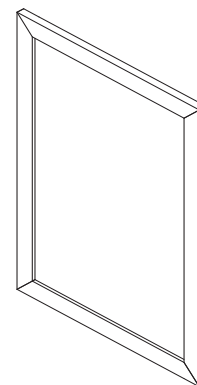









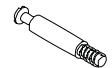

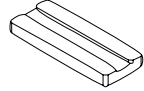

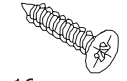
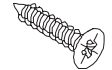
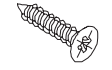

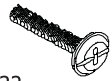
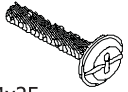





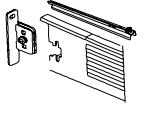



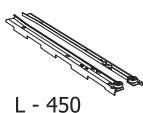
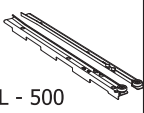
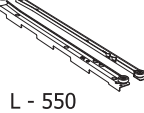

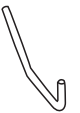

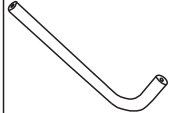
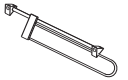
p.č	názov	ks	rozměr V x Š /mm/
1.	zrkadlo	1	762 x 512



Pred montážou je potrebné sa oboznámiť s návodom na montáž !

Pozor:

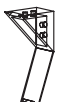
- Počas montáže treba jednotlivé časti položiť na mäkkú a čistú podložku, napr.: uterák, deka. Nemontujte nábytok na koberci, parketách atď.
- Ak zabijate kolíky do otvorov o priemere 8 mm, ktoré sa nachádzajú na hranách elementov.. **Pozor:** V prípade, že niektorý z kolíkov z otvoru prečnieva viac ako 10 mm, je potrebné ho dobiť, vymeniť alebo skrátiť, pretože môže pri skladaní spôsobiť poškodenie boku.
- Pred prbitím sololitu skontrolujte, či sú rovnaké uhlopriečky.

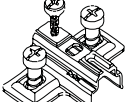
(A) 0 ks  8x35	(B) 0 ks  5x50	(C) 0 ks 	(D) 0 ks 	(E) 0 ks 	(F) 0 ks 	(G) 0 ks 	(H) 0 ks  6x13
(CH) 0 ks  3,5x16	(Ch1) 0 ks  4x16	(Ch2) 0 ks 	(Ch3) 0 ks 	(Ch4) 0 ks 	(I) 0 ks 	(J) 0 ks  4x22	(J1) 0 ks  4x25
(K) 0 ks  5x10	(K1) 0 ks 	(L) 0 ks 	(M) 0 ks 	(N) 0 ks 	(O) 0 ks 	(P) 0 pár  L - 250	(P1) 0 pár  L - 300
(P2) 0 pár  L - 400	(P3) 0 pár  L - 450	(P4) 0 pár  L - 500	(P5) 0 pár  L - 550	(R) 0 ks 	(S) 0 ks 	(S1) 0 ks 	(S2) 0 ks 
(V1) 0 ks  výsuvný vešiak L 300	(T) 0 ks 	(T1) 0 ks 	(T2) 0 ks 	(T3) 0 ks 	(Q) 0 ks  1,4x25	(U) 0 ks 	(V) 2 ks 
(X) 0 ks 	(Y) 0 ks 	(Z) 0 ks	(z1) 0 ks 	(z2) 0 ks	(Z) 0 ks záves naložený	(Z1) 0 ks záves vložený	(Z2) 0 ks záves polonaložený

1/2

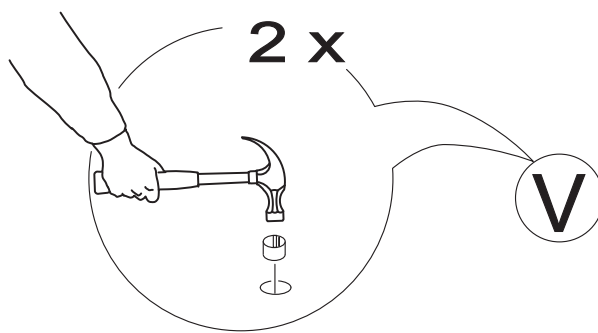
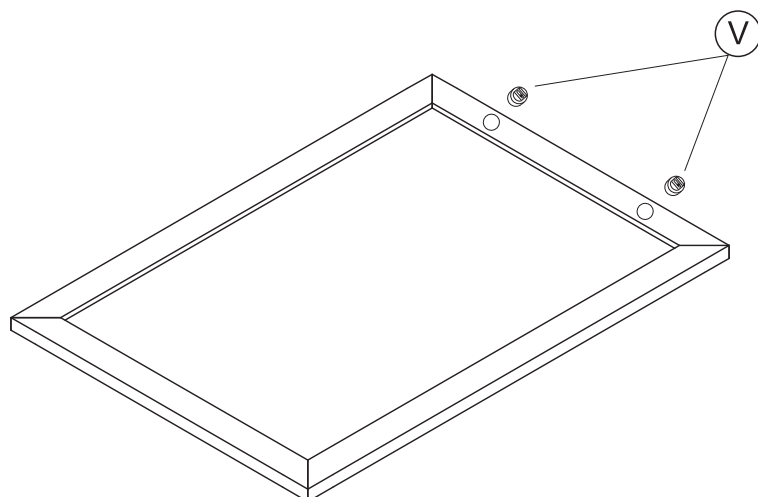

meuble

2/2

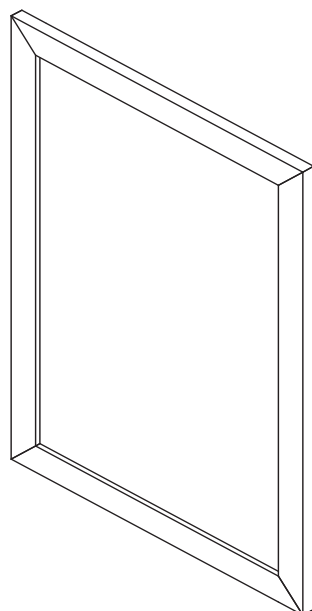

Pripevniť na stenu

Montáž by mala vykonať kvalifikovaná osoba. Pri nesprávnej montáži môže dôjsť k prevrhnutiu alebo pádu nábytku/objektu a k prípadnému zraneniu osôb alebo poškodeniu majetku.

UPOZORNENIE! Skrutky alebo kovanie na upevnenie nábytku/objektu na stenu/strop nie sú súčasťou balenia. Použite skrutky a kovanie, ktoré sú vhodné na použitie do materiálu danej steny/stropu a majú dostatočnú nosnosť. Ak si nie ste istí, obráťte sa na špecializovaného predajcu.