

**avaks**  
nábytok

# REA AMY

## 26

|  |      |
|--|------|
|  | 450  |
|  | 1800 |
|  | 400  |

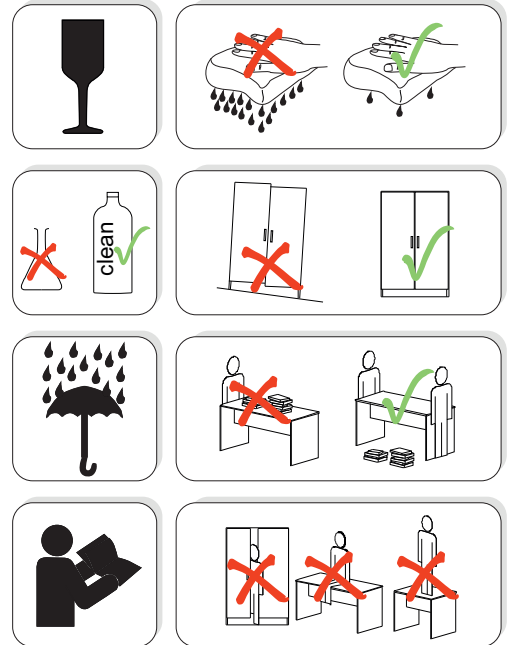
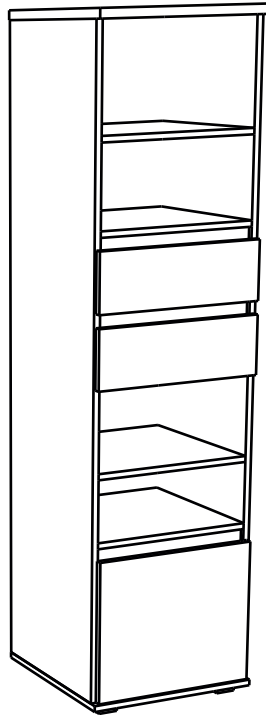

1/1

|                         |               |                      |               |                    |               |                   |      |                           |       |                    |     |                  |      |
|-------------------------|---------------|----------------------|---------------|--------------------|---------------|-------------------|------|---------------------------|-------|--------------------|-----|------------------|------|
| <b>1</b><br>            | <b>3</b><br>  | <b>5</b><br>         | <b>6</b><br>  | <b>9</b><br>       | <b>10</b><br> | <b>11</b><br>     |      |                           |       |                    |     |                  |      |
| kolík<br>8x35           | 22ks          | tiahlo               | 32ks          | excenter           | 32ks          | krytka            | 16ks | skrutka zh<br>3,5x16      | 19ks  | kľazák<br>Herman   | 4ks | klinec<br>1,2x25 | 68ks |
| <b>12</b><br>           | <b>17</b><br> | <b>18</b><br>        | <b>19</b><br> | <b>20</b><br>      | <b>21</b><br> | <b>22</b><br>     |      |                           |       |                    |     |                  |      |
| euroskrutka<br>6,3x11   | 12ks          | podperka<br>sklo 5x5 | 8ks           | skrutka zh<br>5x25 | 8ks           | konfirmát<br>7x50 | 14ks | výs. kolieskovy<br>350 mm | 3páry | skrutka zh<br>4x25 | 2ks | Pd8              | 2ks  |
| <b>28</b><br>           |               |                      |               |                    |               |                   |      |                           |       |                    |     |                  |      |
| bezpečnostný<br>uholník | 1ks           |                      |               |                    |               |                   |      |                           |       |                    |     |                  |      |

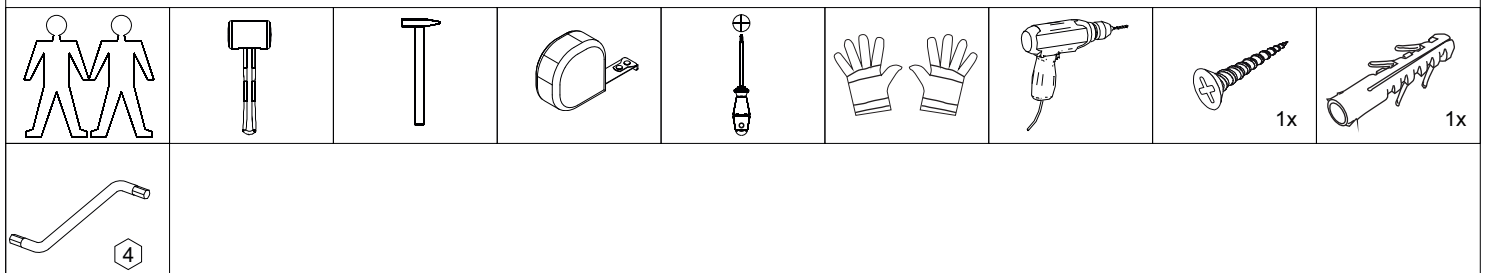

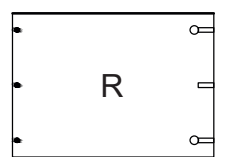
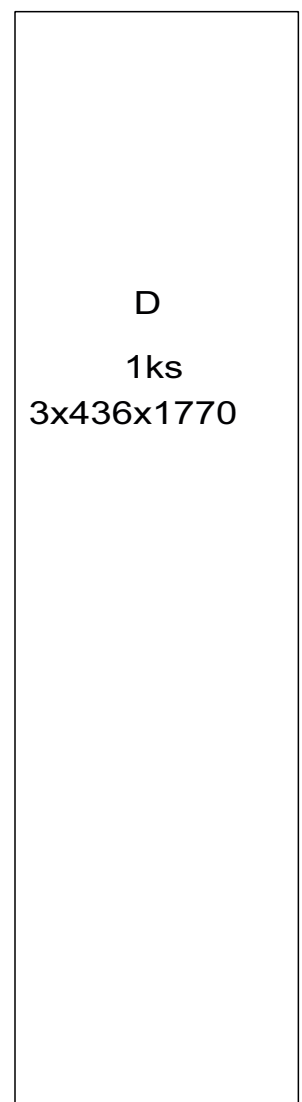
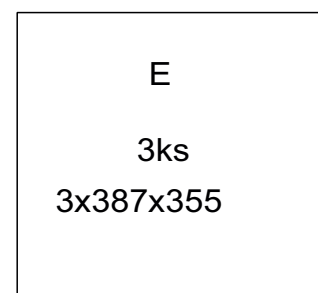
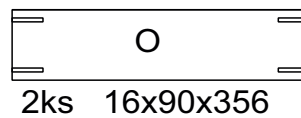
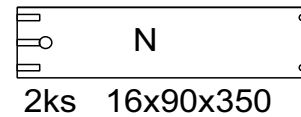
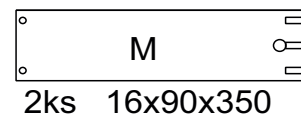
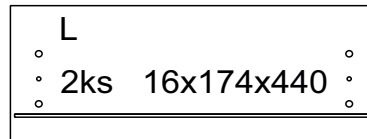
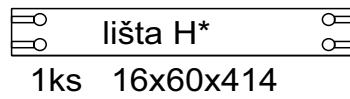
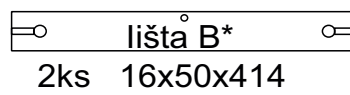
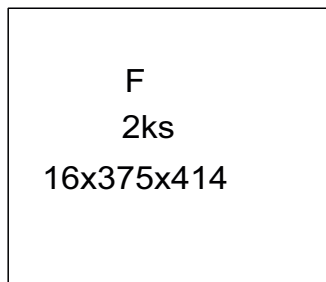
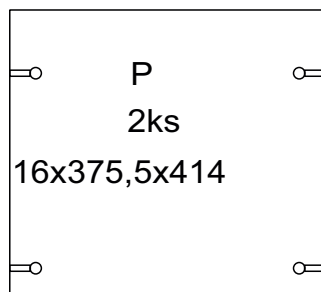
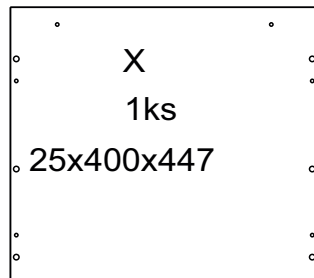
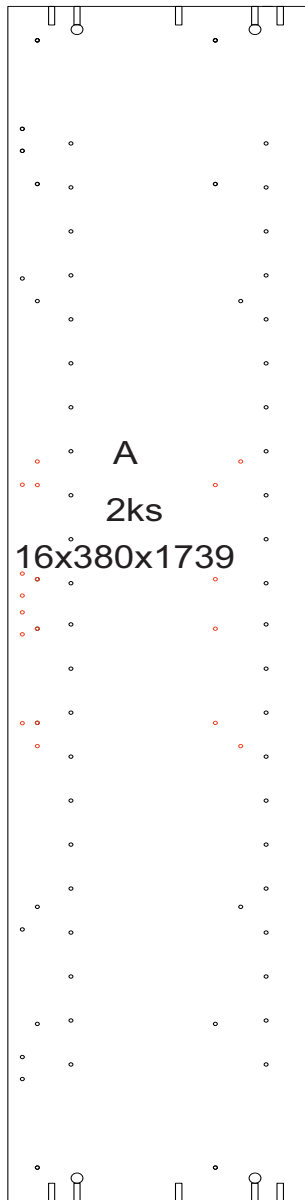

1ks 16x250x350



1ks 16x250x350

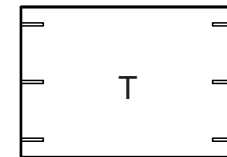

1ks 16x250x356

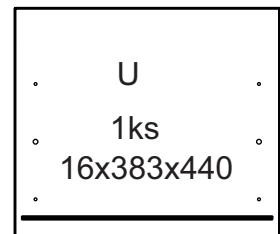

1

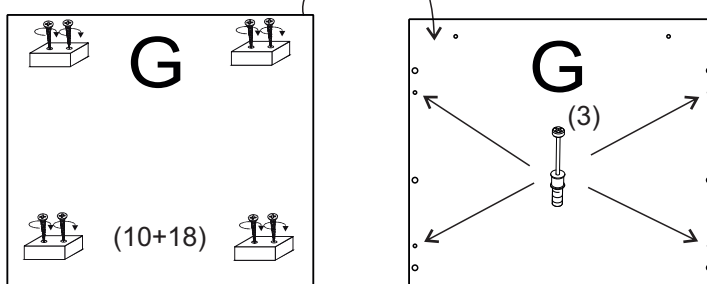

2

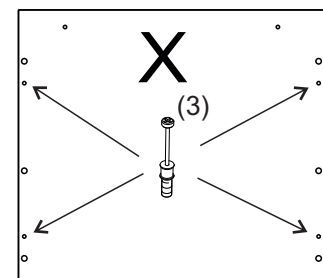

3.

A

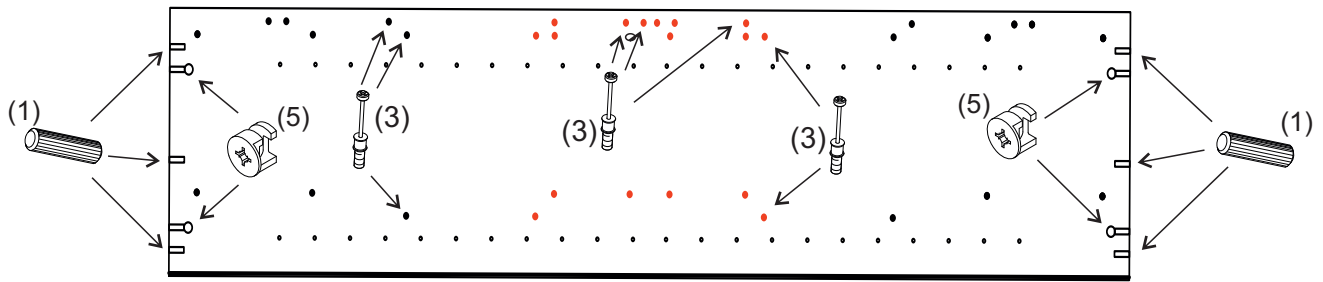

A

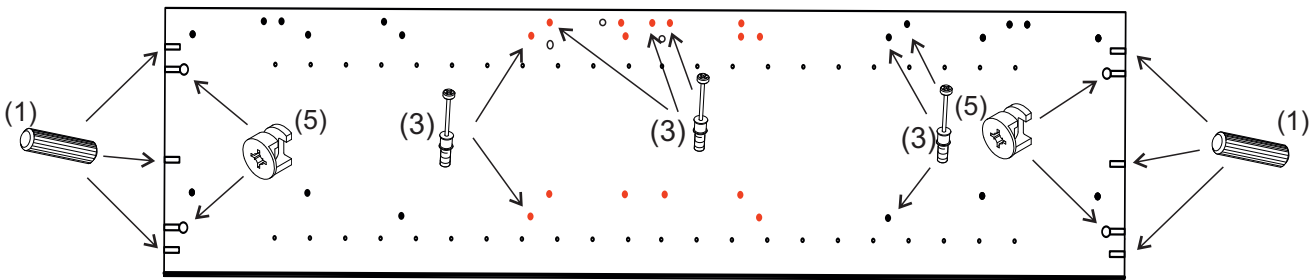

4

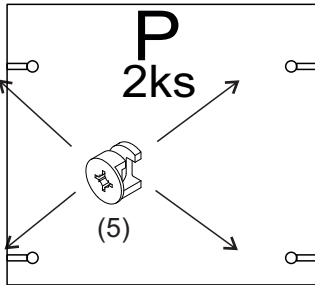

6

L-2ks

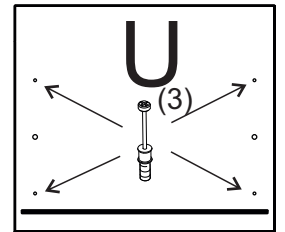
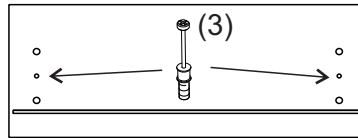

M-2ks

N-2ks

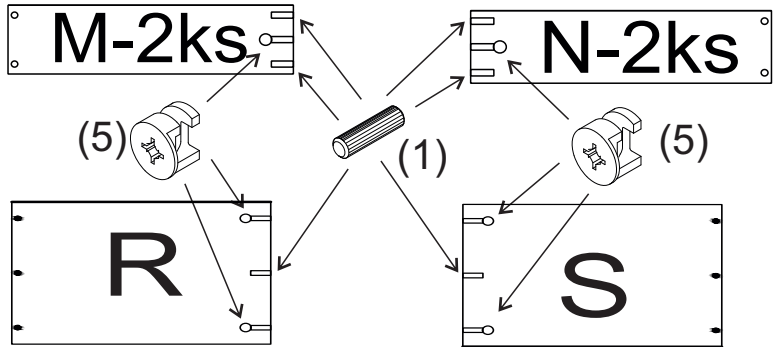

5

2ks-lišta B\*

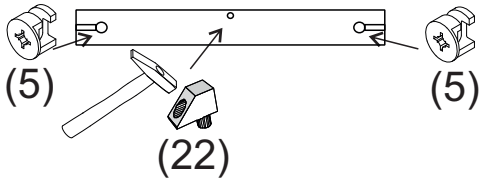

7

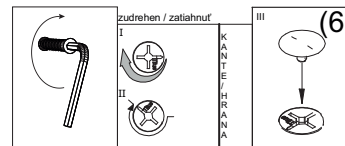

lišta H\*

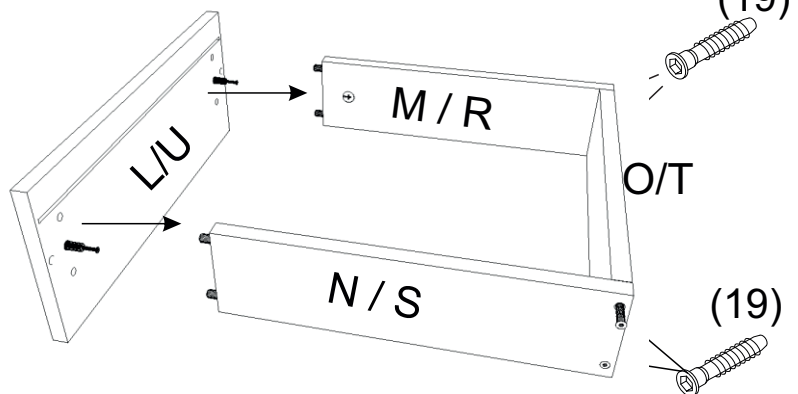
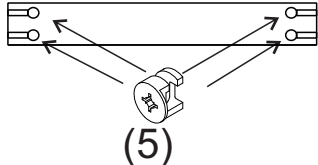

8

a=b

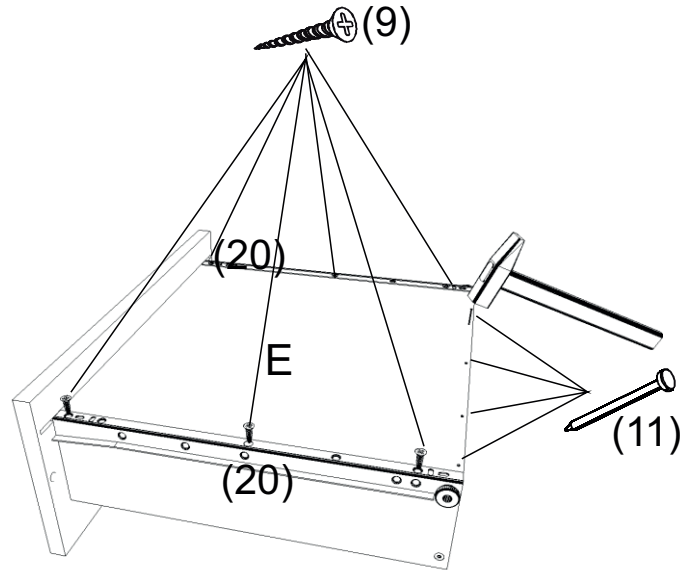
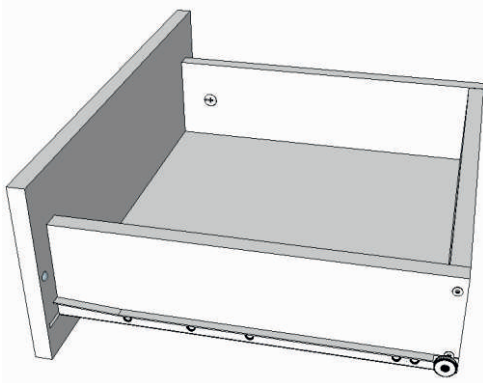
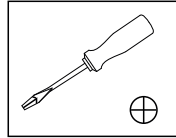
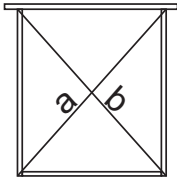

9

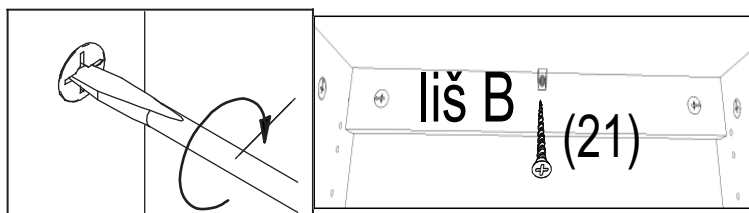
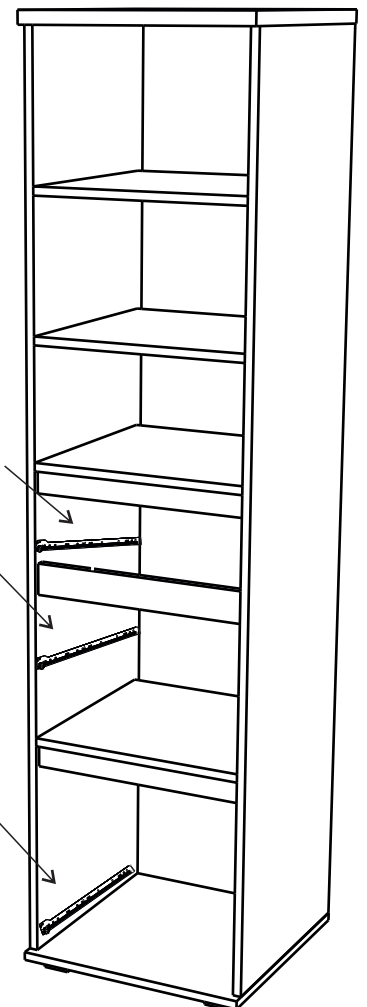
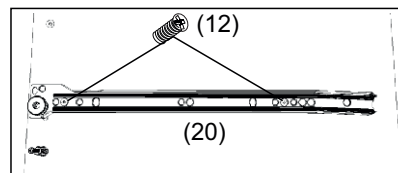
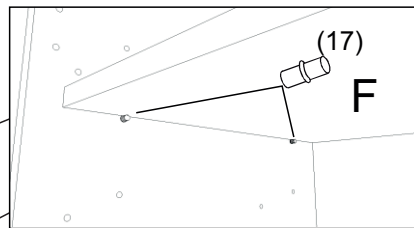
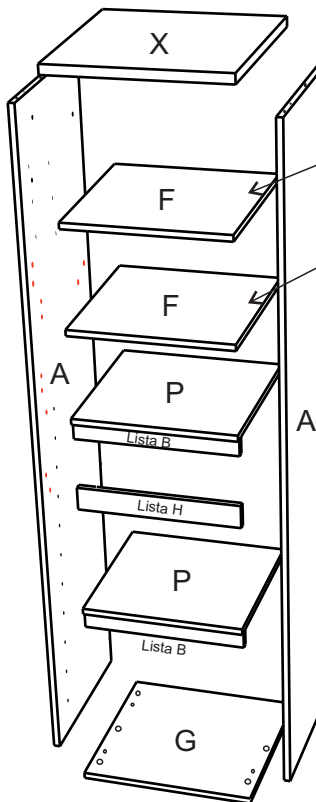

10

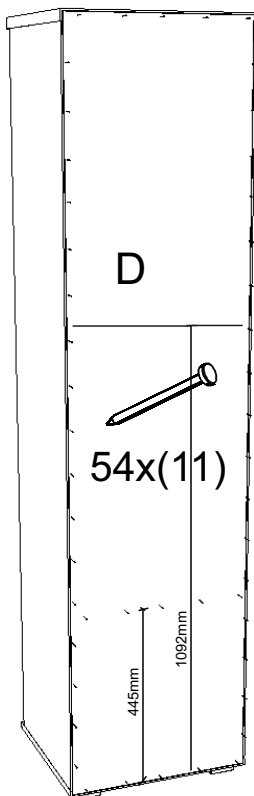
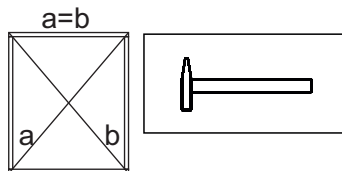

11

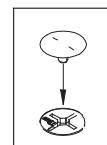
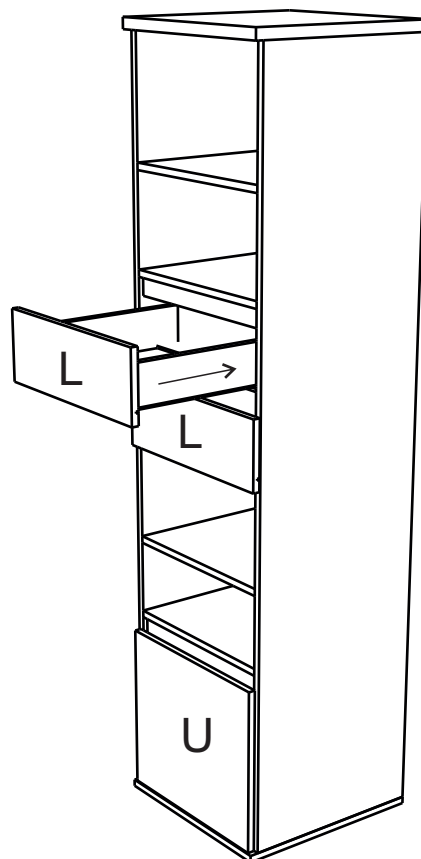

12.

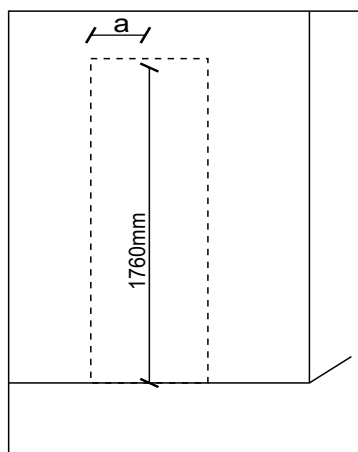
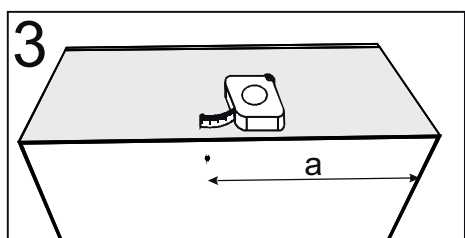
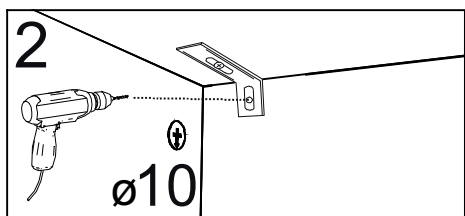
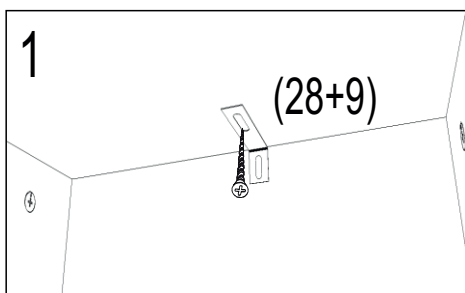

(30\*)

