

A	B	C	D
1	S383-0018	1272	394
2	S383-0019	1272	496
3	S383-1023	1280	385
4	S383-1024	1280	385
5	S383-1025	1280	382
6	S383-2017	900	403
7	S383-2018	900	403
8	S383-3009	477	382
9	S383-3010	476	380
10	S383-3012	377	382
11	S383-3013	376	380
12	S383-5004	475	350
13	S383-9306	1305	893

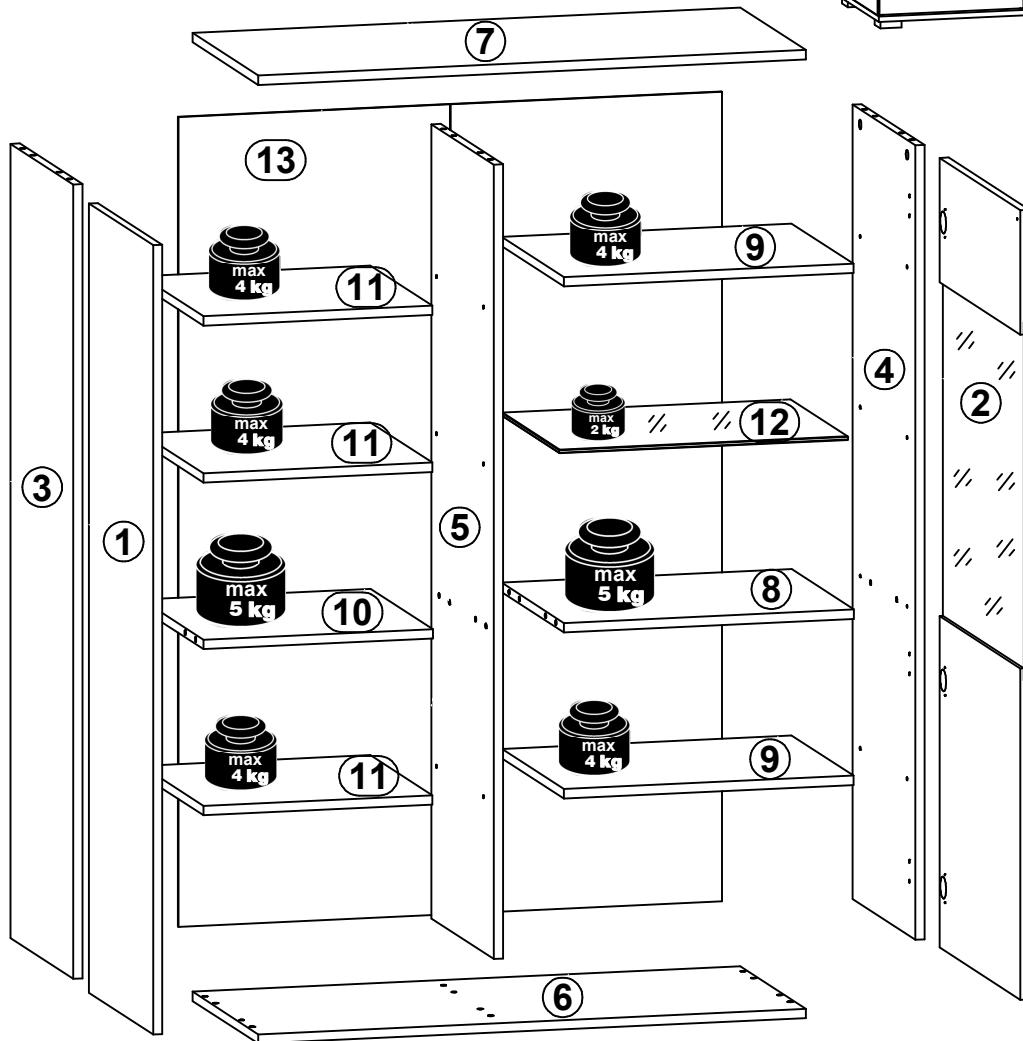

6x a44	6x b19	1x c409 128mm	20x d1 Ø5x17 mm	4x d3 Ø5x17 mm	6x e1 Ø7x50 mm	10x e3 Ø6x13 mm	20x f1 Ø8x30 mm	5x k82\1
5x k82\2	65x l1	4x o21 silikon	12x p51 Ø3,5x15 mm	2x p93 Ø4x13 mm	14x r1 Ø15x12 mm #16	2x r10	10x r42 20\11	1x z28\1
1x z28\2 82x9,5\6,5mm	1x z28\3 20x20\1,5 mm	3x z28\4 Ø3x12mm	6x s2 Ø16	1x z1 4 mm	1 n26\1	1x p38 Ø3,5x16 mm		

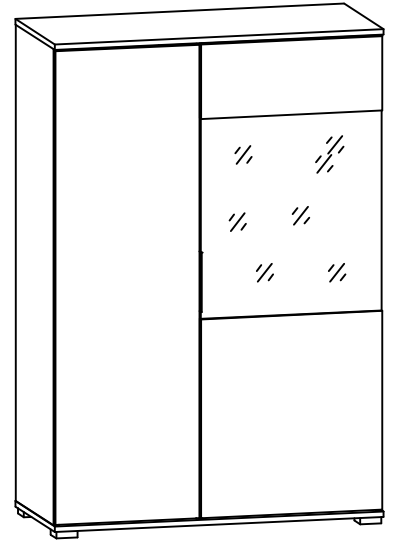
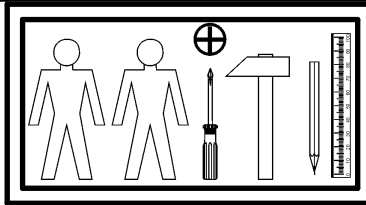
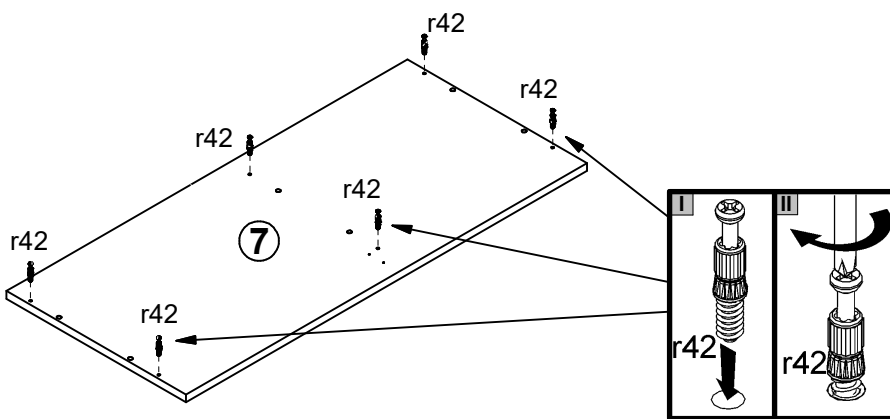
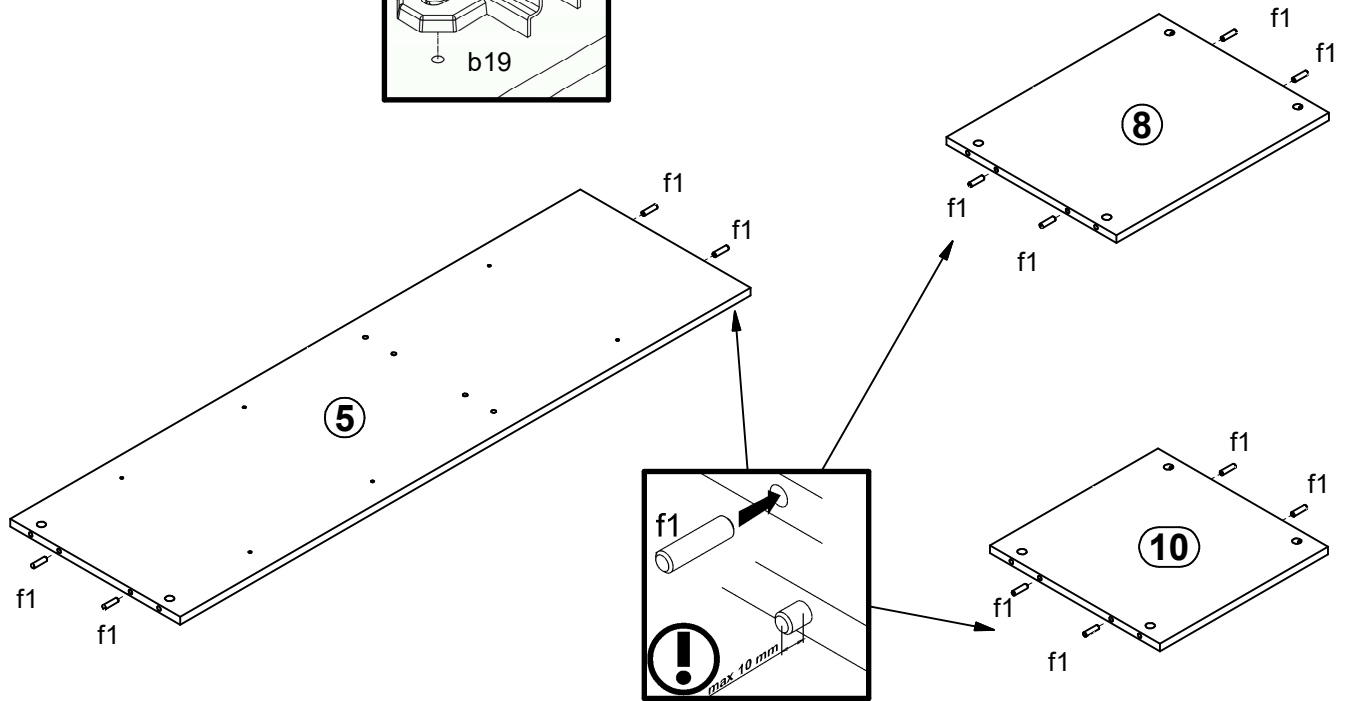
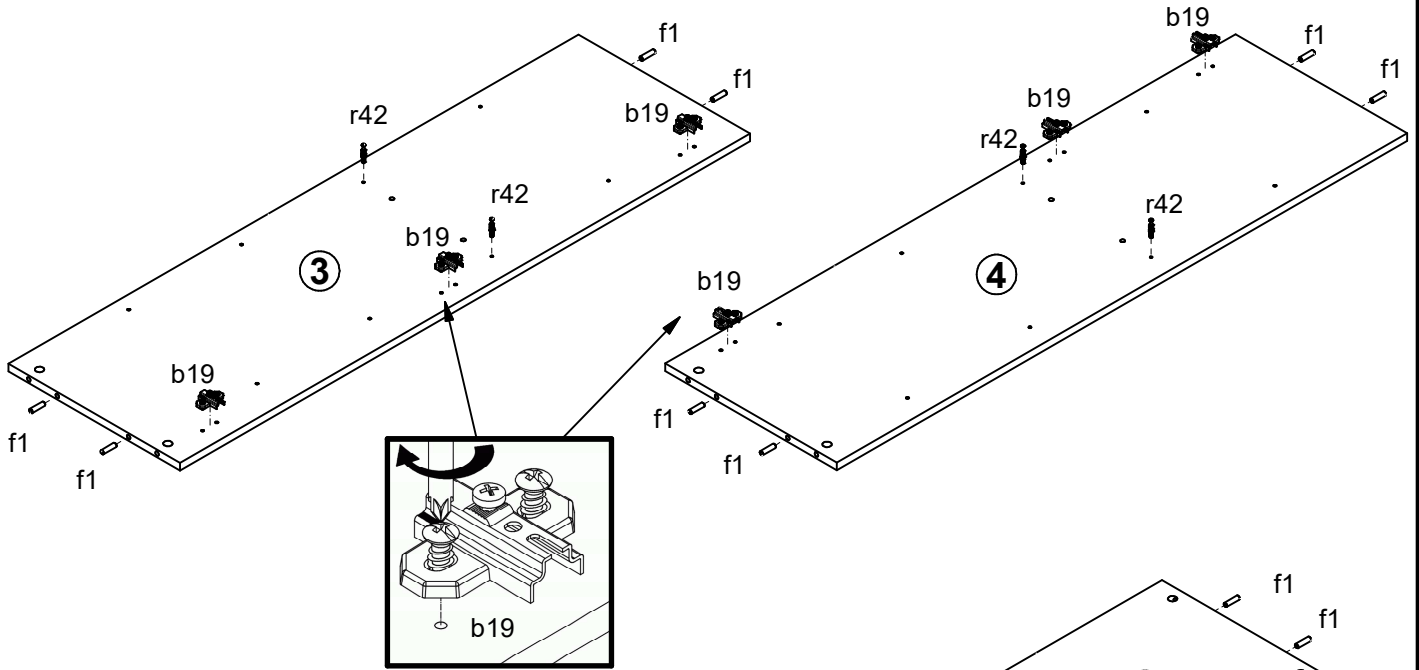

2

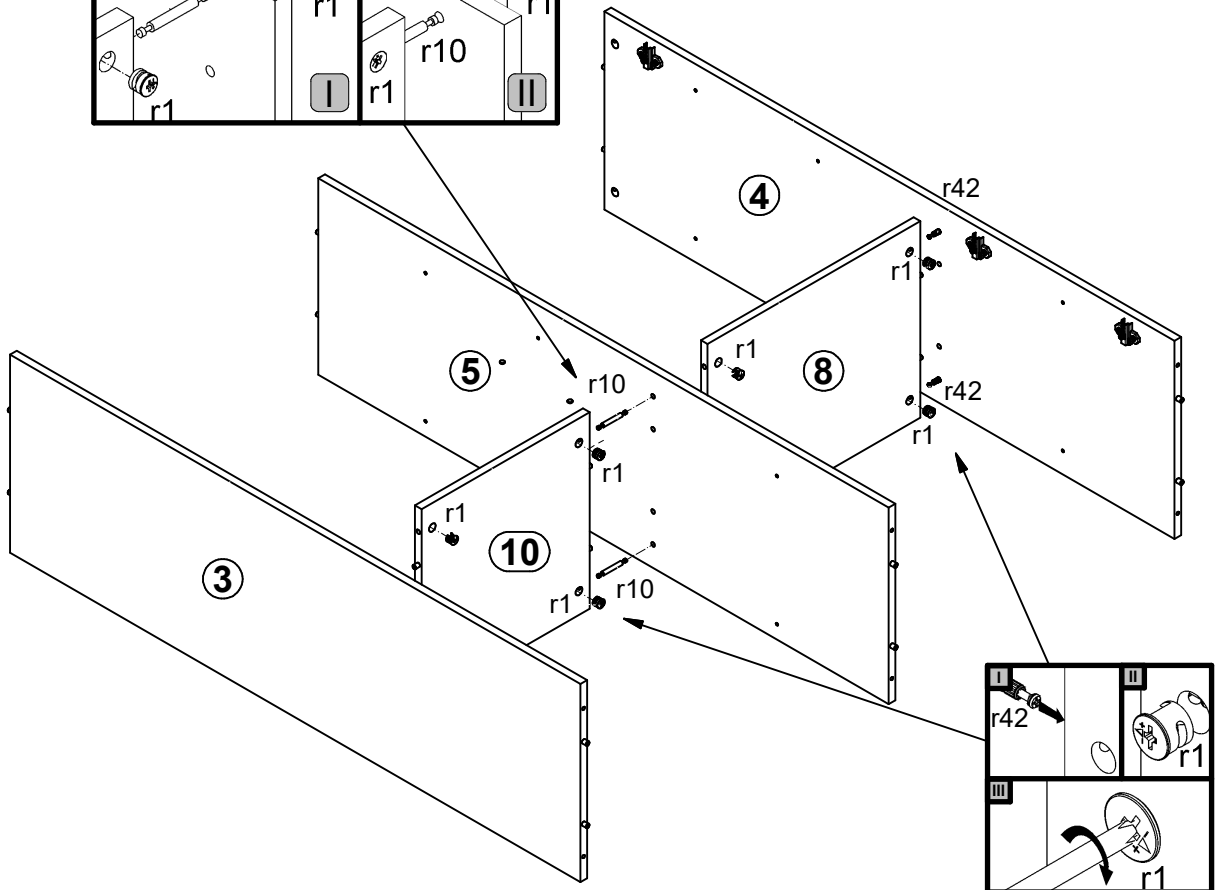
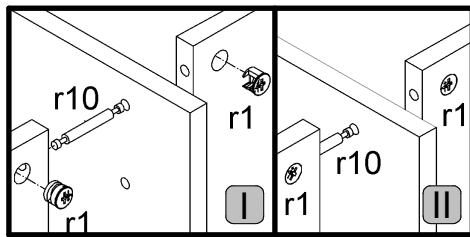

3

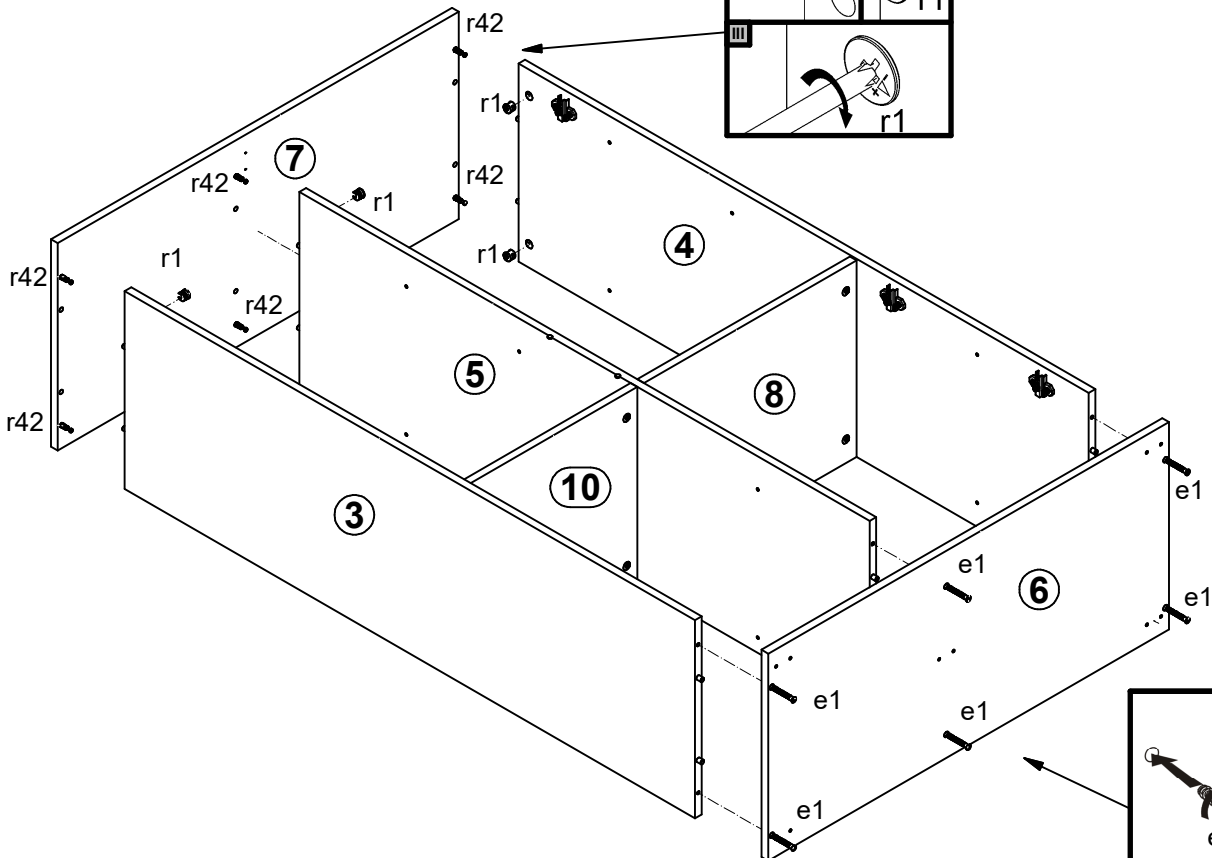
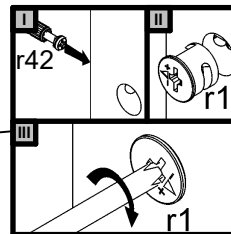

4

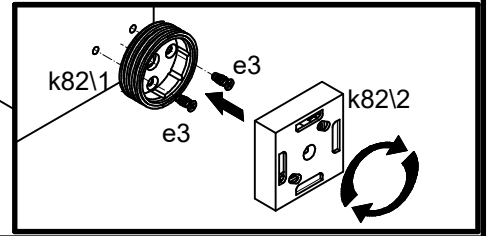
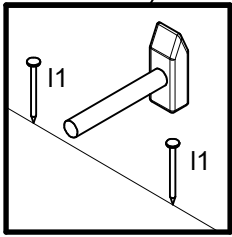
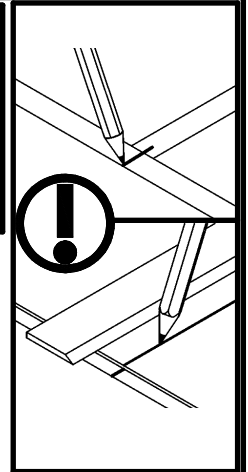
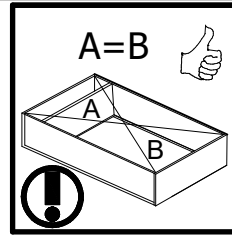
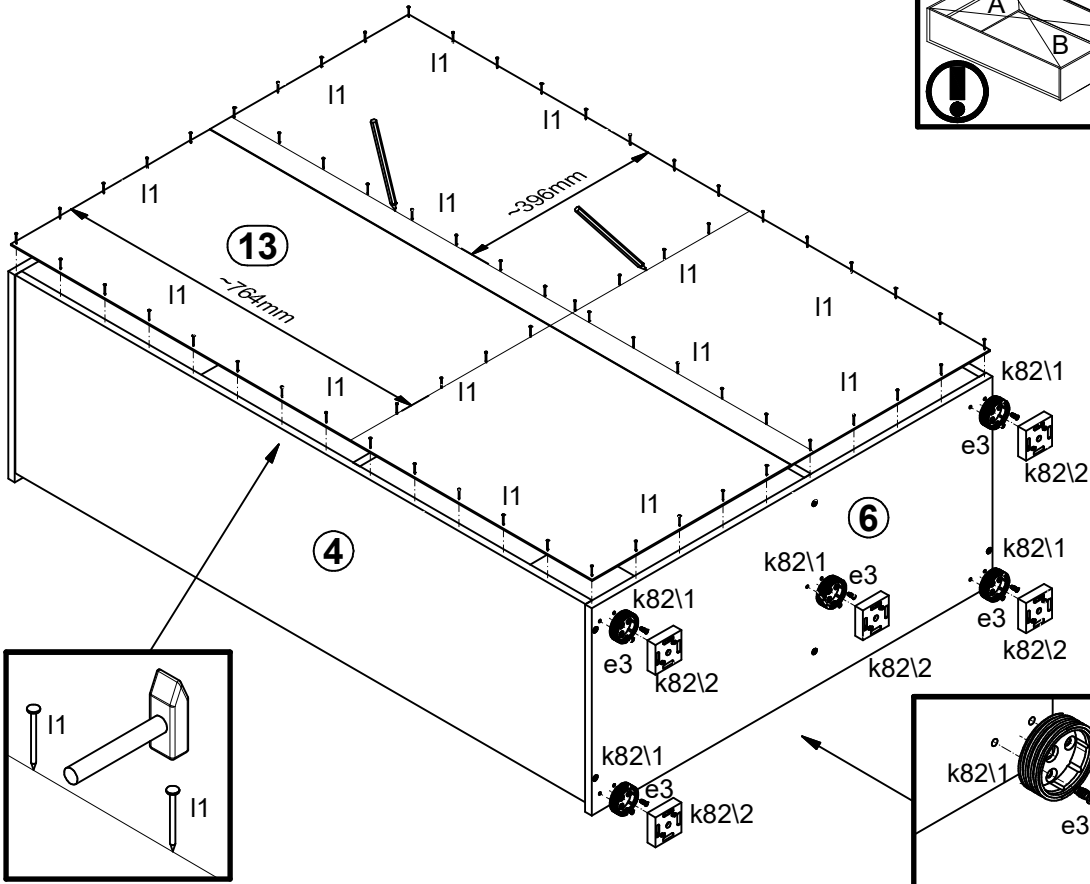

5

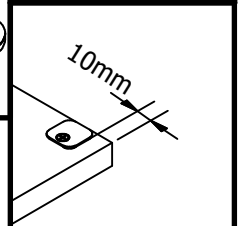
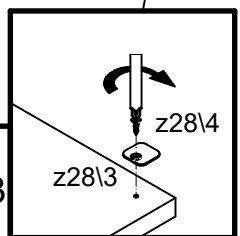
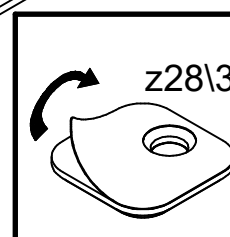
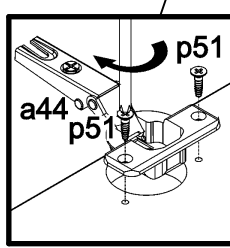
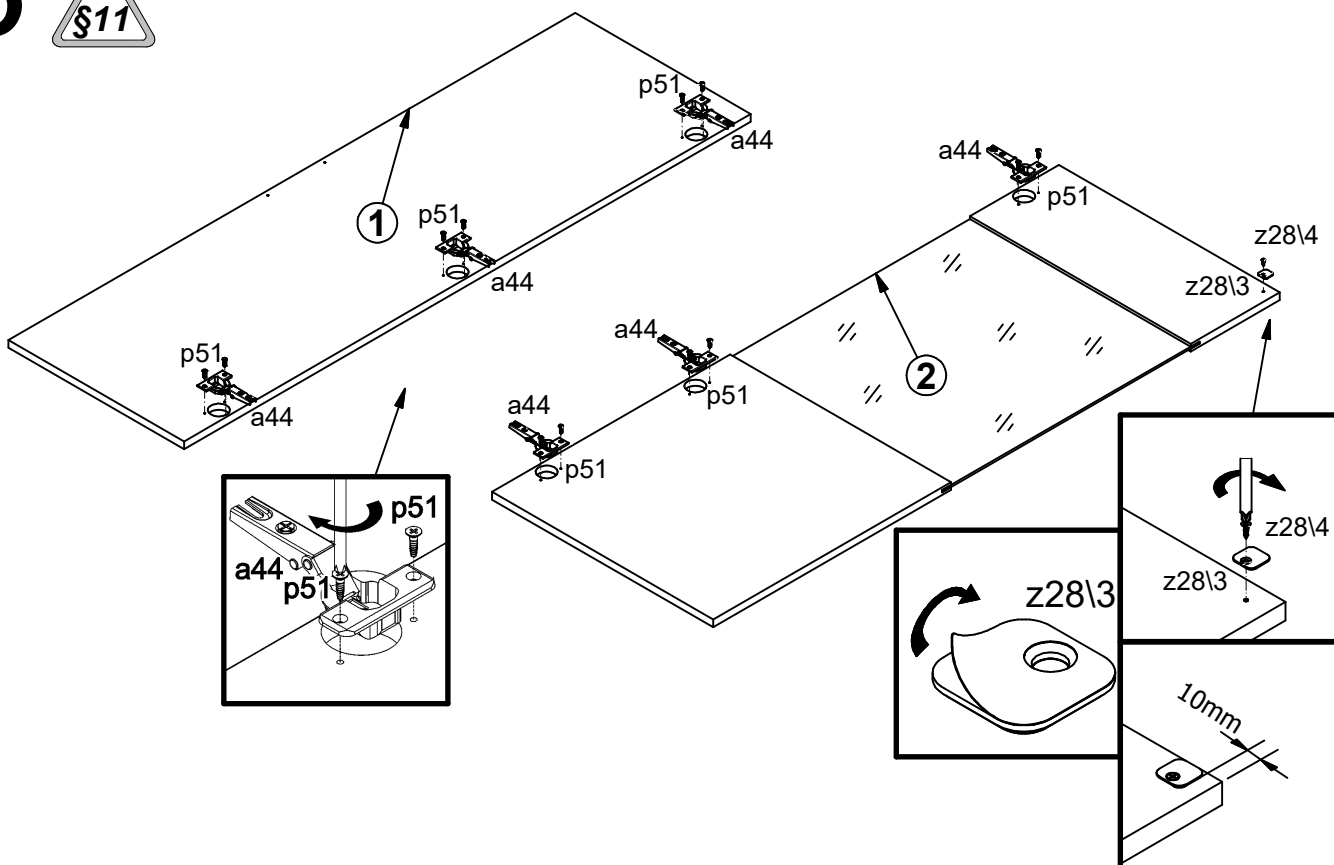

6

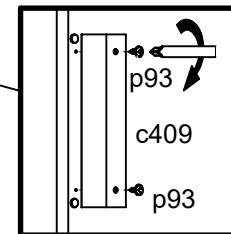
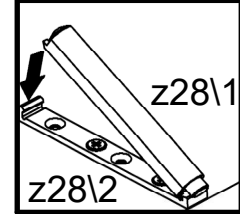
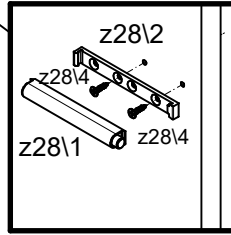
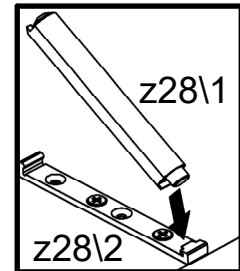
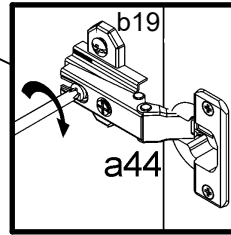
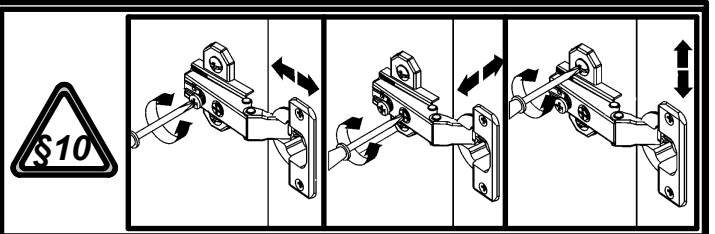
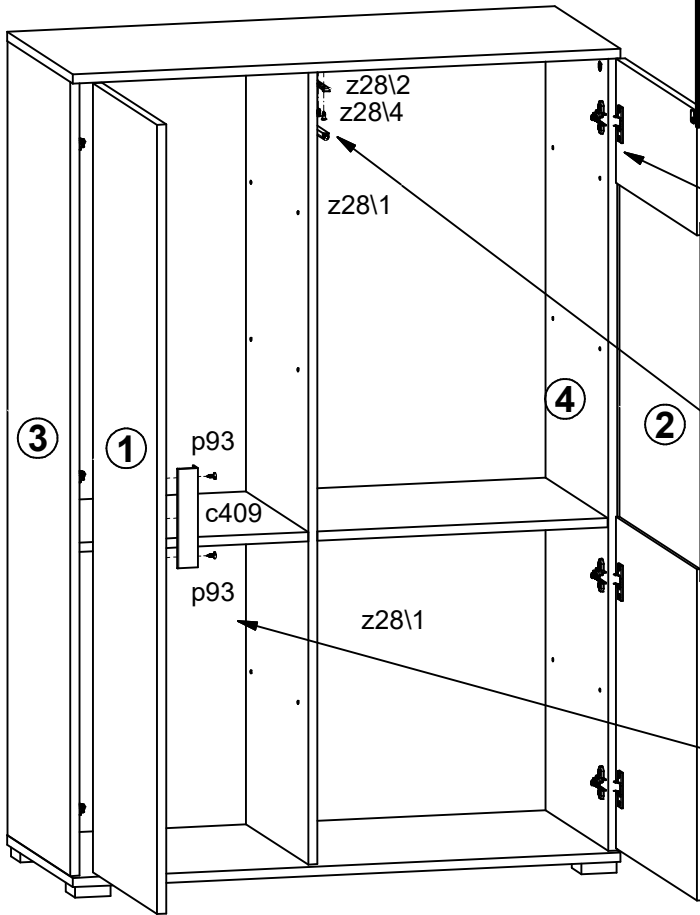

7

