

A	B	C	D	
1	S404-0003	518	446	3/3
2	S404-0004	518	446	3/3
3	S404-0006	446	120	3/3
4	S404-0007	446	120	3/3
5	S404-0008	446	120	3/3
6	S404-0009	446	120	3/3
7	S404-1029	1558	428	1/3
8	S404-1030	1558	428	1/3
9	S404-1031	768	402	1/3
10	S404-2008	1041	454	2/3
11	S404-3001	1009	428	2/3

A	B	C	D	
12	S404-3002	1008	407	2/3
13	S404-3014	1009	393	2/3
14	S404-4001	1009	60	2/3
15	S404-4002	1009	160	2/3
16	S404-5003	900	70	2/3
17	S404-5004	900	70	2/3
18	S404-5022	1558	70	1/3
19	S404-5023	1558	70	1/3
20	S404-5051	495	398	2/3
21	S404-5055	588	446	3/3
22	S404-9307	1486	1019	1/3

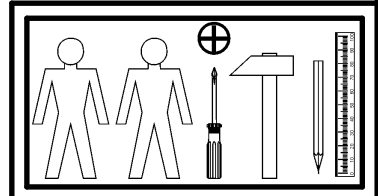

8x a132	4x a133	8x b43	4x Ø5x17 mm d1	16x Ø5x17 mm d3	1x d36	11x d37	2x Ø7x50 mm e1	16x Ø6,3x13 mm e2
16x Ø5x12 mm e41	3x Ø7x24 mm e45	24x Ø8x30 mm f1	2x Ø8x20 mm f13	4x k1	10x 1,4x20 mm l1	10x l2	16x Ø5,3/Ø6,3x4,8 mm o54	46x Ø3,5x16 mm p38
16x Ø3,5x15 mm p51	22x Ø15x12 mm #16 r1	22x 20/11 r42	8x Ø16 s2	1x 4 mm z1			1x n26/1	1x Ø3,5x16 mm p38

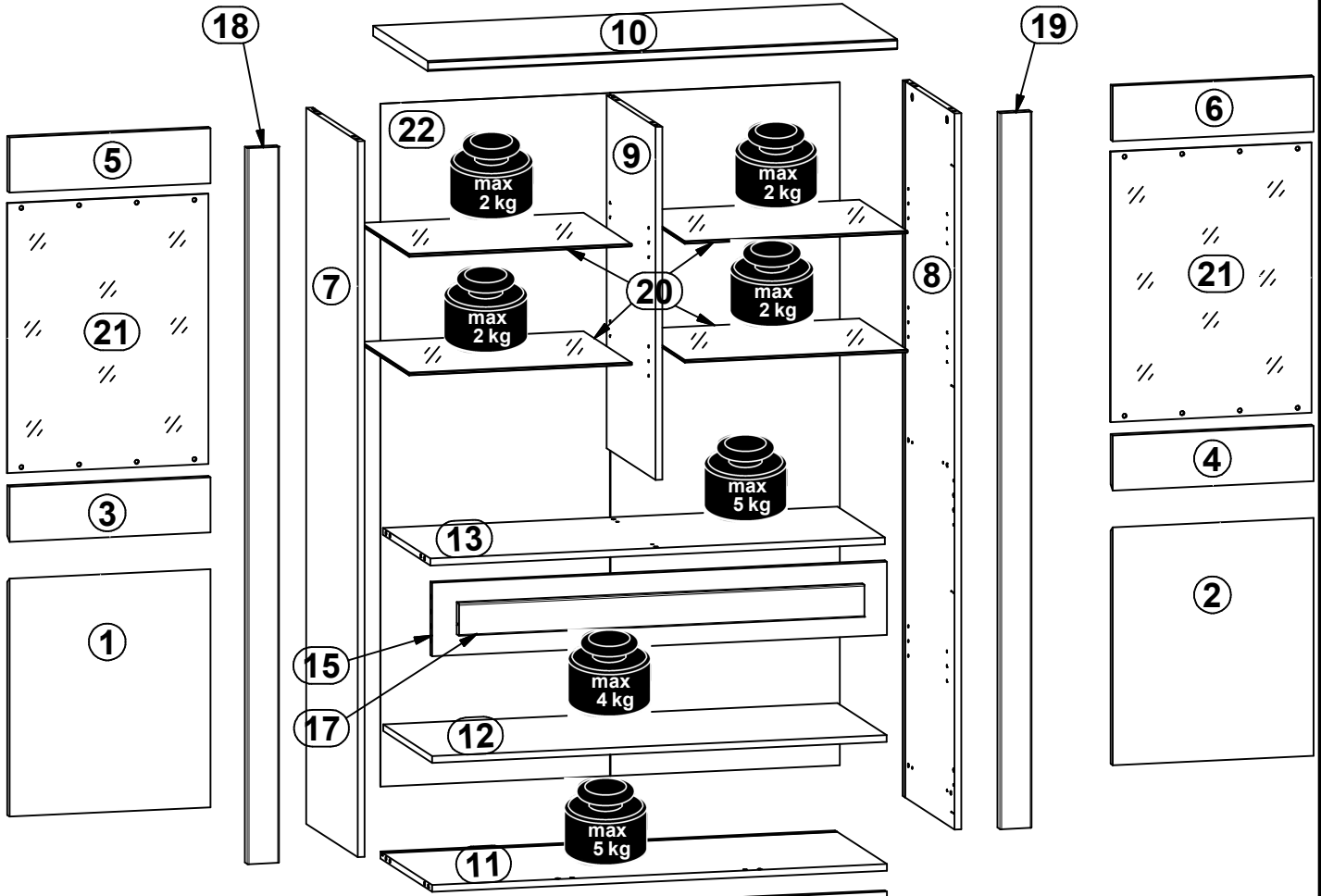
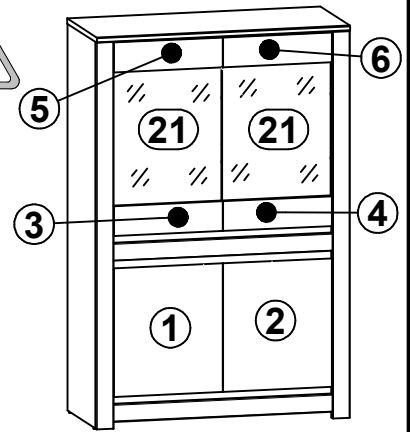
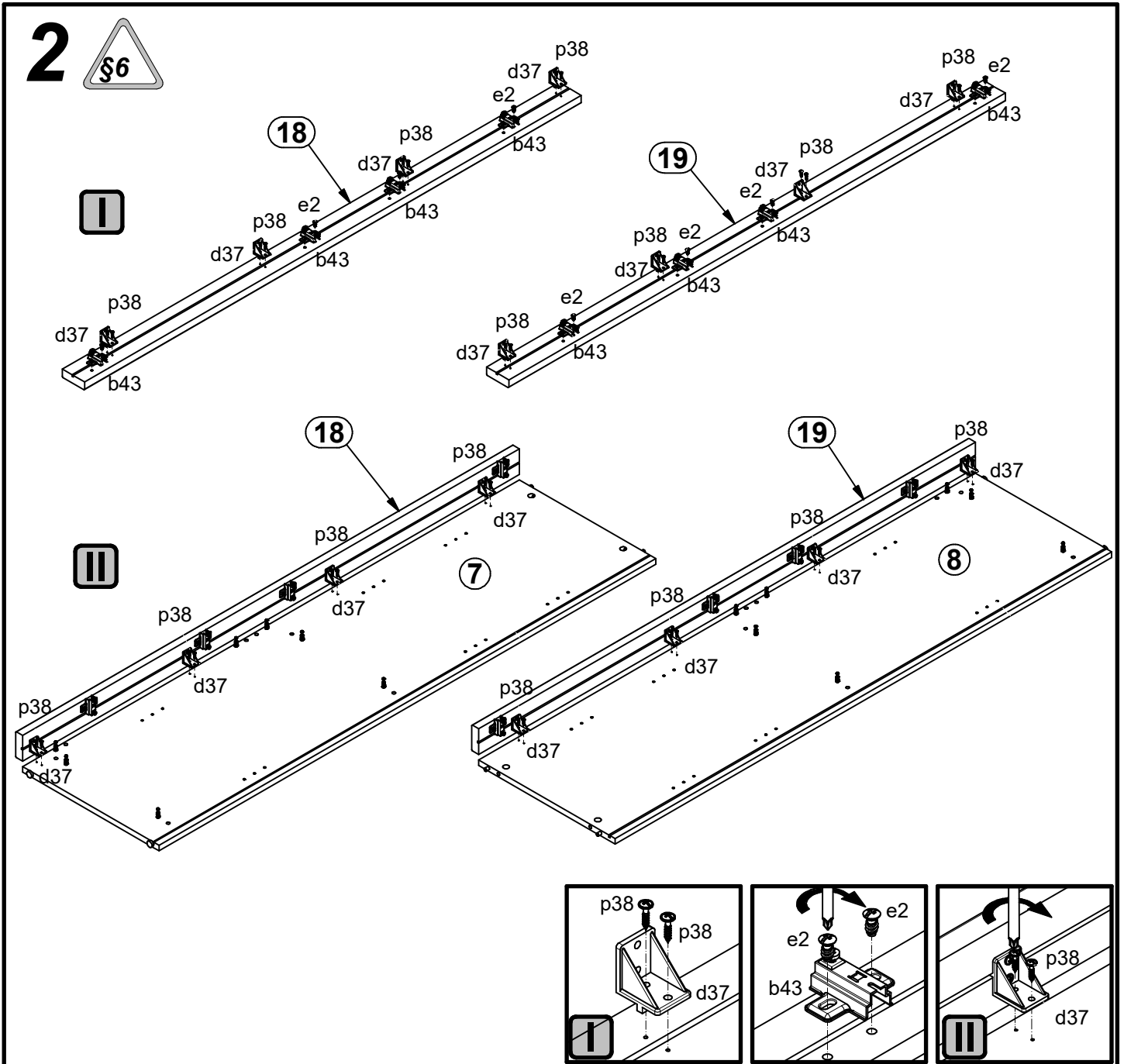
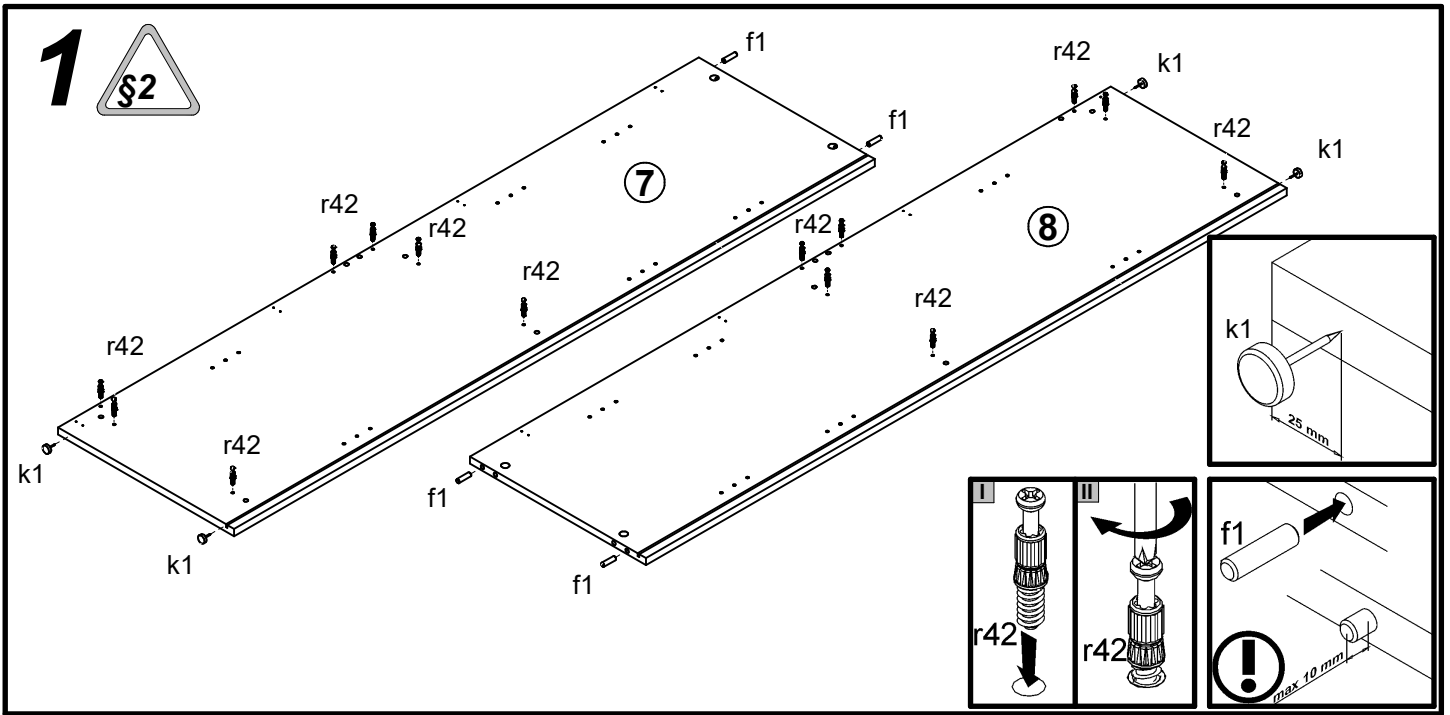

3

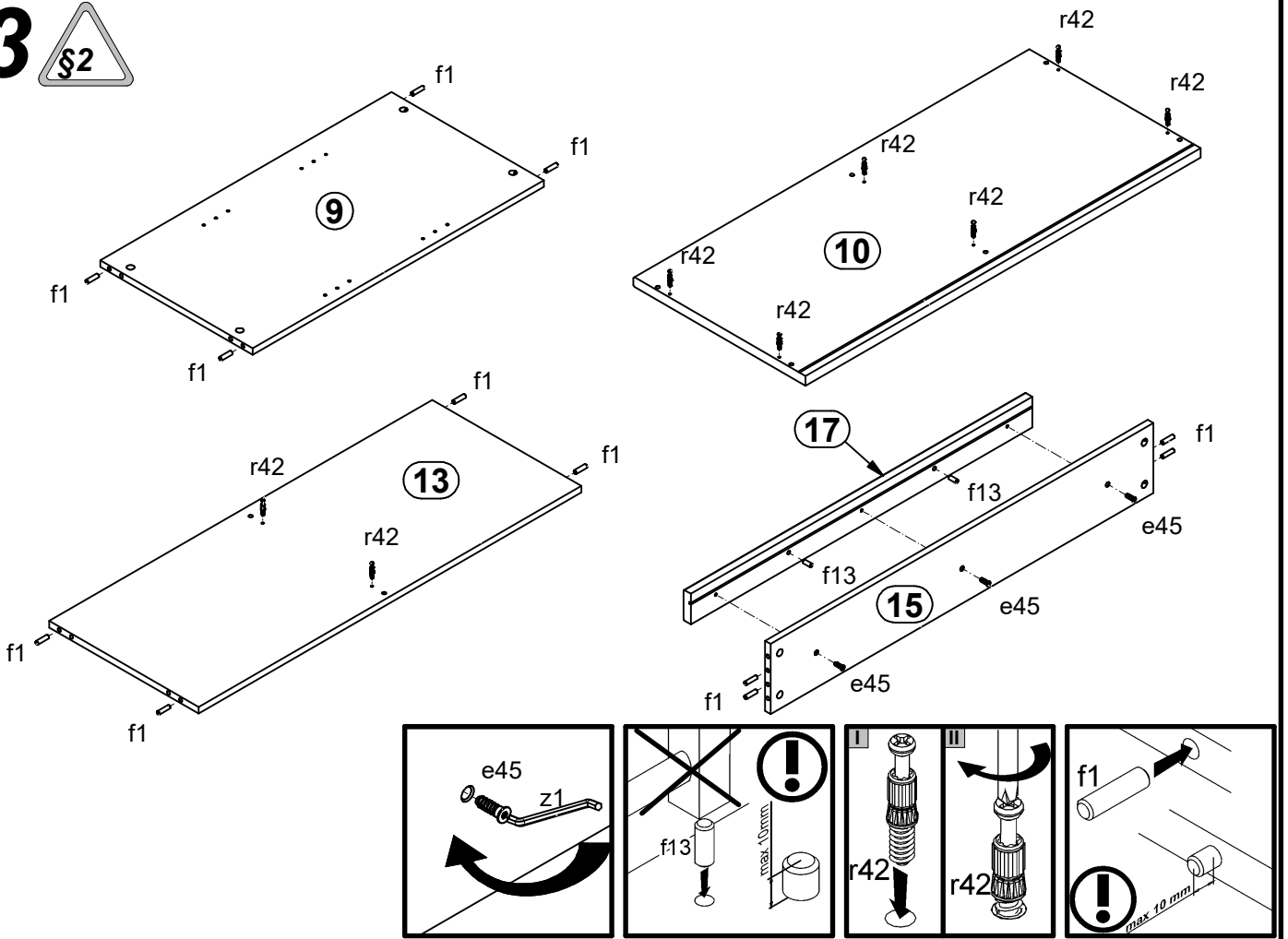

4

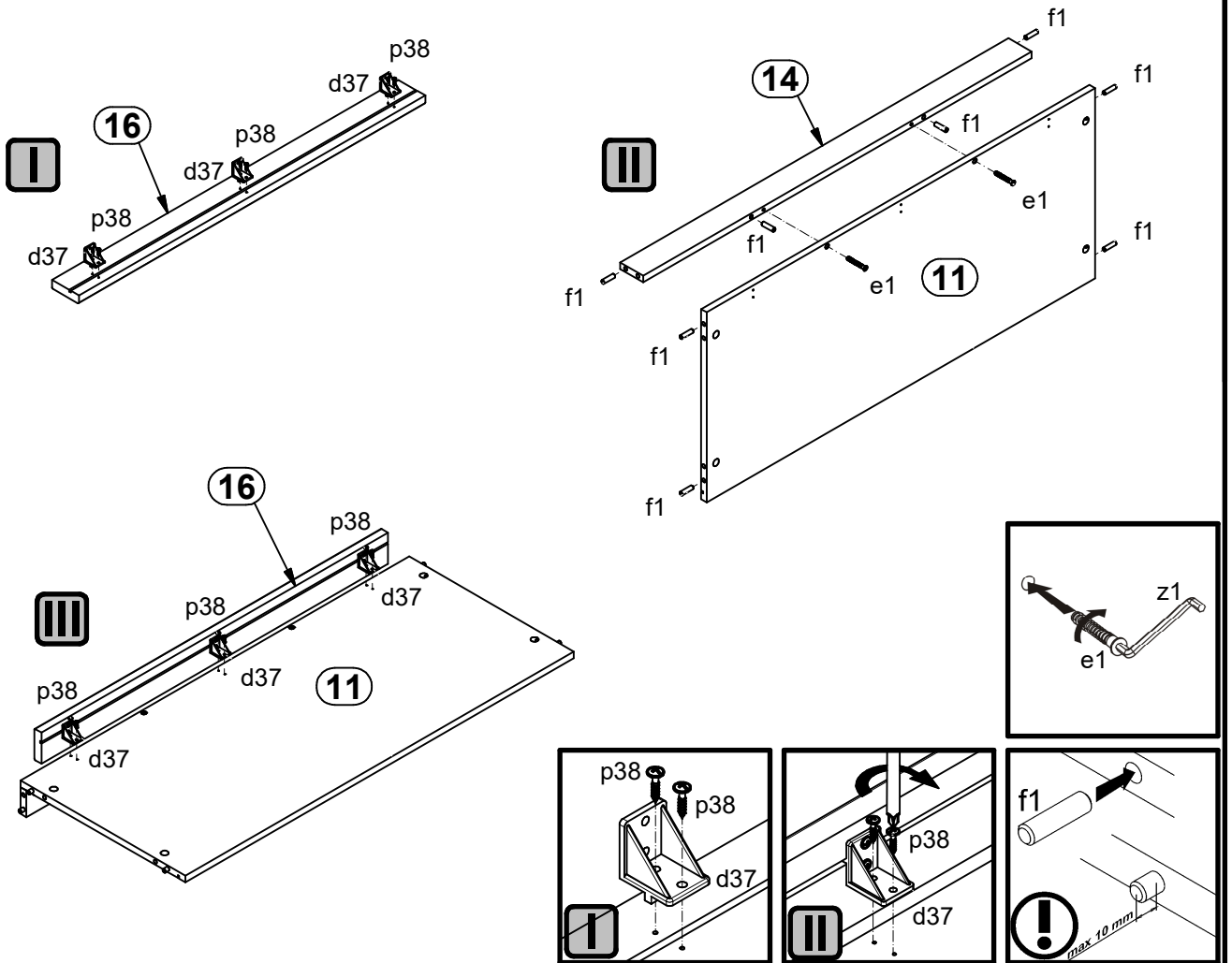

5

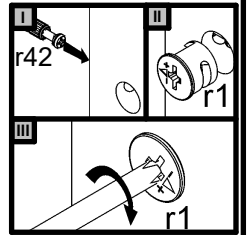
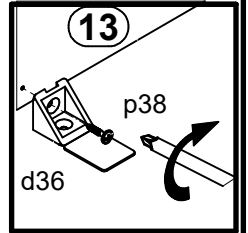
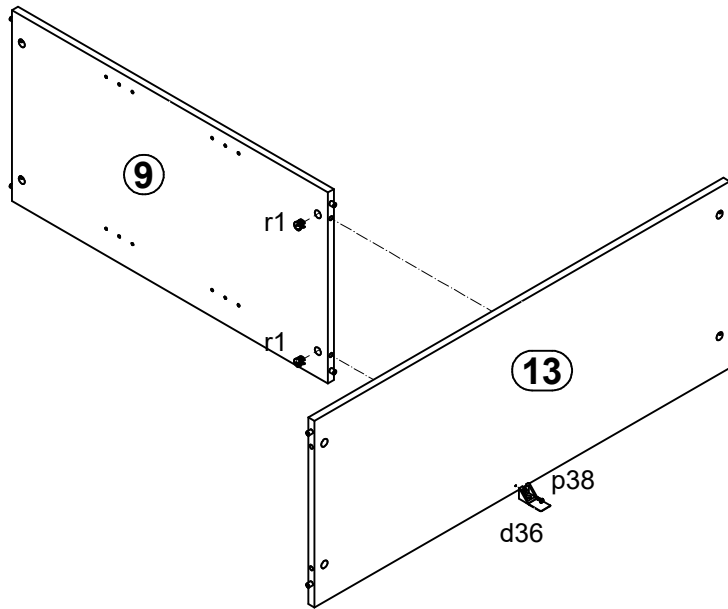

6

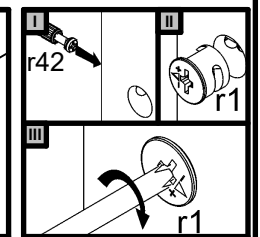
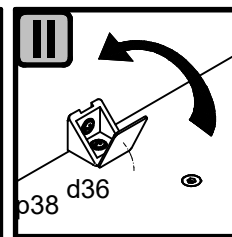
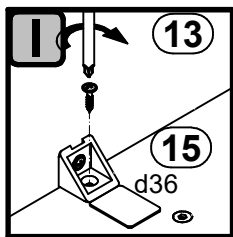
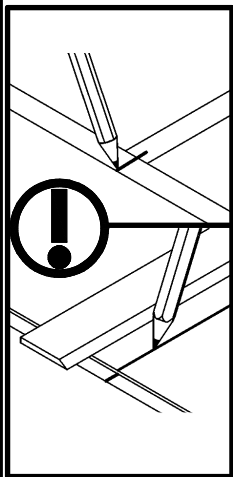
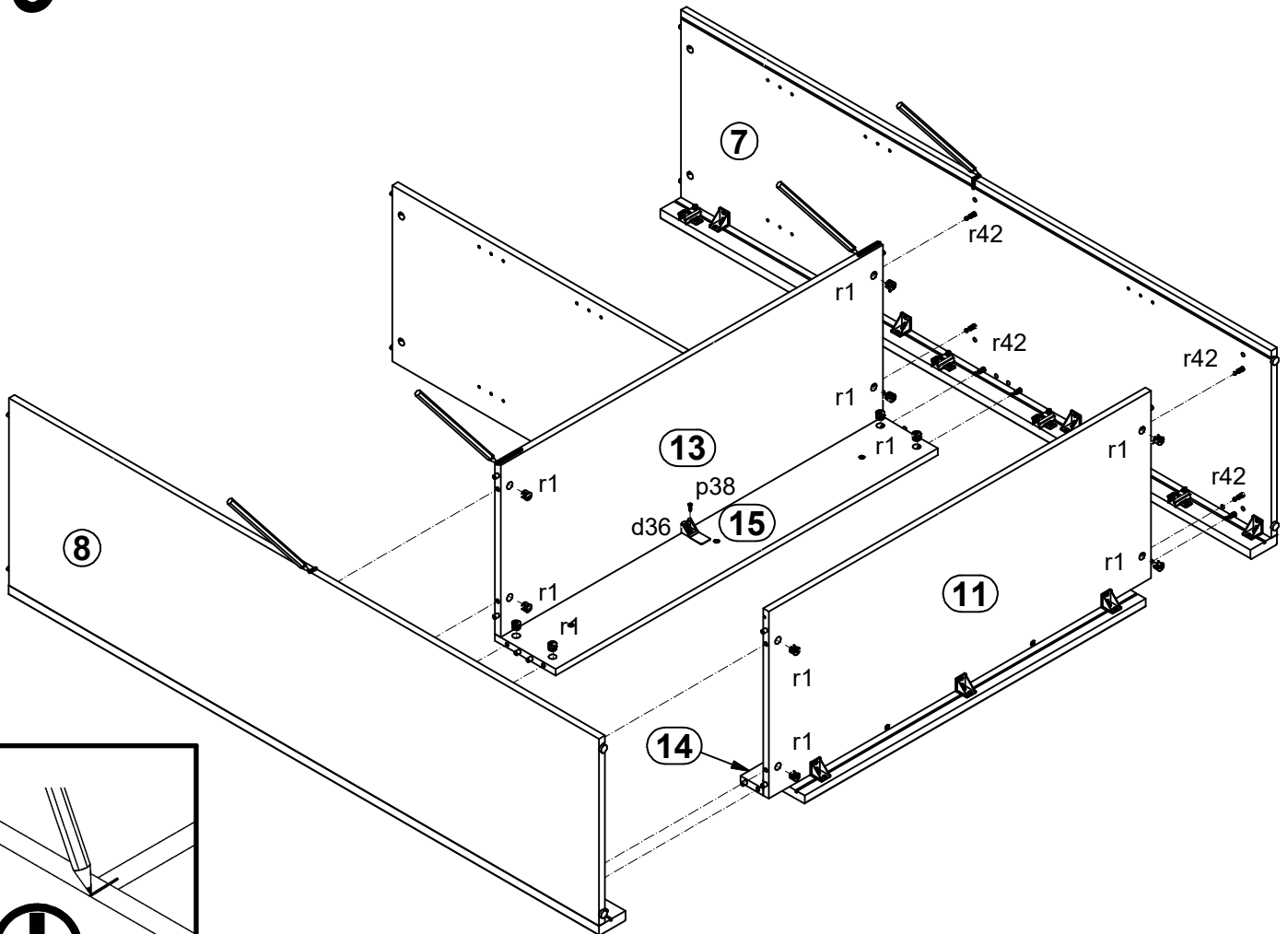

7

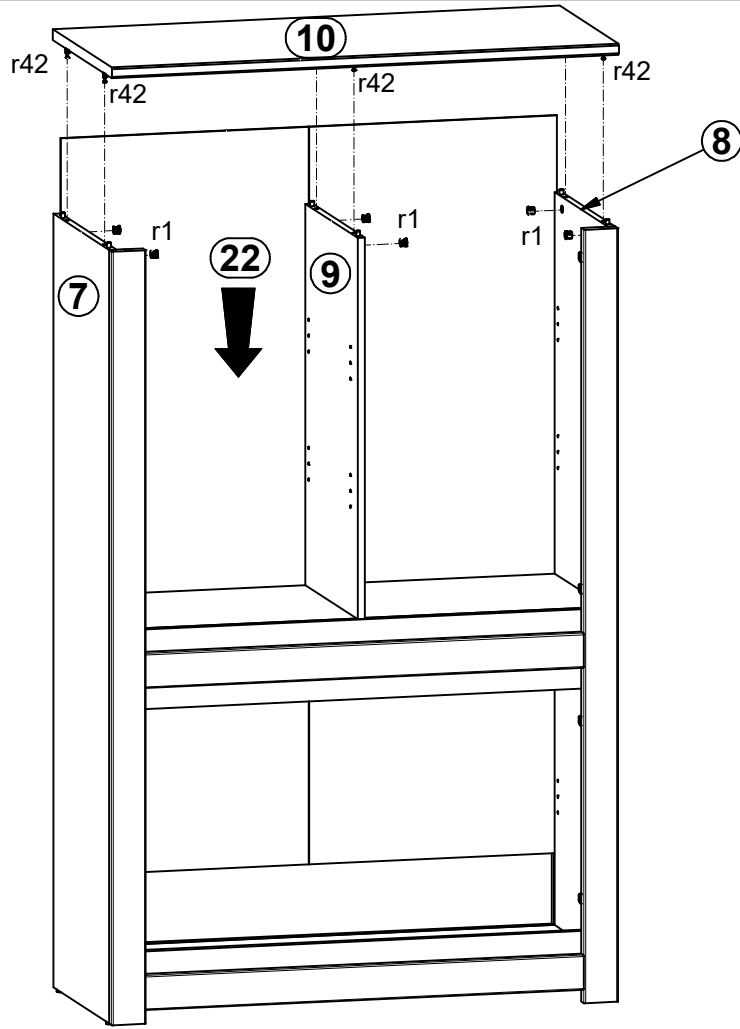

8

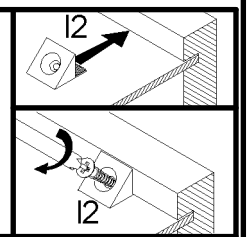
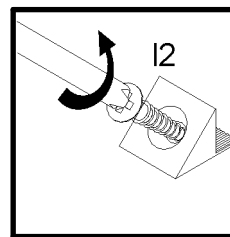
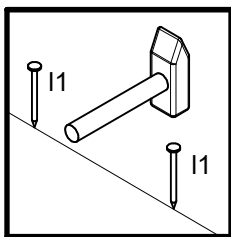
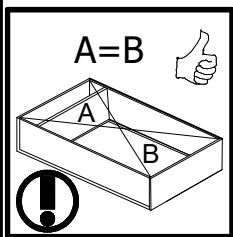
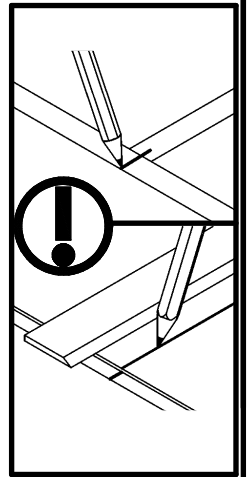
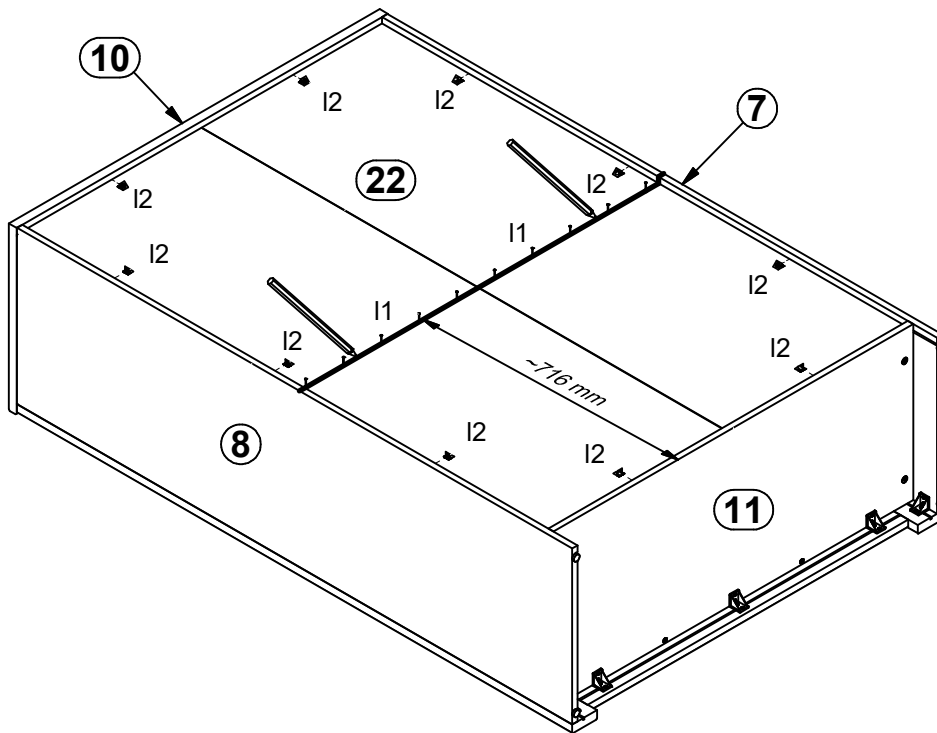

9

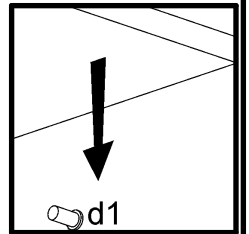
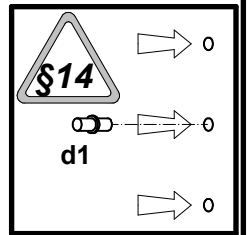
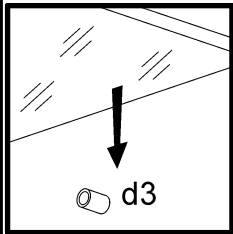
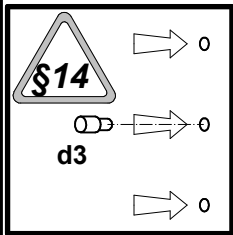
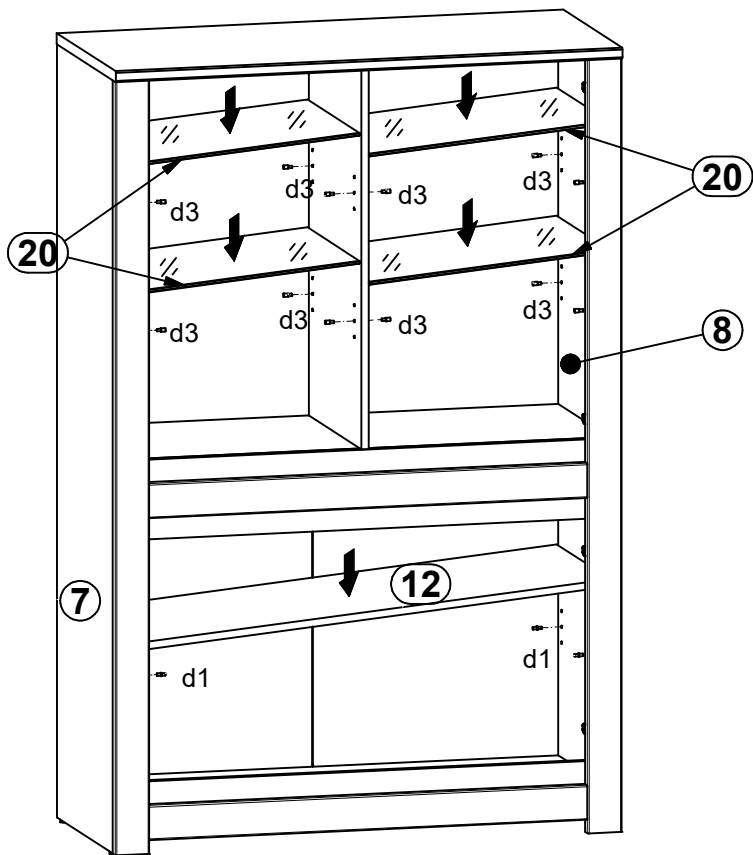

10

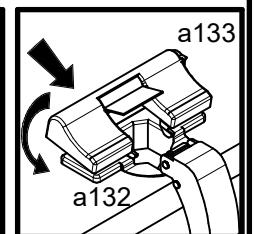
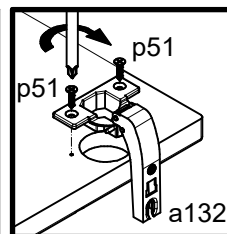
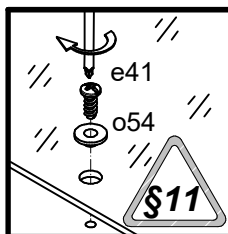
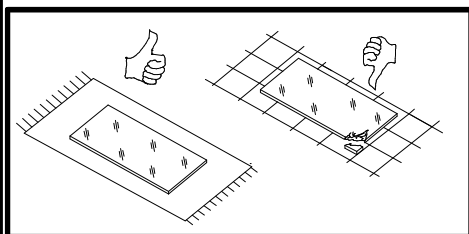
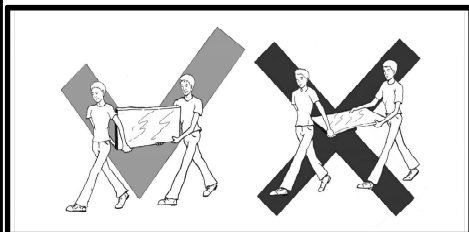
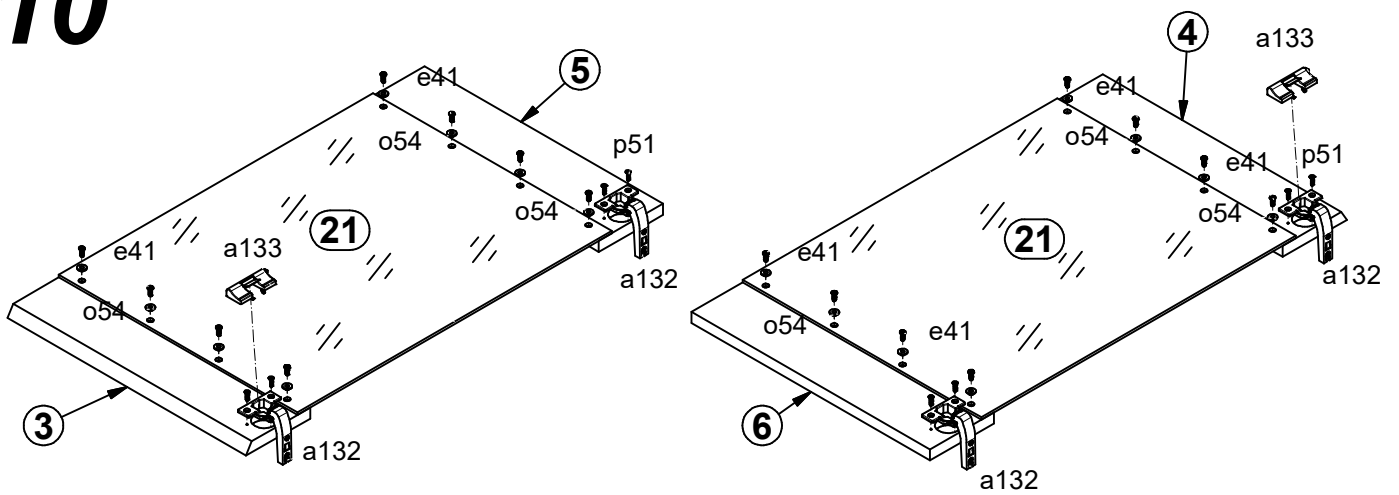

11

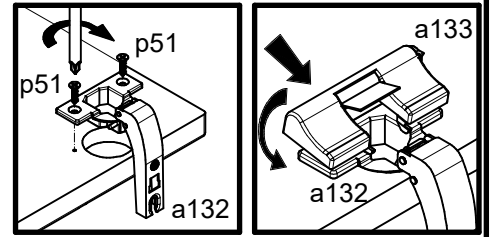
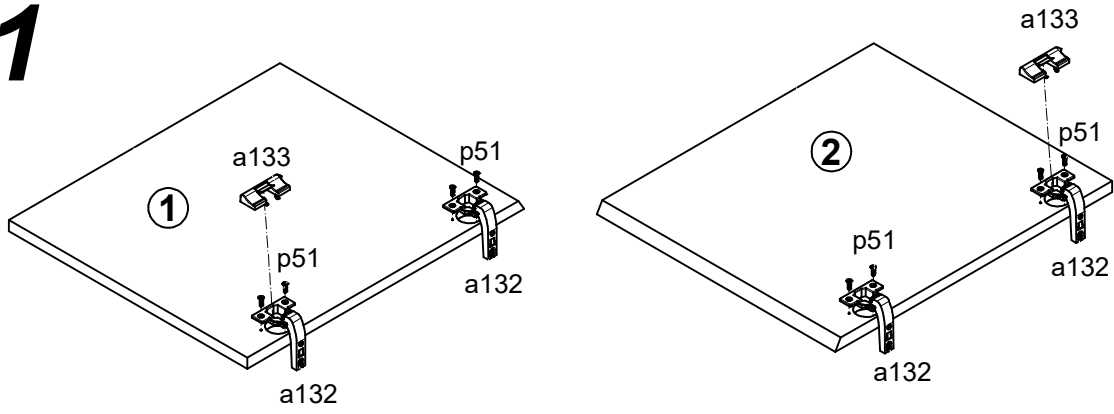

12

