

Model: *Roco*
Modell:

Typ: 01
Type:

Strona: 1/3
Blatt Nr:

PL
D
GB

INSTRUKCJA MONTAŻOWA MONTAGEANLEITUNG ASSEMBLY INSTRUCTIONS

Do montażu potrzebne są:
Für die Montage dieser Type benötigen Sie:

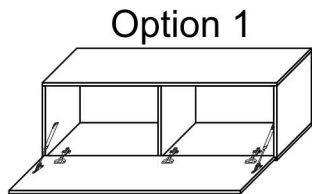
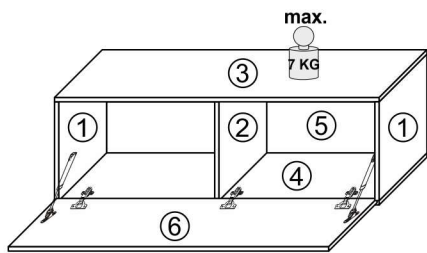

Option 2

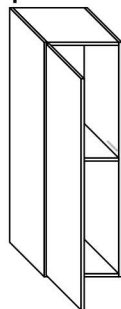

Option 3

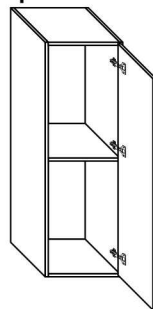

D Sehr geehrter Kunde, sollte ein Teil fehlen oder beschädigt sein, kreuzen Sie bitte dieses deutlich auf der Montageanleitung an und schicken Sie zu uns ab.
GB Dear customer, should there be any place missing or damaged, kindly mark this place clearly on the attached assembly instructions and return it to us.

PL Szanowny Kliencie, gdyby brakowało jakiegokolwiek części lub byłaby uszkodzona proszę to oznaczyć krzyżykiem na instrukcji montażowej i przesłać instrukcję razem z reklamacją.

Uwagi pielęgnacyjne!
Proszę wycierać ściereczką do kurzu lub lekko wilgotną ściereczką. Nie stosować ŻADNYCH środków rysujących powierzchnie.

Pflegehinweis!
Bitte nur mit einem Staubtuch oder einem feuchtem Lappen reinigen. KEINE scheuernde Putzmittel verwenden!

Beutel 1

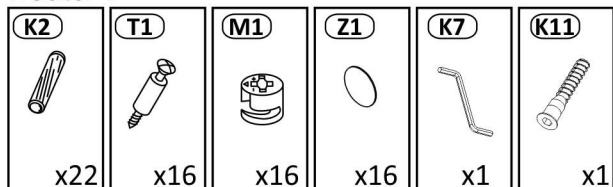

Beutel 2

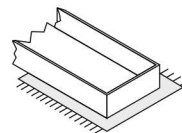
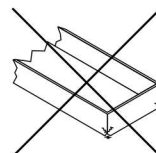
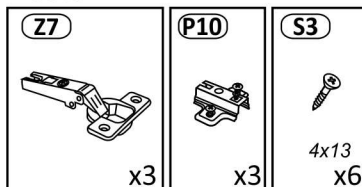

Proszę montować mebel na kartonie!
Bitte das Möbel auf der Verpackung montieren.

Beutel 3



Beutel 4

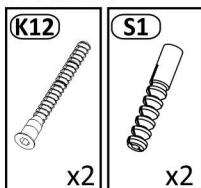

Beutel 5

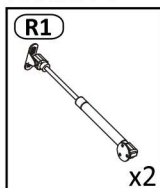

1

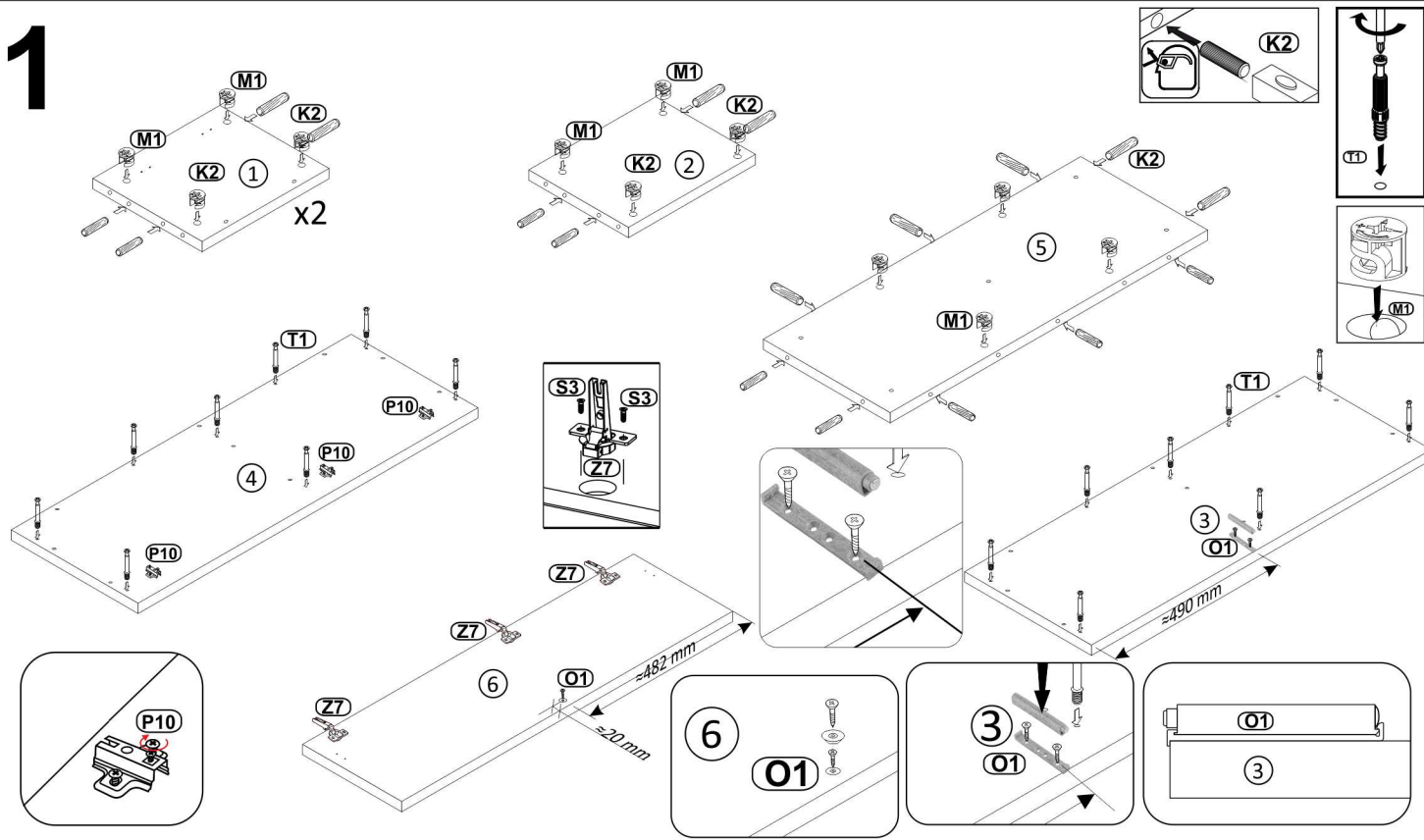

1

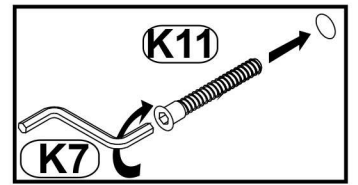
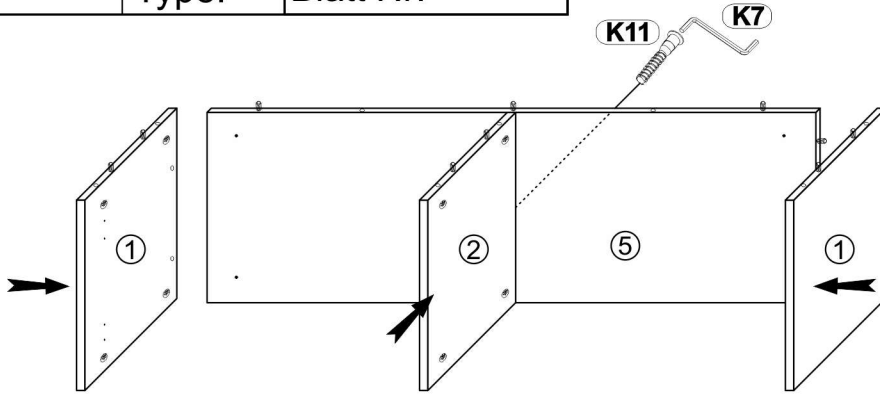

2

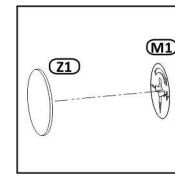
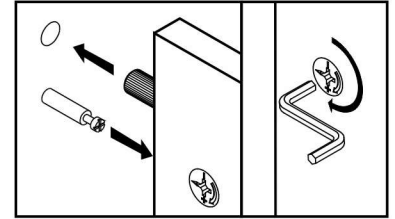
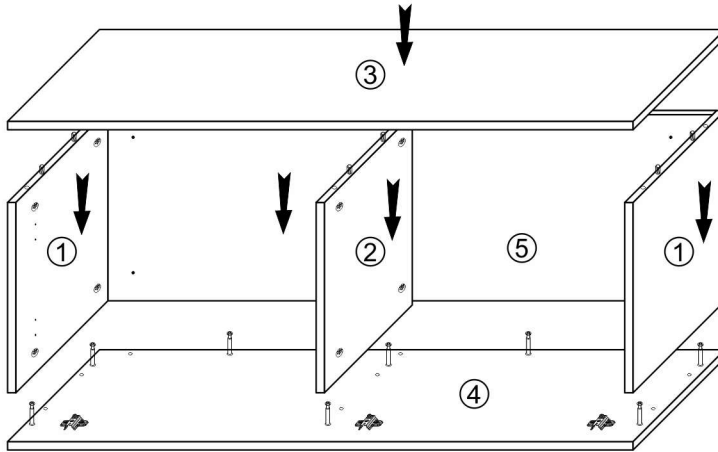

3

Option 1

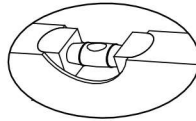

Option 2 & 3

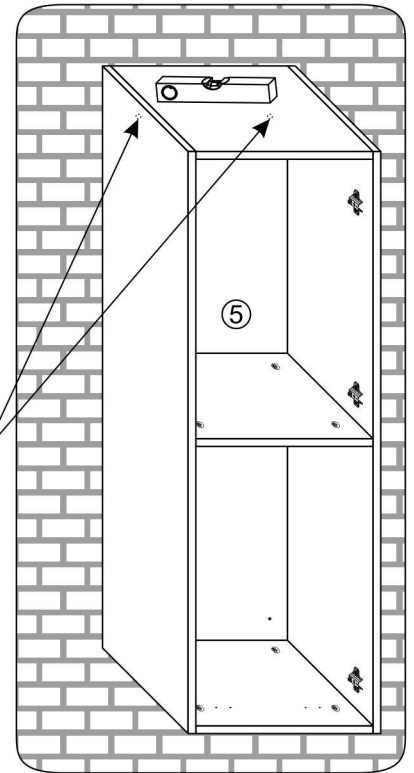
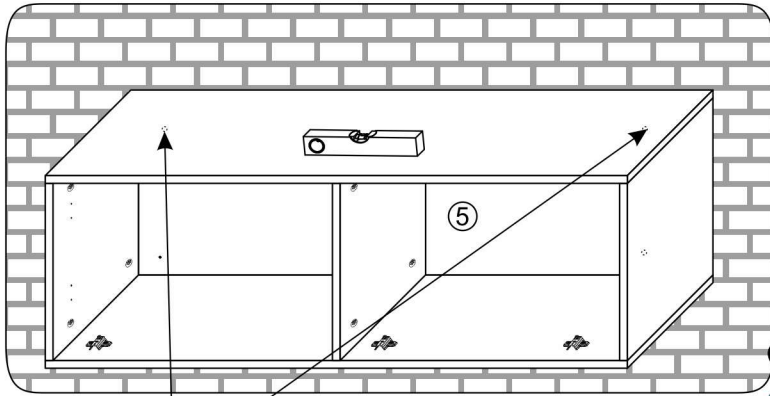

Ø 8mm

Ø 8mm

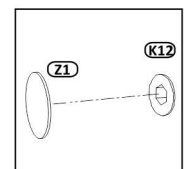
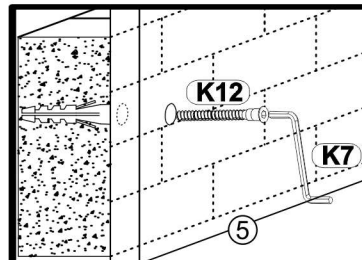
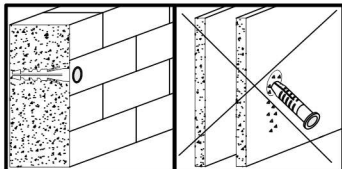
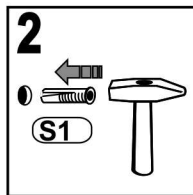
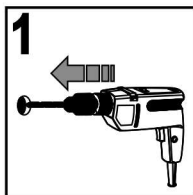

4 Option 1

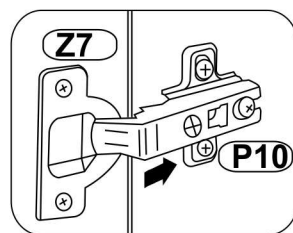
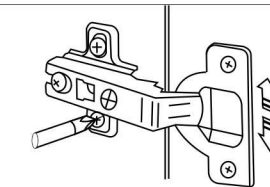
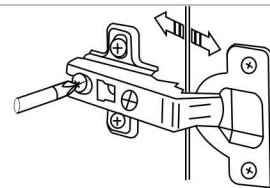
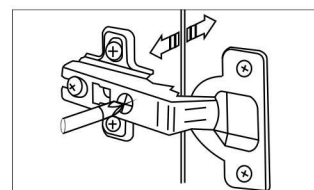
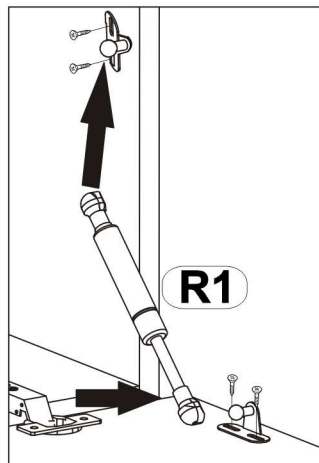
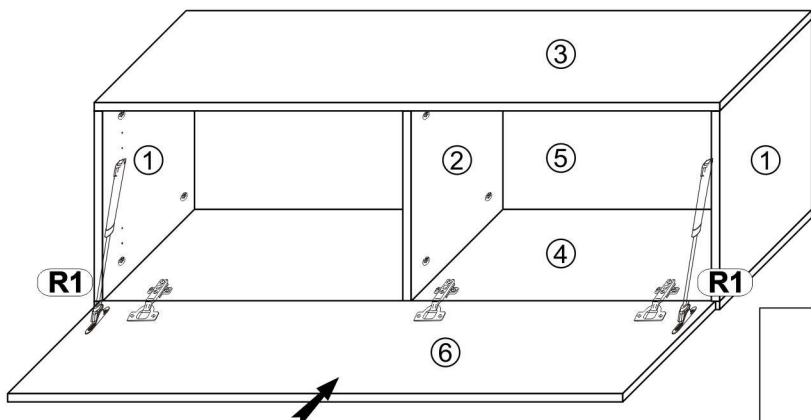

5 Option 2

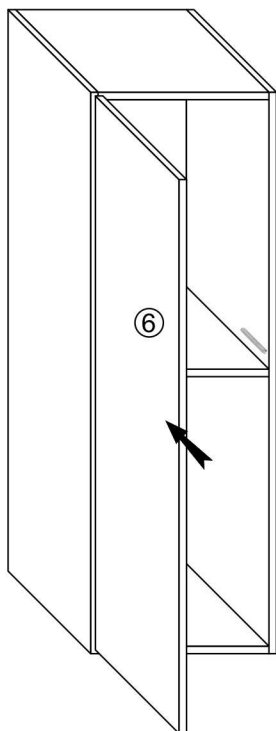

Option 3

