

# NANO

# 6

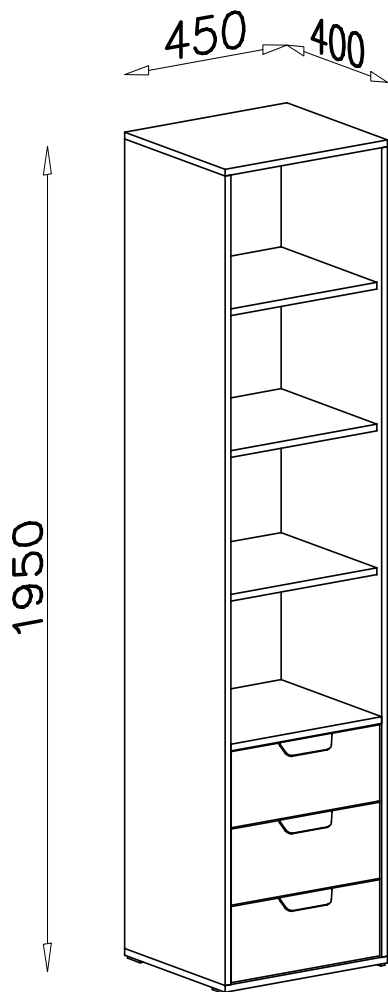

P3

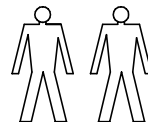
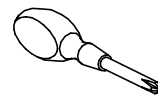
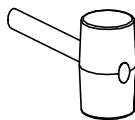
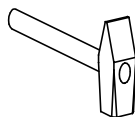
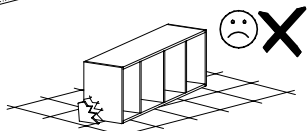
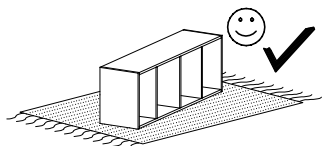
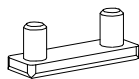

x4

G4



4x16

x18

E36



x3

W1



x2

H7

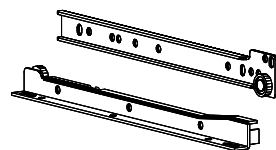

350mm

x3

A1

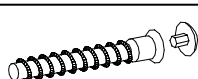

ø7x50

x6

B7



ø8x30

x36

G2



3x20

x50

G13



4x22

x6

W2

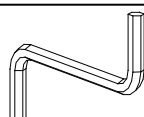

x1

F1

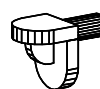

x12

G10



6x13

x12

1

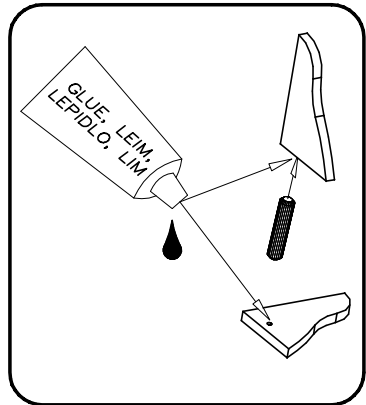
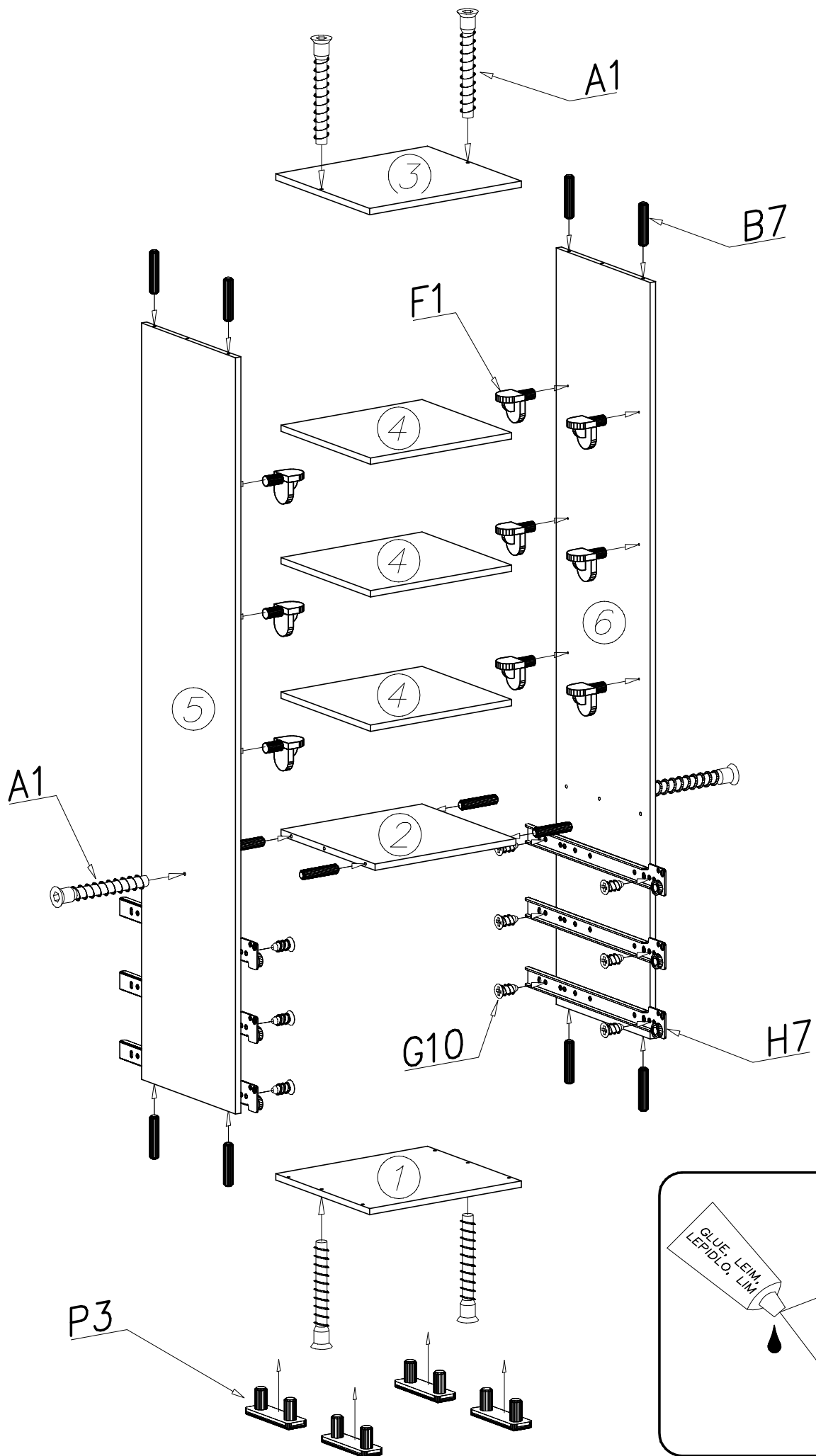

II

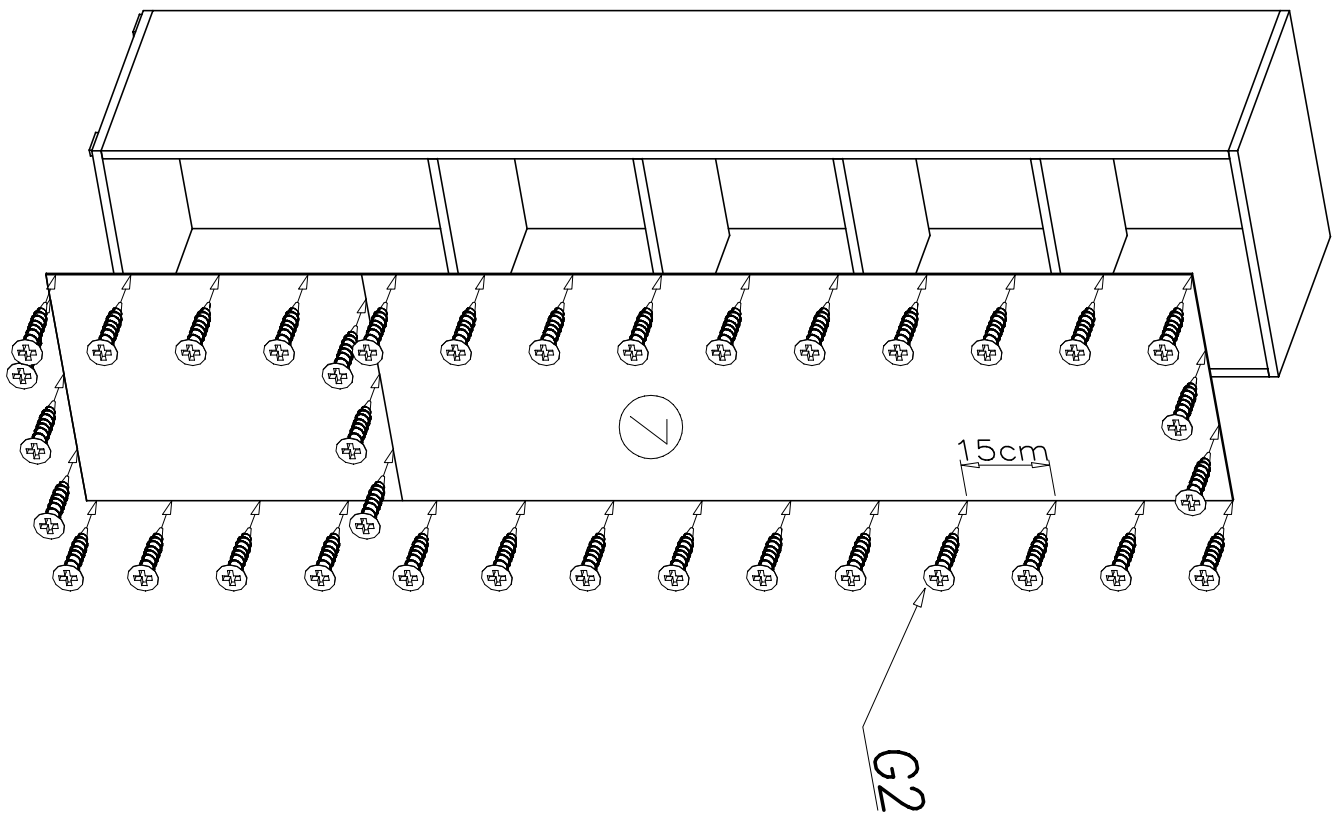

III

