

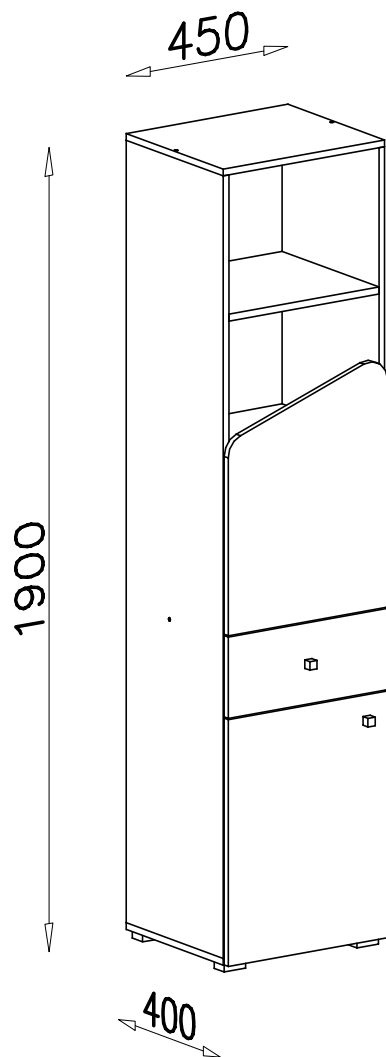

# DELTA DL5

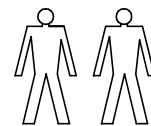
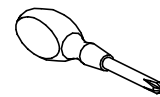
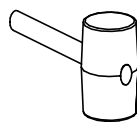
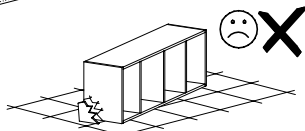
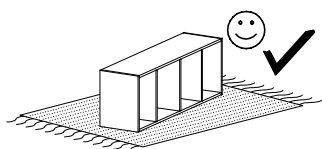
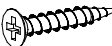

**G12**  
  
 3,5x25 x8

**E38**  
  
 x2

**W1**  
  
 GLUE, LEIM, LEPIDLO, LIM  
 x1

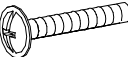
**N13**  
  
 M4x22 x2

**D3**  
  
 PZ35PR x4

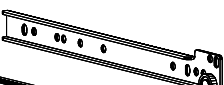
**H7**  
  
 350mm x1

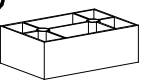
**P15**  
  
 x4

**G4**  
  
 4x16 x14

**G2**  
  
 3x20 x40

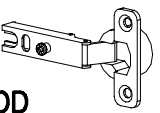
**C3**  
  
 Z350D x4

**350mm**  
 x1

**A1**  
  
 ø7x50 x6

**B7**  
  
 ø8x30 x20

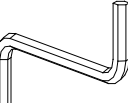
**W2**  
  
 x1

**F1**  
  
 x12

**G10**  
  
 6x13 x4

1

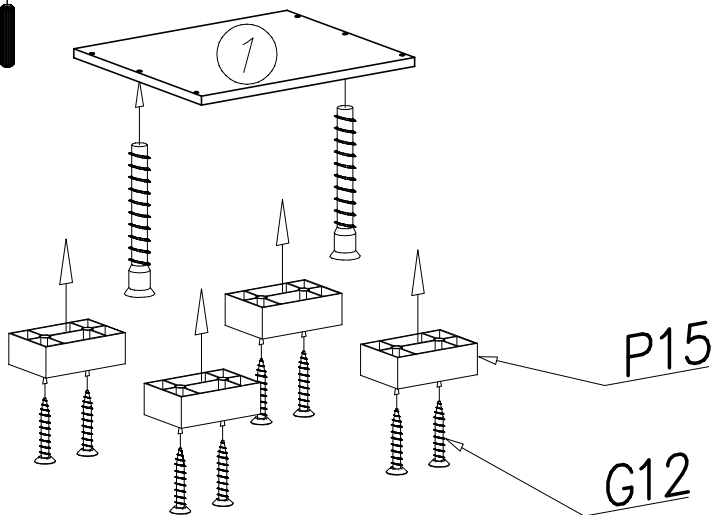
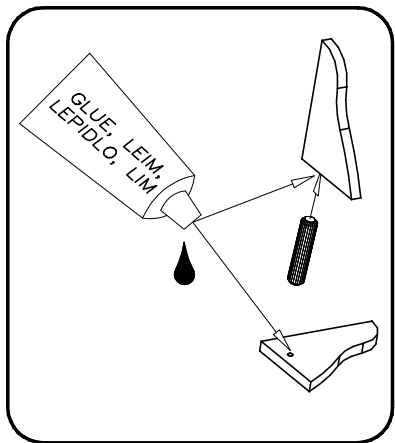
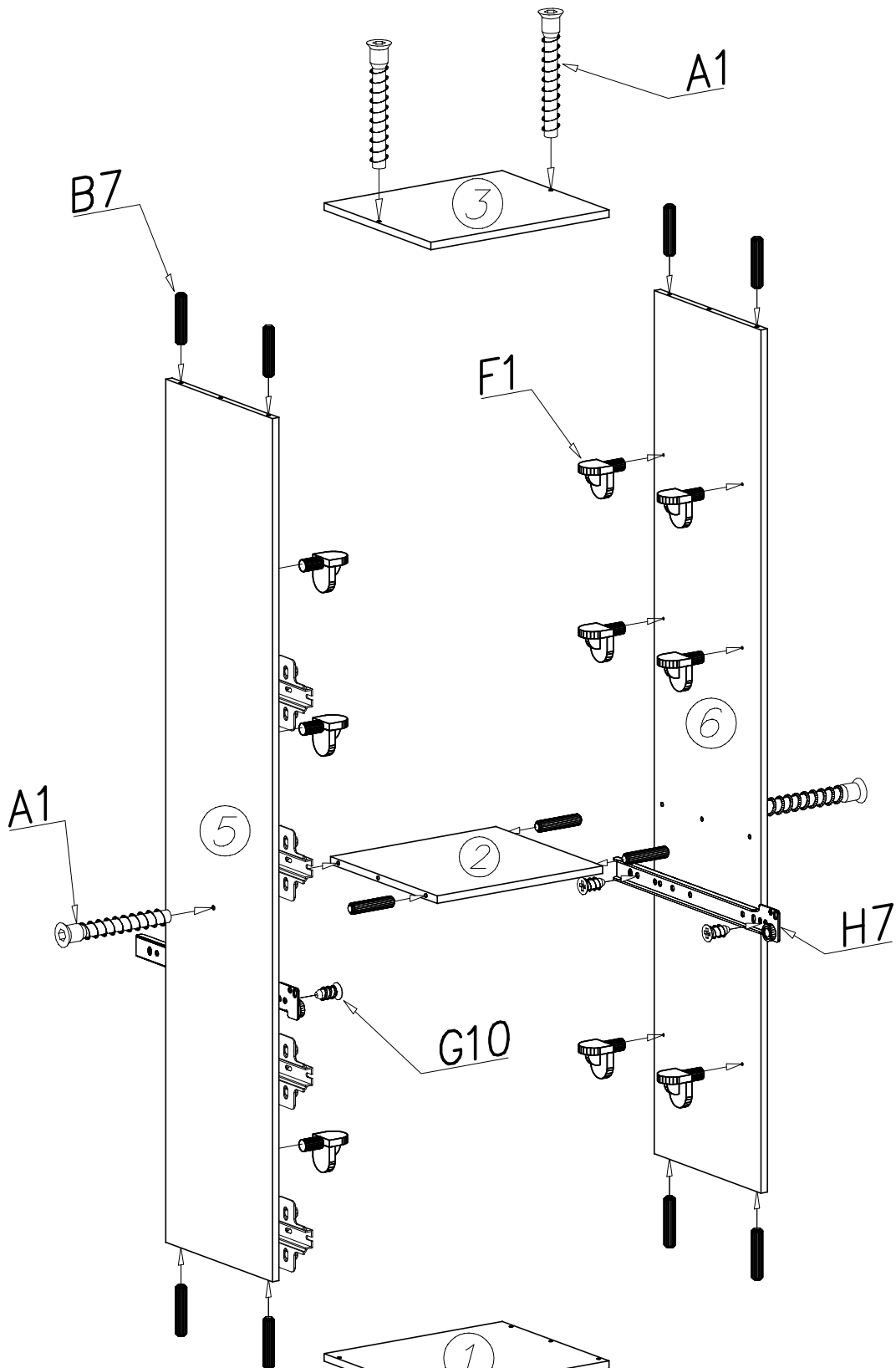

II

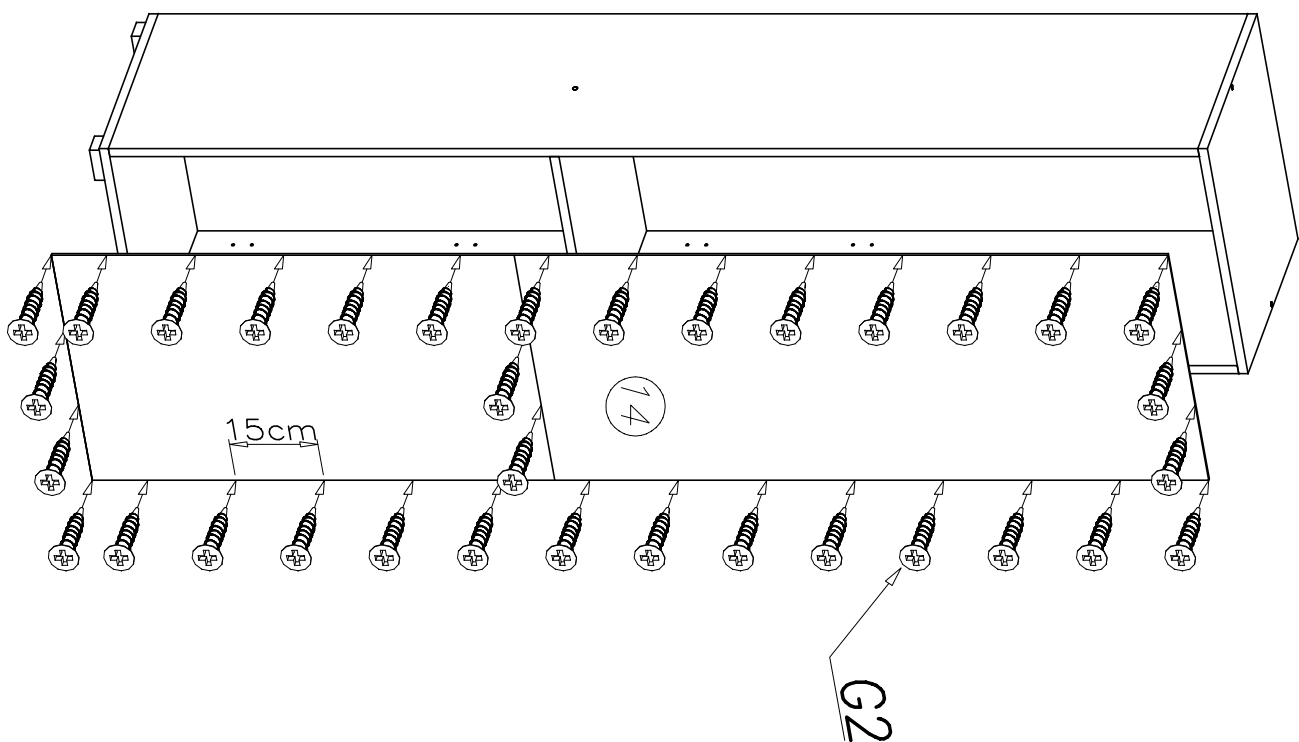

III

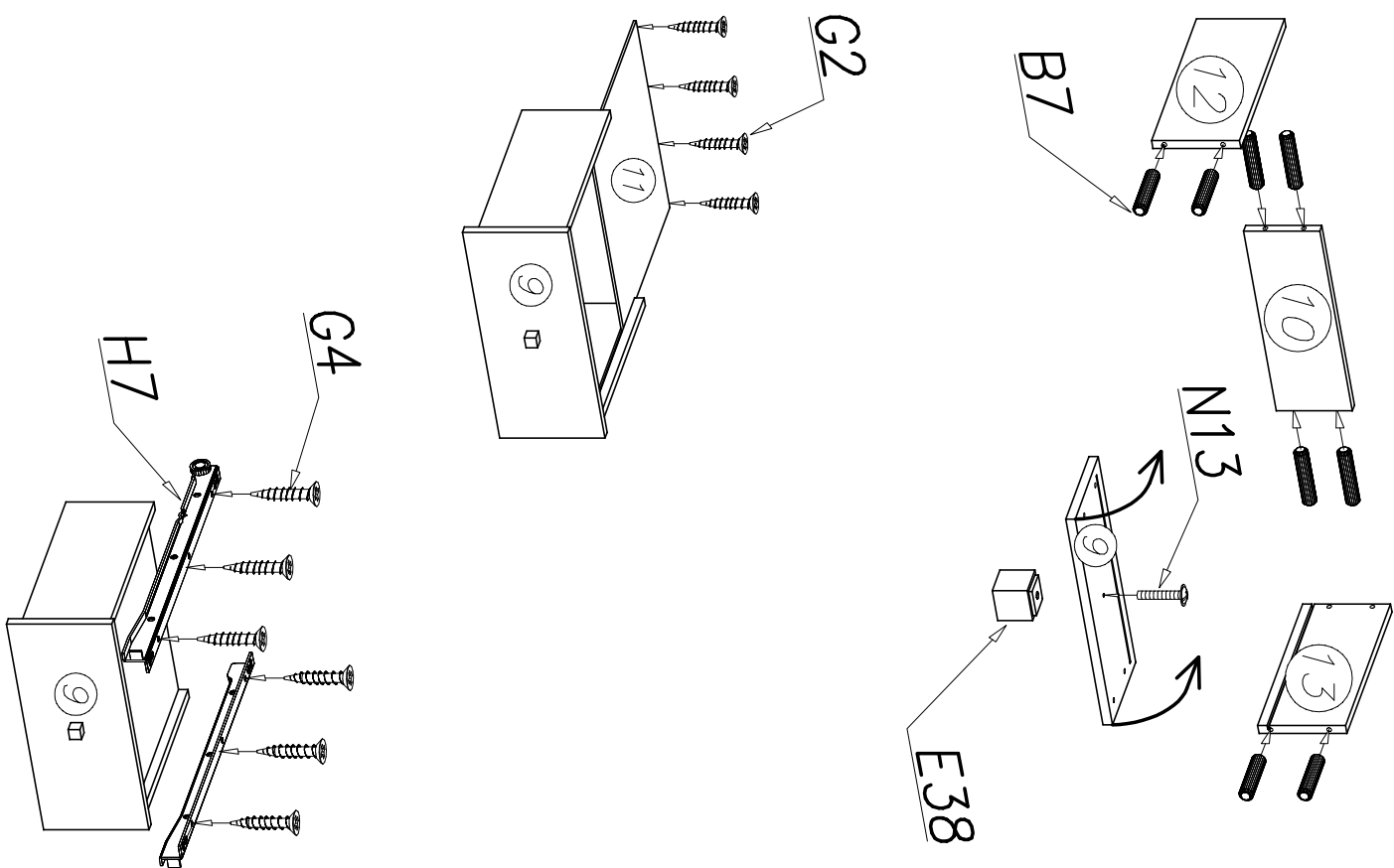

IV

