

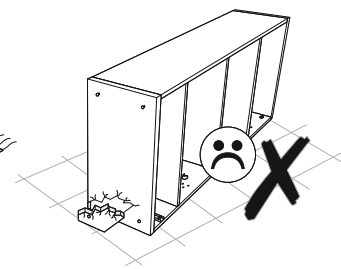

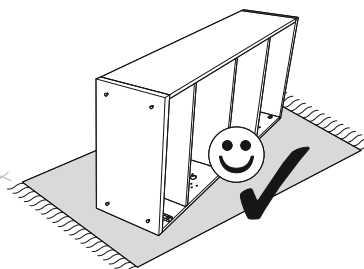

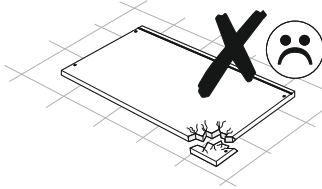

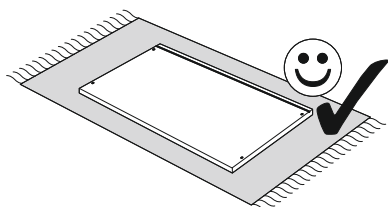
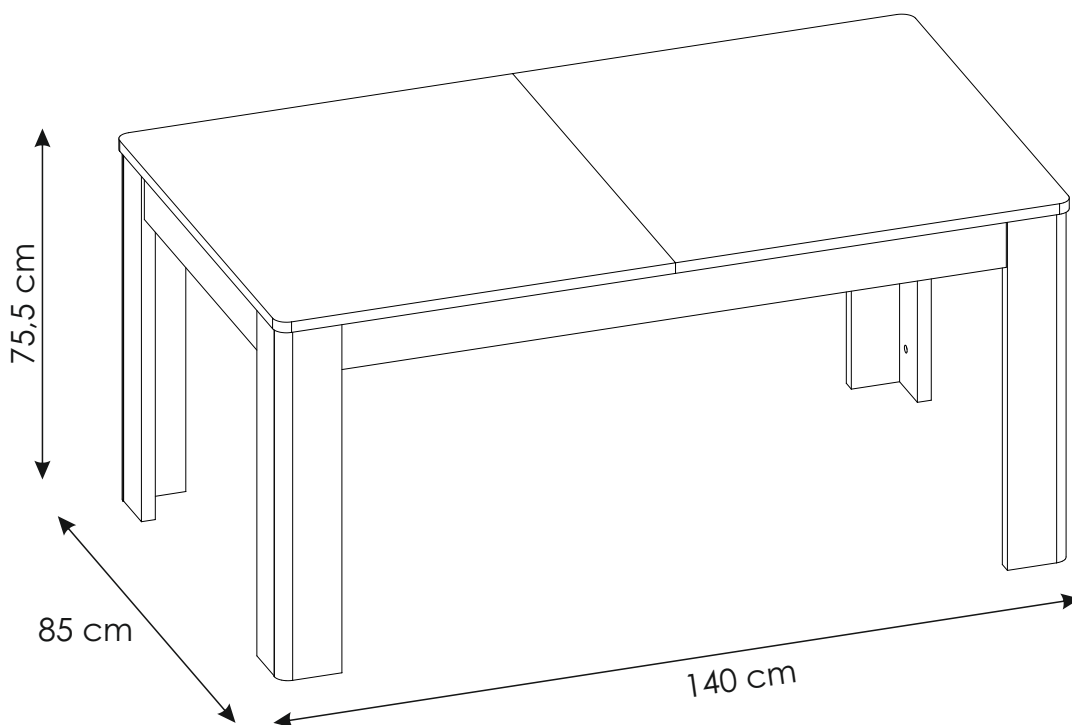
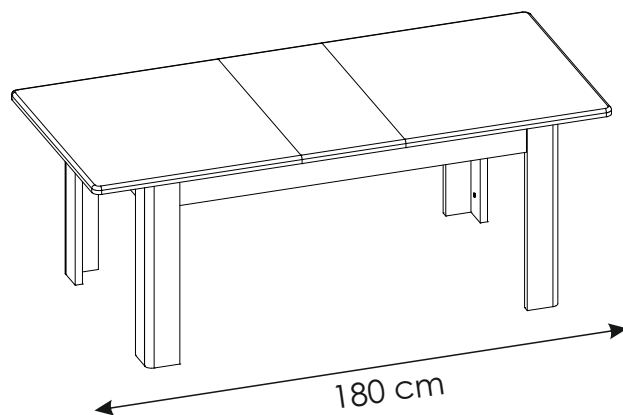
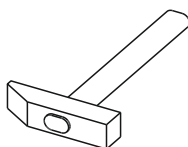
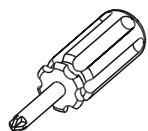
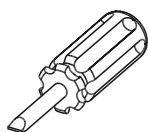
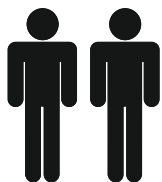
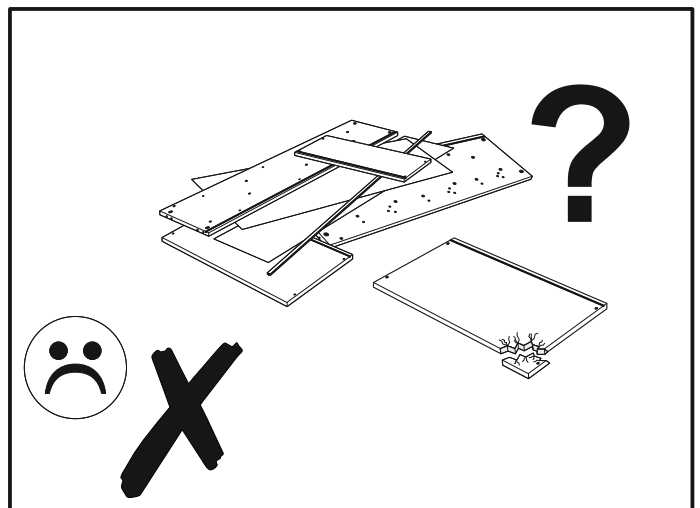
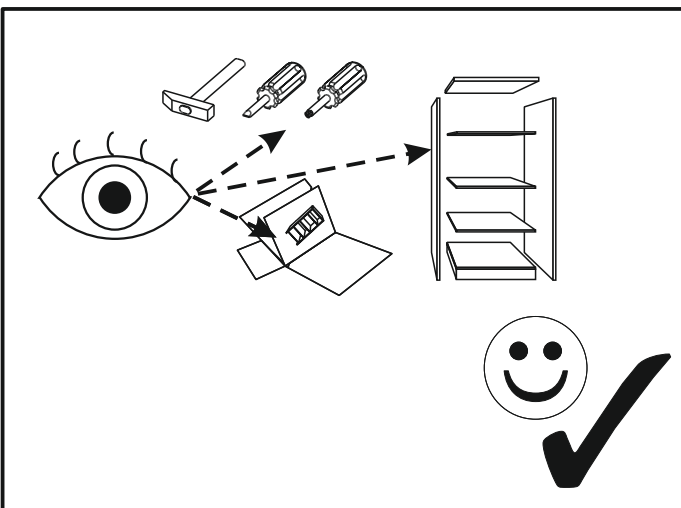
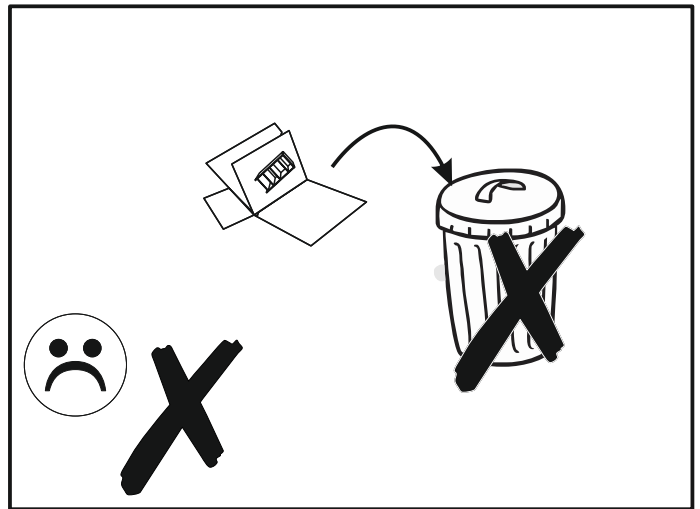
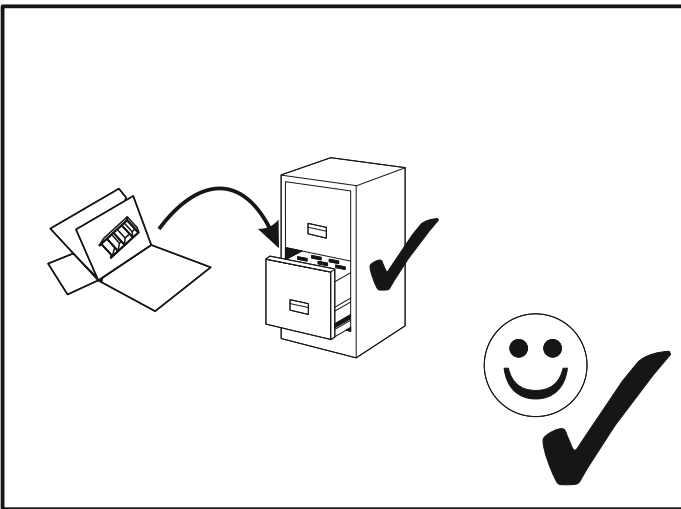
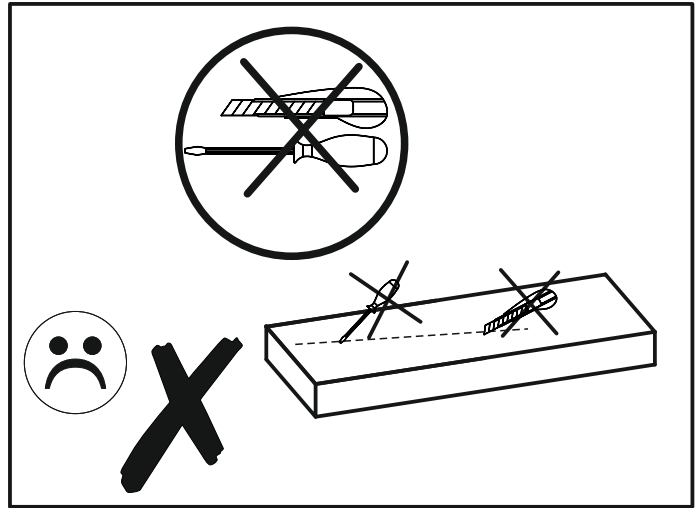
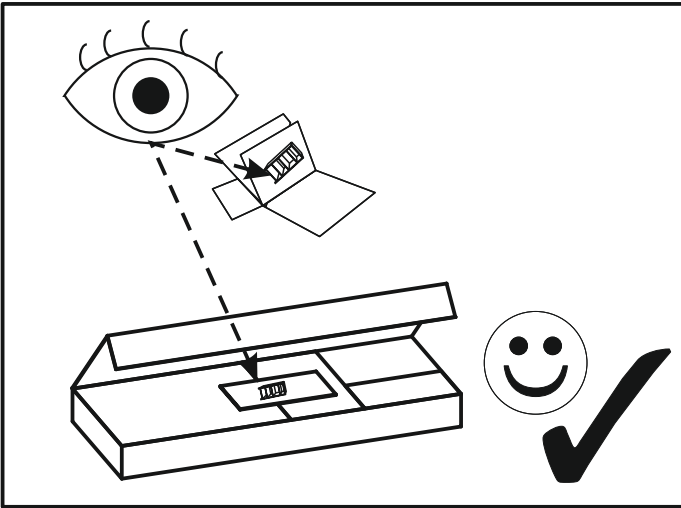
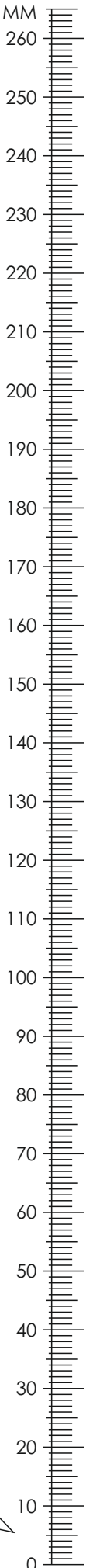

# CNAT05



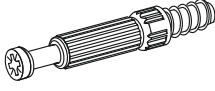
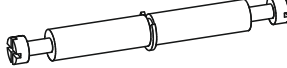

# CNAT05

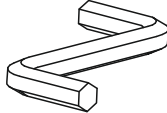
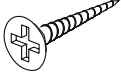
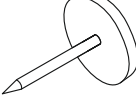

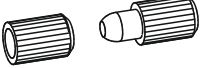
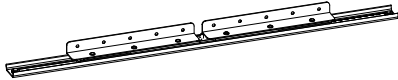
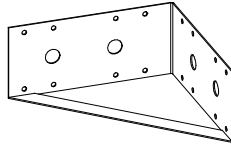
<b>A1</b> 8 x 35 mm x20 	<b>A2</b> 8 x 45 mm x16 	<b>E0</b>  x32
<b>E1</b> 15 x 12,5 mm x32 	<b>F1</b> 6 x 34 mm x16 	<b>F3</b> 7 x 58 mm x8 
<b>I2</b> 4 x 16 mm x64 	<b>I8</b> 4 x 20 mm x20 	<b>M</b>  x1
<b>N2</b> 3,5 X 16 mm x20 	<b>O2</b>  x8	<b>O2A</b> ø20 x4 
<b>R8</b>  x8	<b>T0</b> L-700 x2 	<b>W</b>  x4

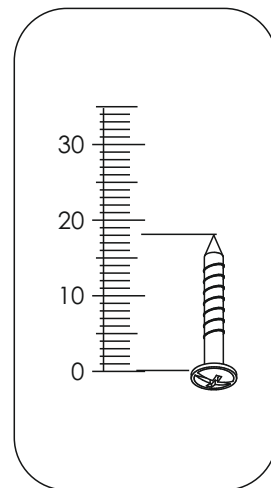

# CNAT05

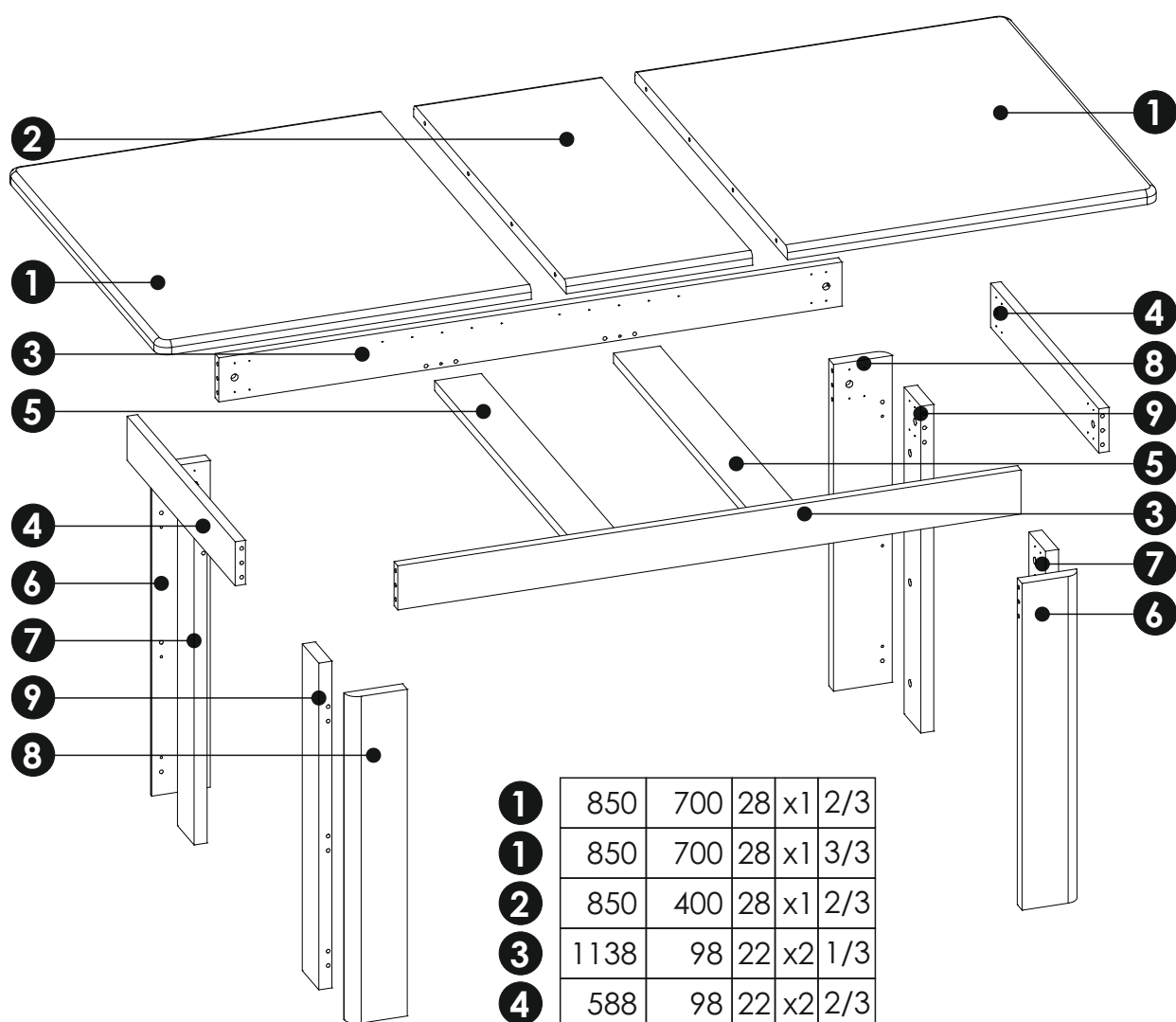

<b>1</b>	850	700	28	x1	2/3
<b>1</b>	850	700	28	x1	3/3
<b>2</b>	850	400	28	x1	2/3
<b>3</b>	1138	98	22	x2	1/3
<b>4</b>	588	98	22	x2	2/3
<b>5</b>	784	100	22	x2	1/3
<b>6</b>	721	126	28	x2	1/3
<b>7</b>	721	98	28	x2	1/3
<b>8</b>	721	126	28	x2	1/3
<b>9</b>	721	98	28	x2	1/3

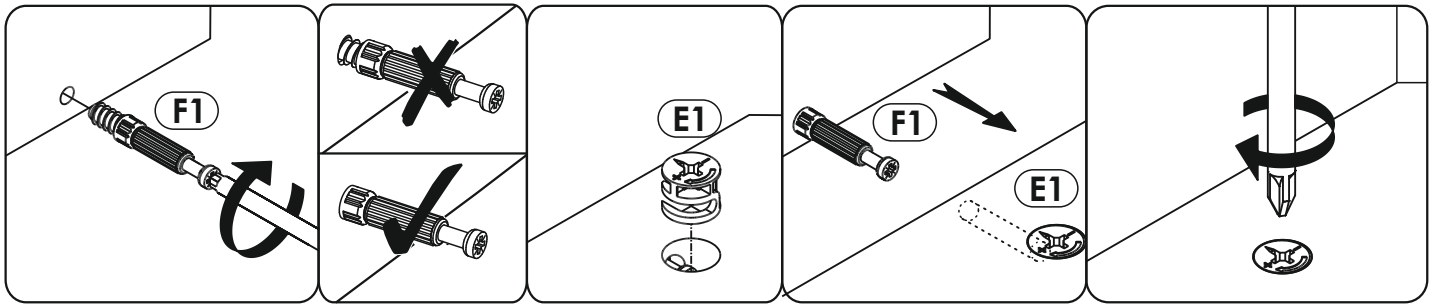

1▶

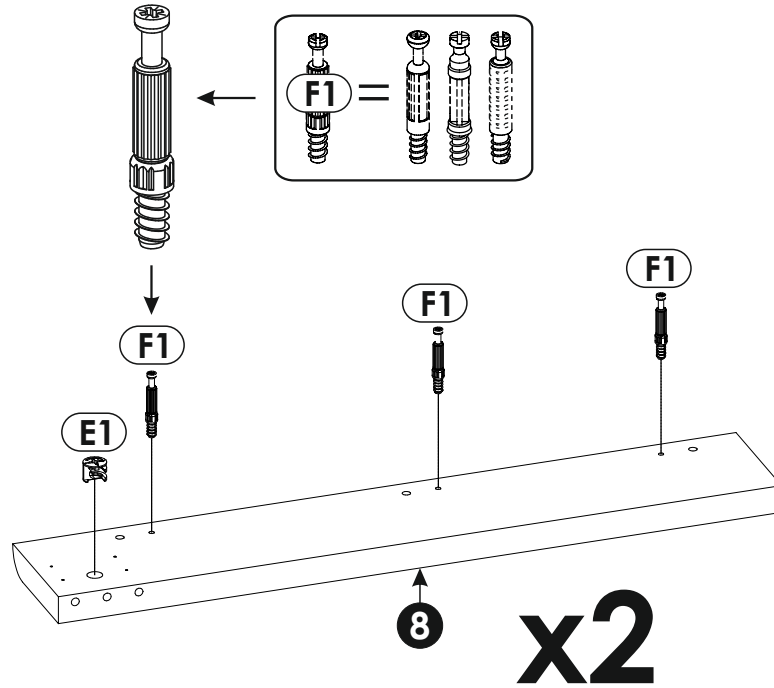

2▶

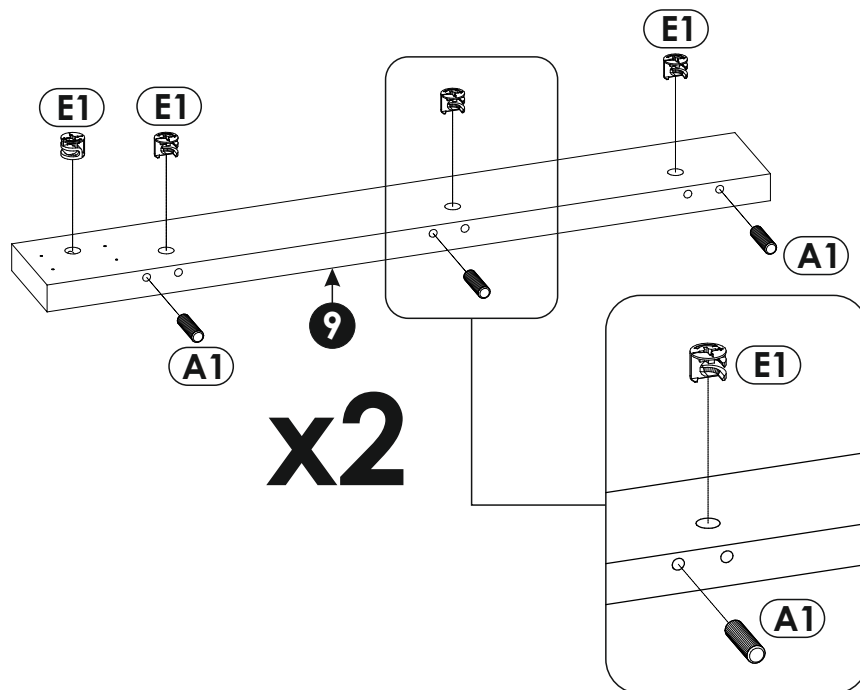

3▶

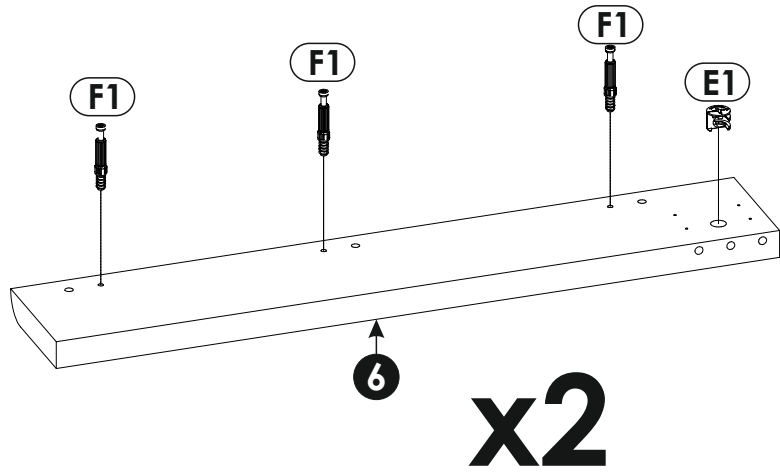

4▶

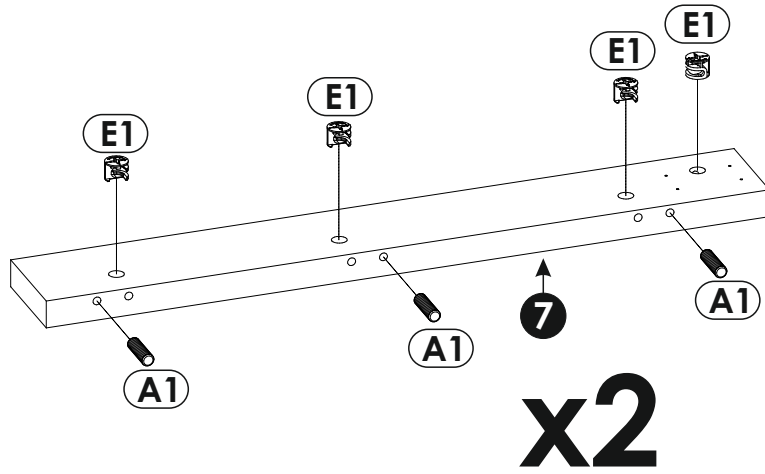

5 ▶

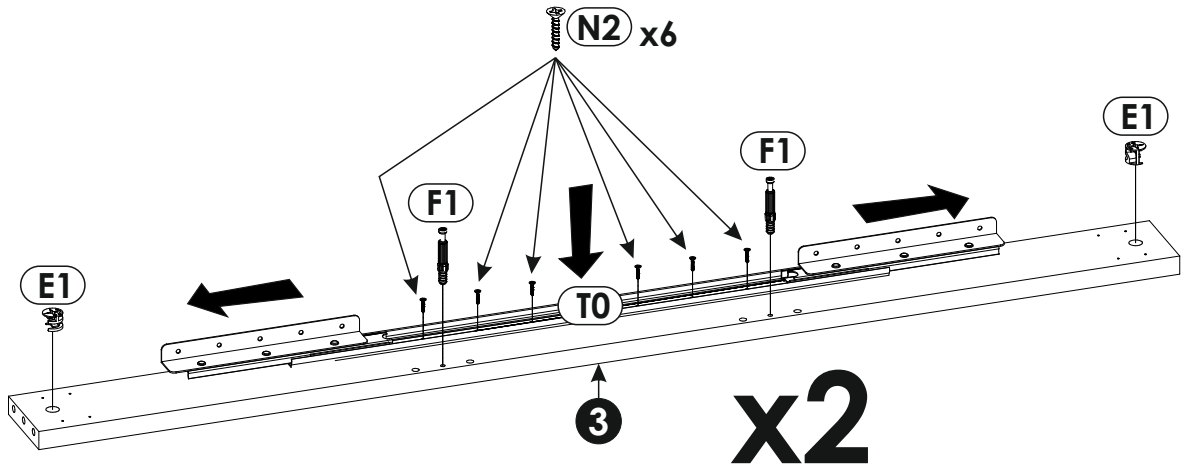
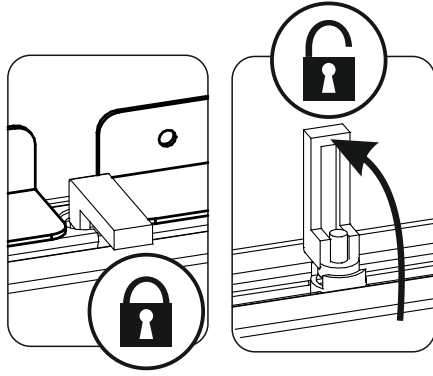

6 ▶

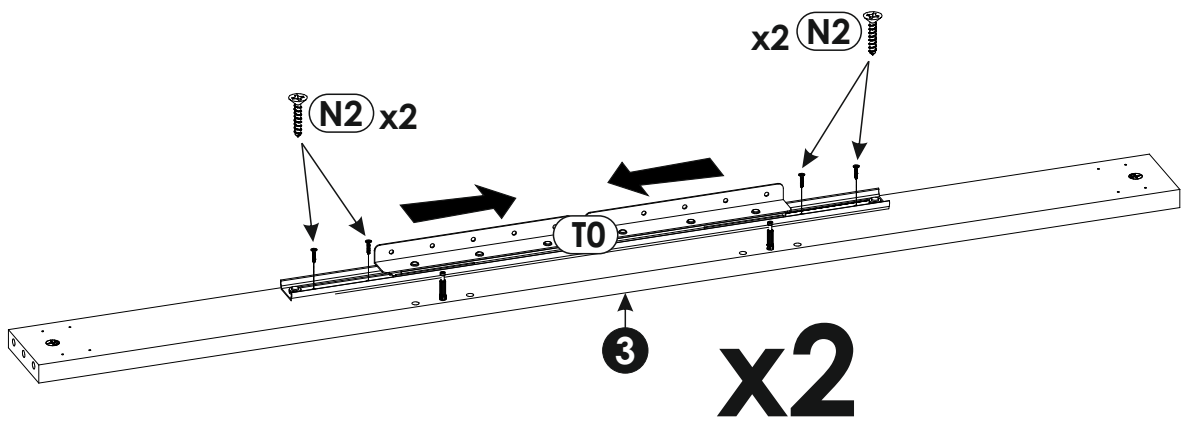

7 ▶

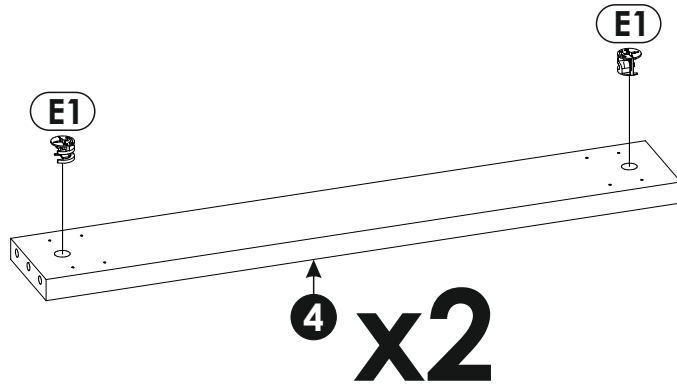

8 ▶

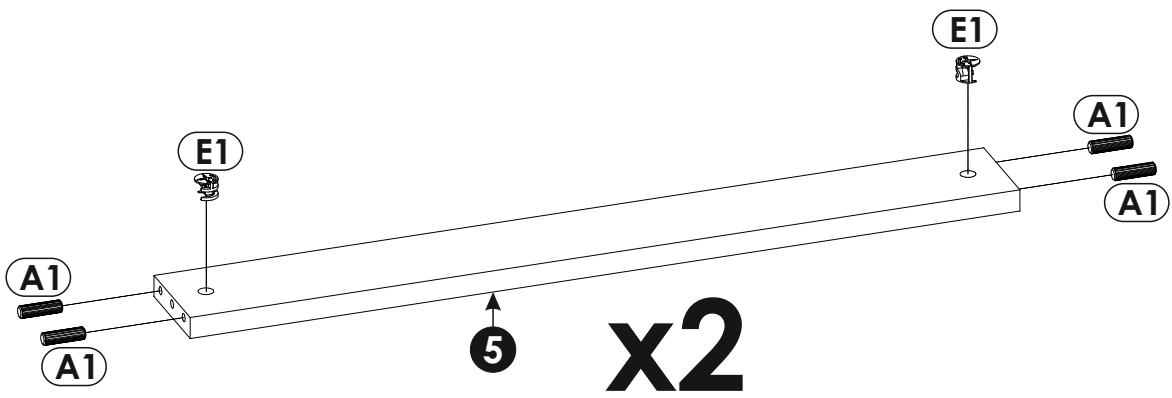



9 ▶

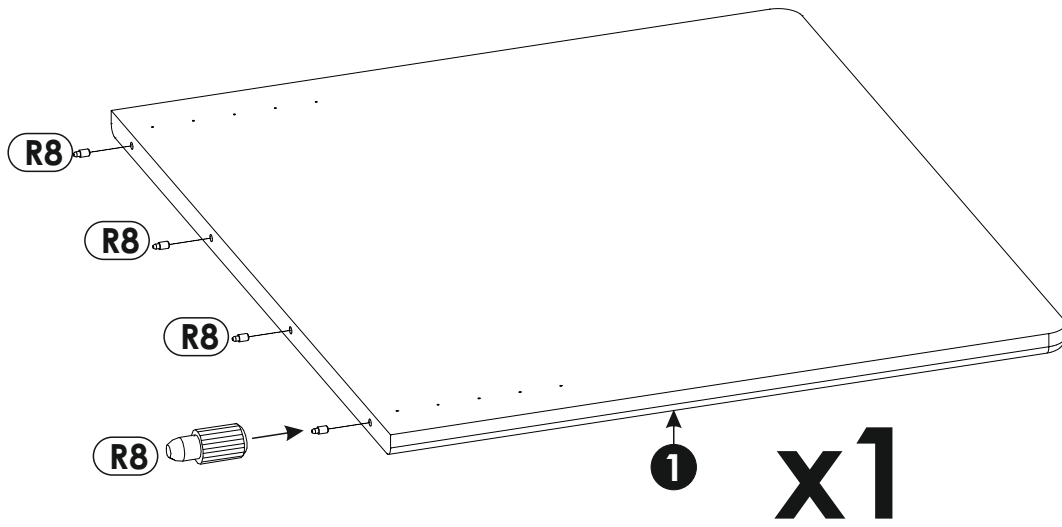

10 ▶

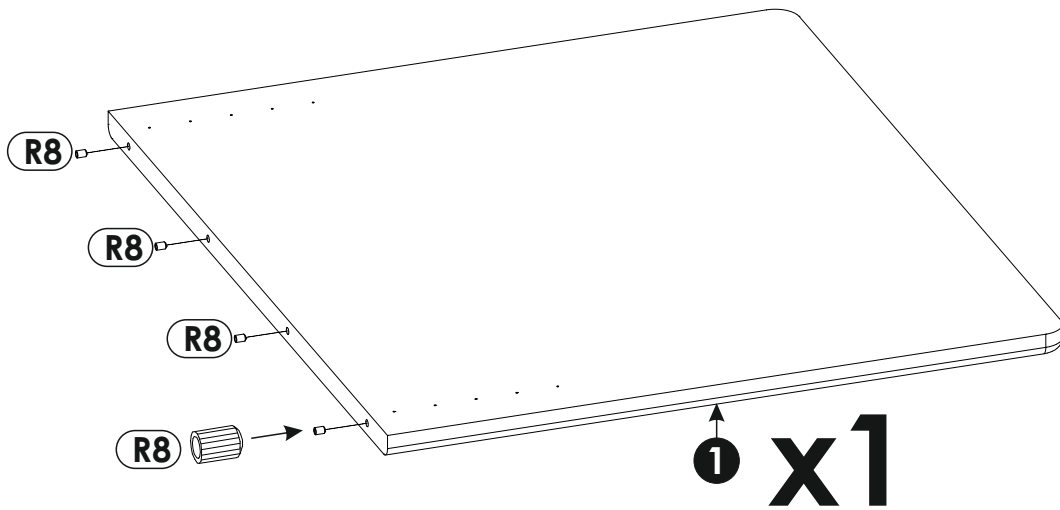

11 ▶

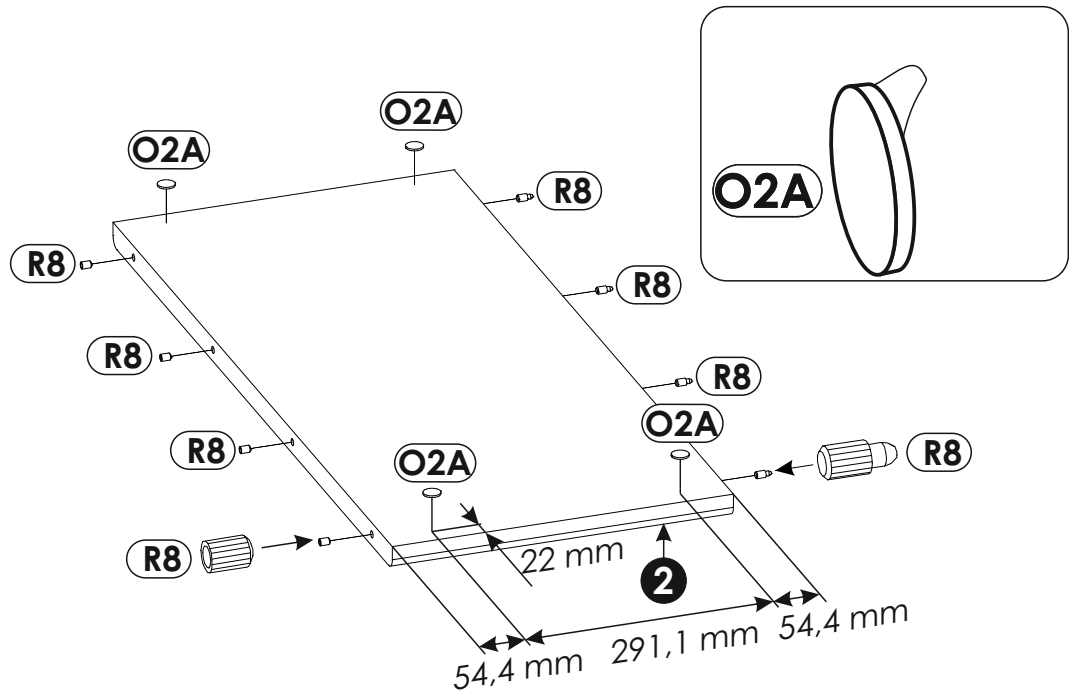

12 ▶

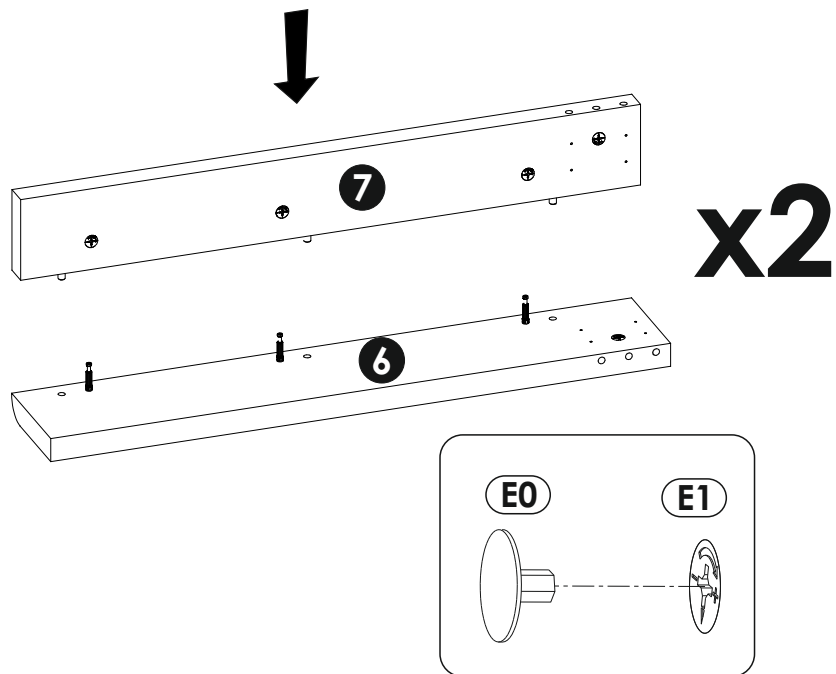

13▶

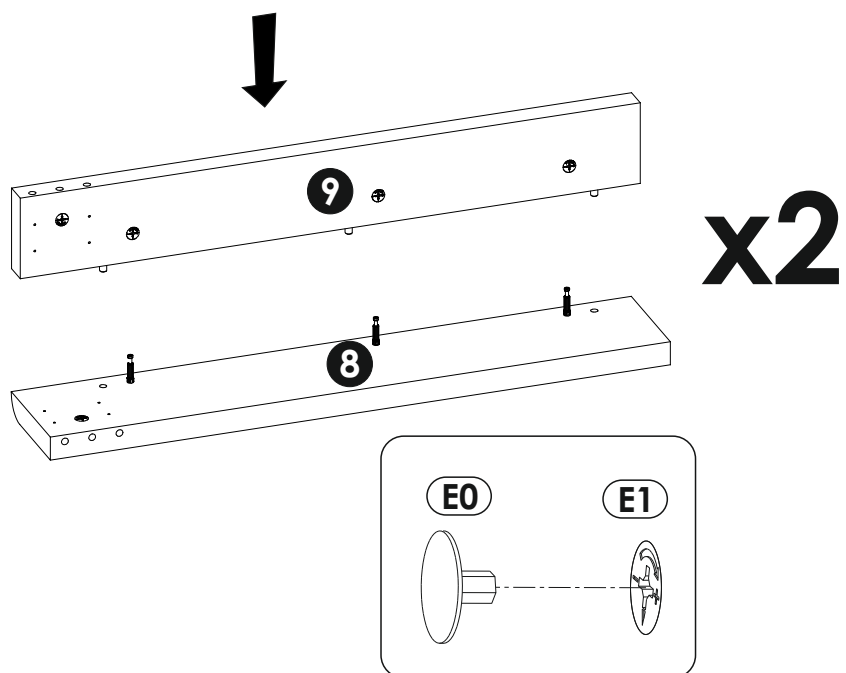

14▶

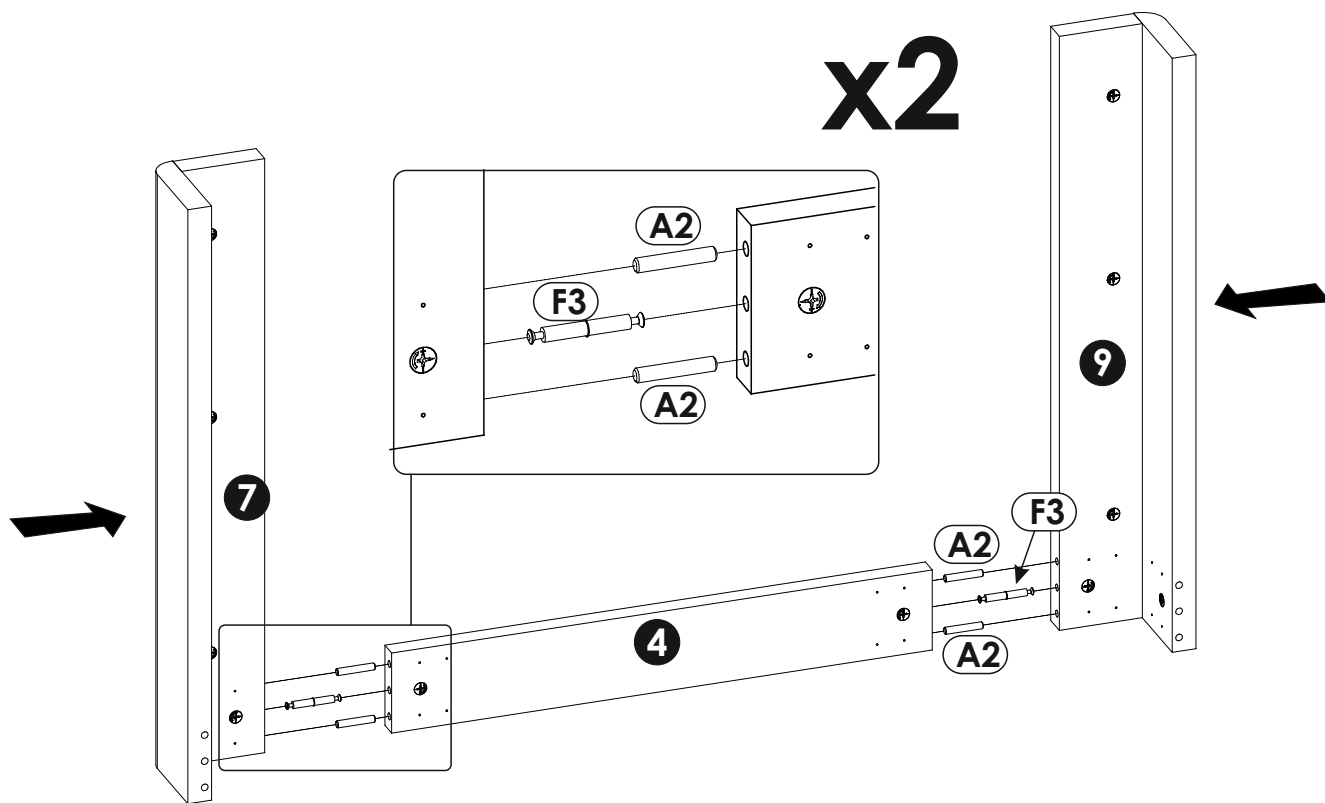

15▶

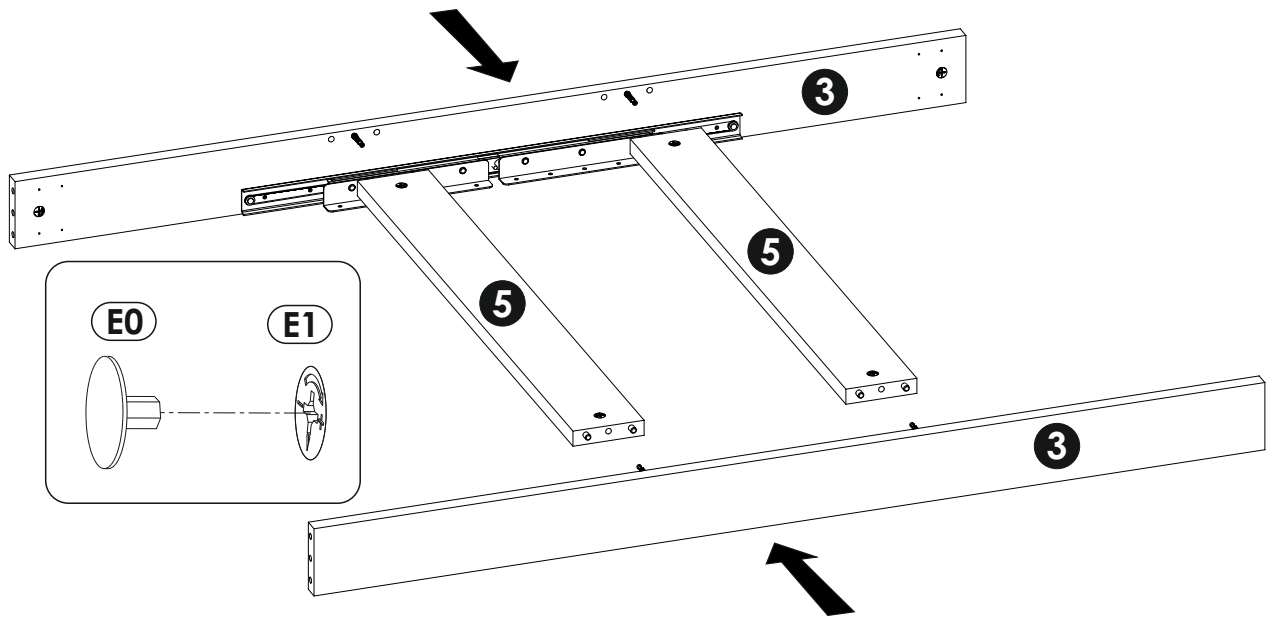

16▶

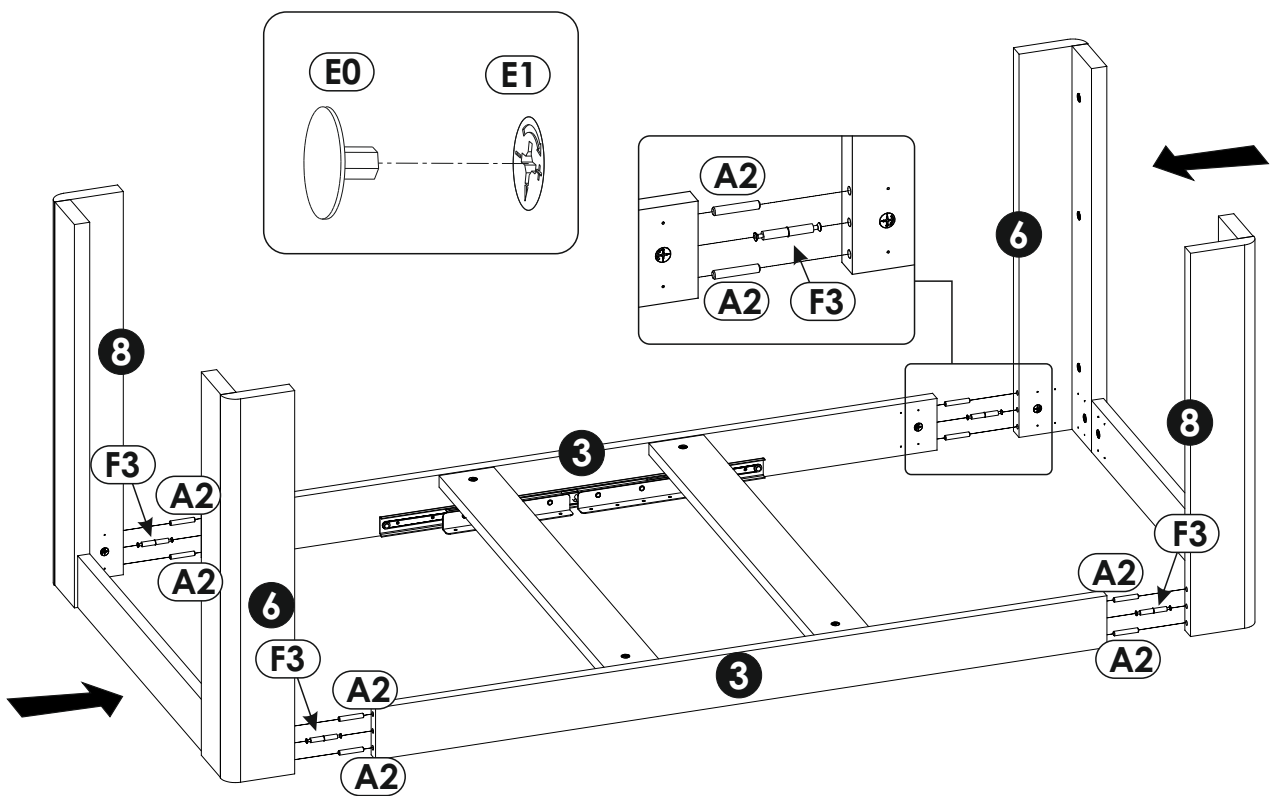

17▶

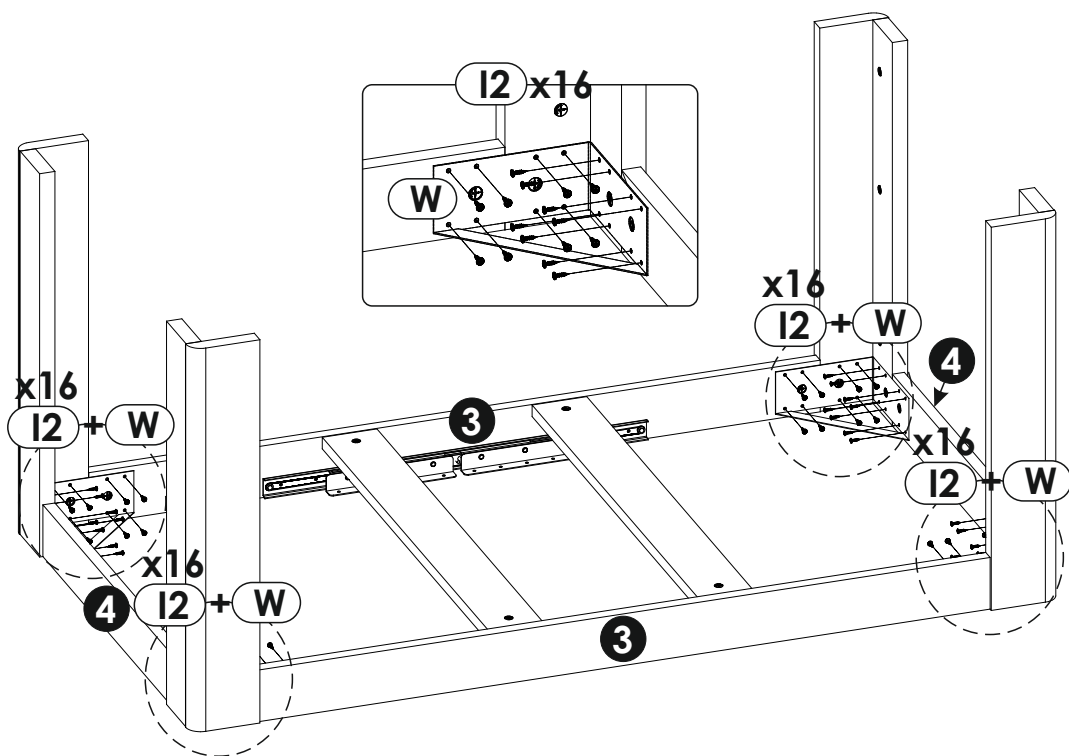

18▶

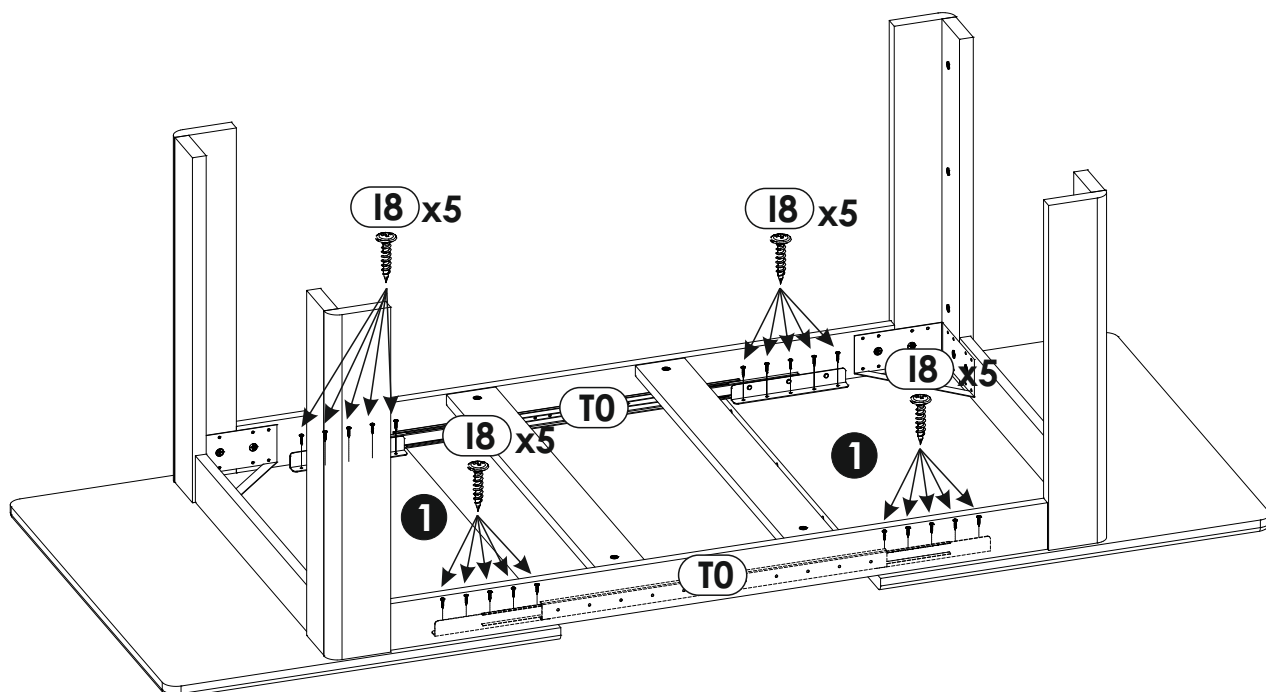

19▶

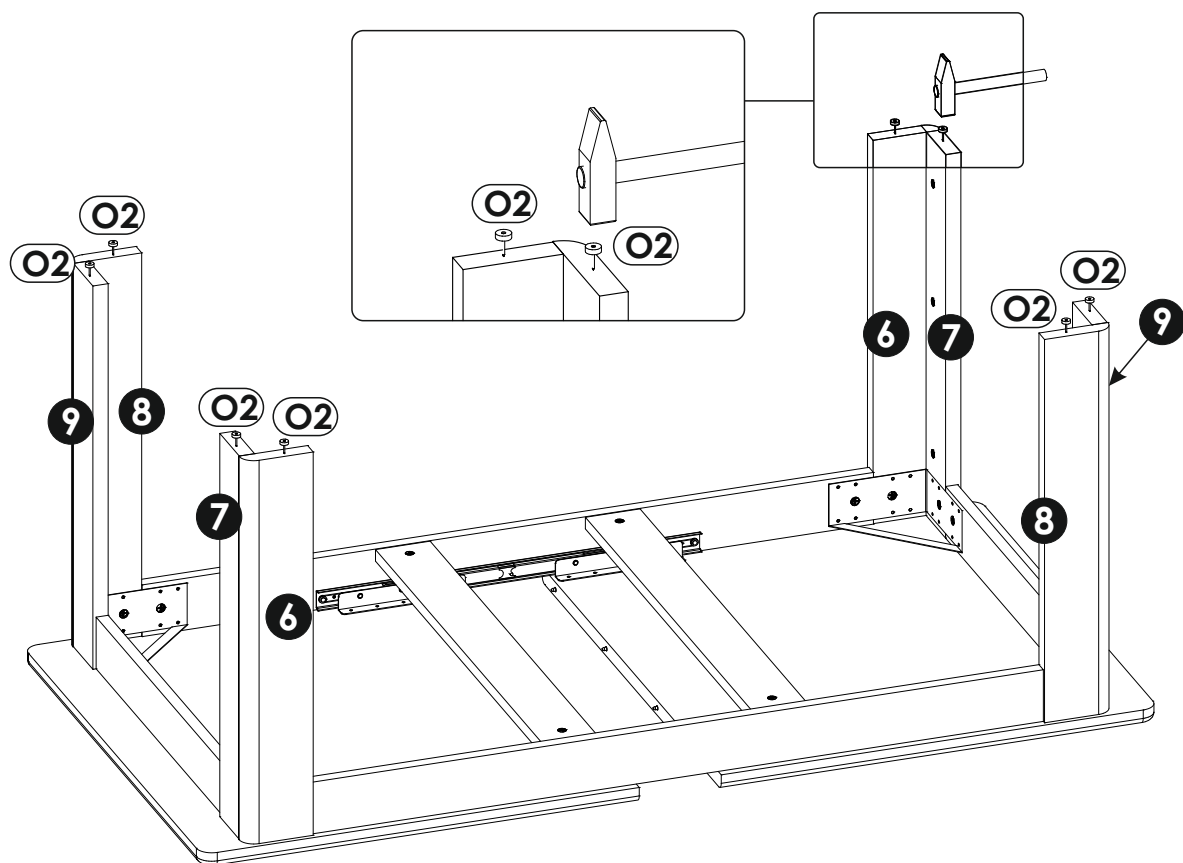

20▶

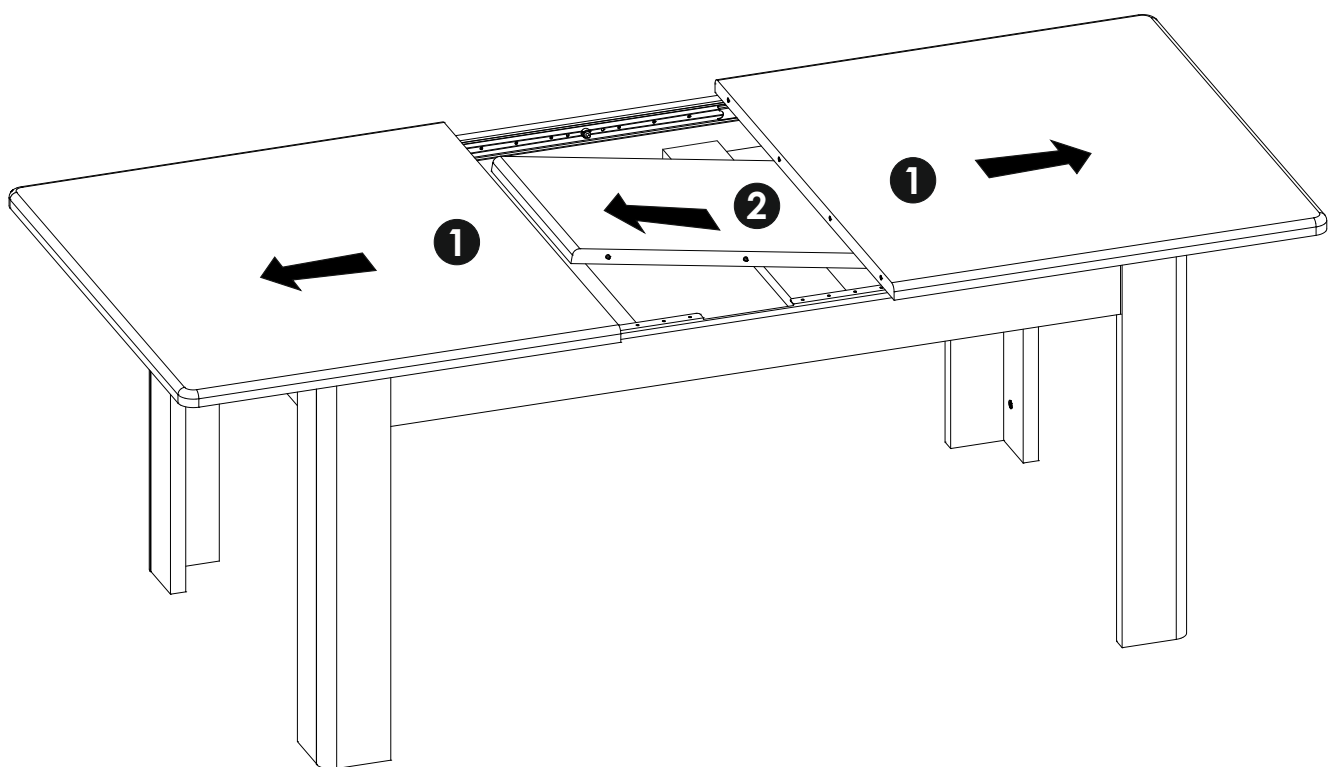

21 ▶

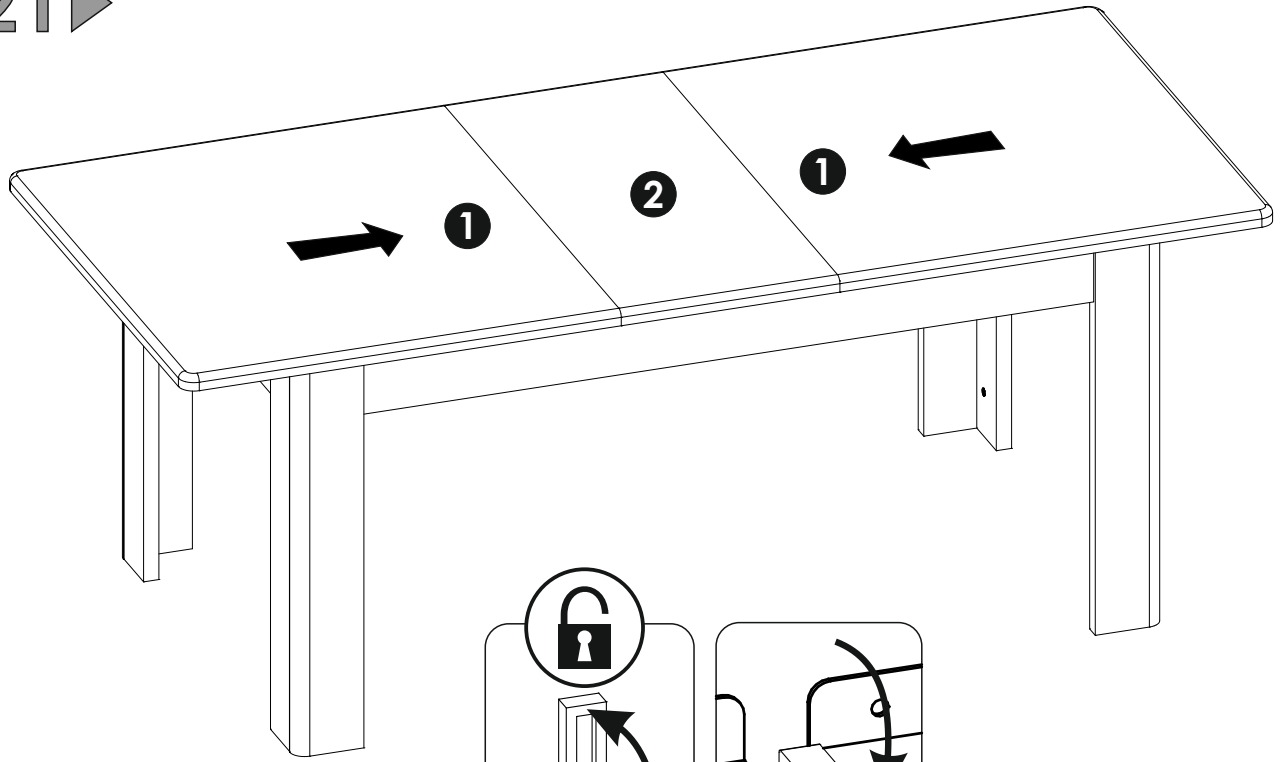

22 ▶

