

# CNAS02

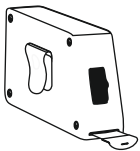

Ø8

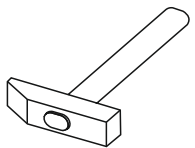

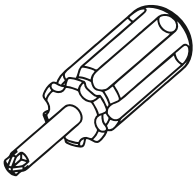
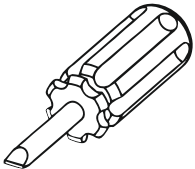
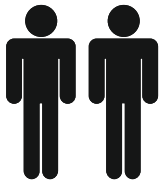
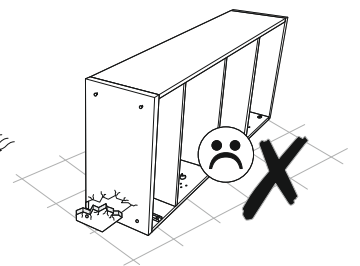
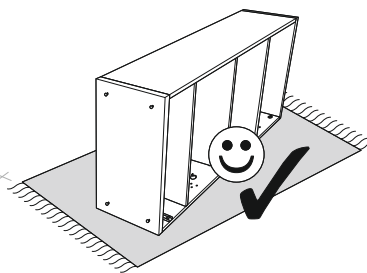
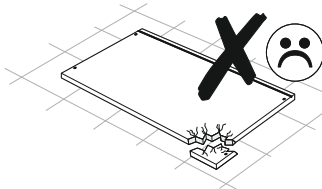
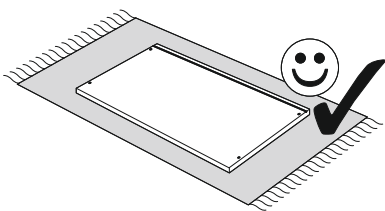
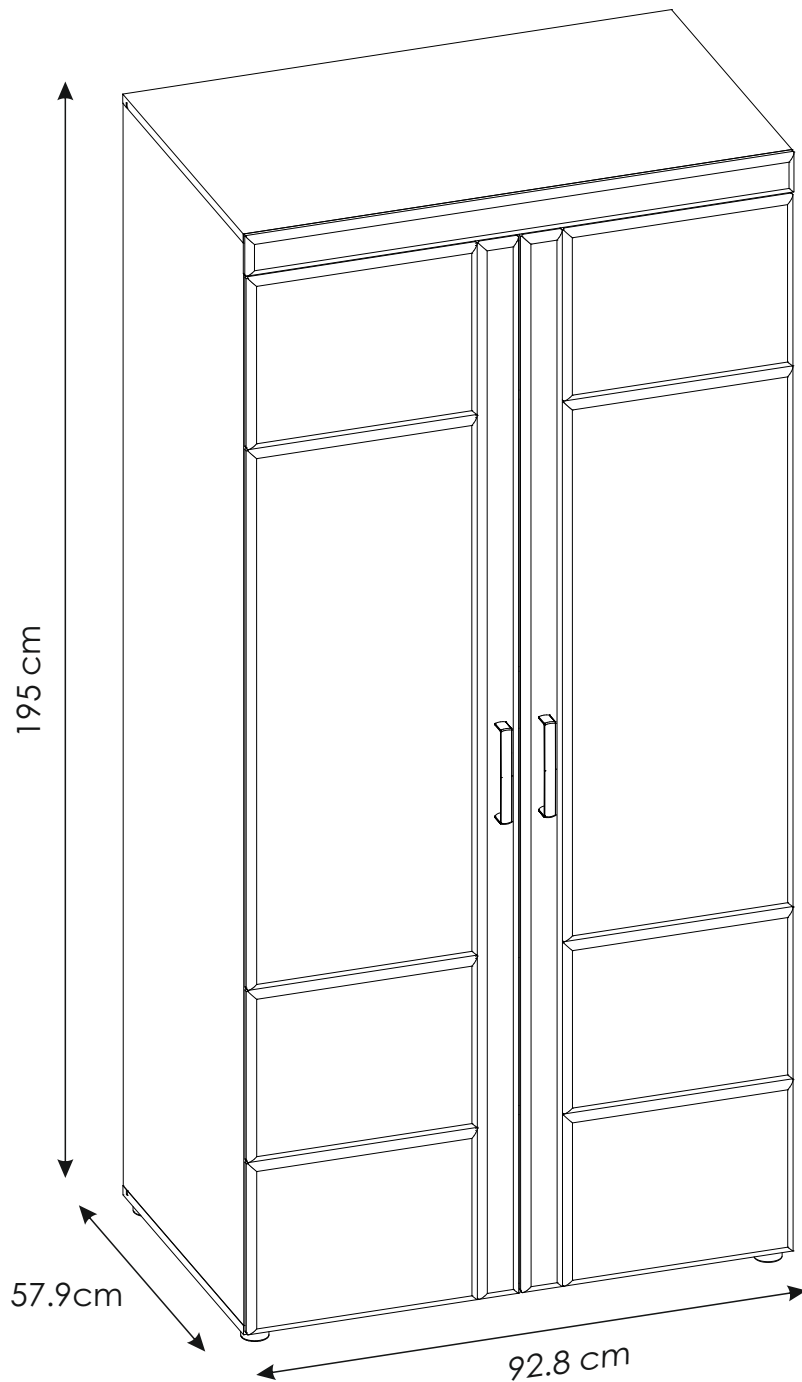
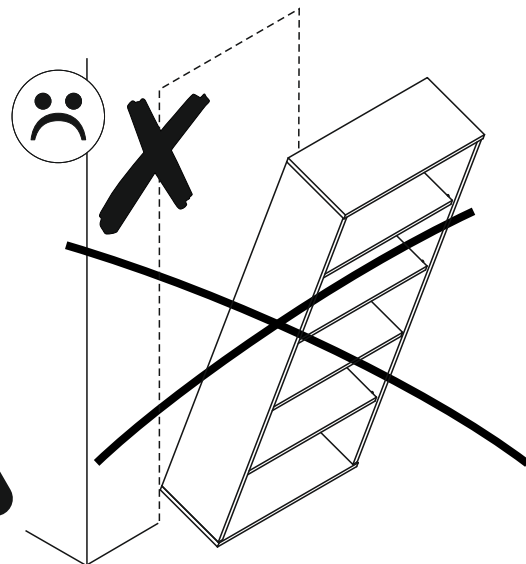

PL.  
**UWAGA!** Mebel należy trwale zamocować do ściany, aby uniknąć ryzyka związanego z przewróceniem się mebla. W paczce znajdują się elementy mocujące odpowiednie wyłącznie do ścian betonowych lub z pełnej cegły. Jeśli Twoja ściana wykonana jest z innego materiału lub nie masz pewności co do budowy tej ściany, skonsultuj się w kwestii montażu ze specjalistą.

RU.  
**ПРИМЕЧАНИЕ!** Эту мебель необходимо всегда прикреплять к стене, чтобы избежать рисков, связанных с переворотом мебели. В пакете находятся крепежные элементы, которые подходят исключительно к бетонным стенам или из целого кирпича. Если стена изготовлена из другого материала или Вы не уверены относительно строения стены, проконсультируйтесь относительно монтажа со специалистом.

I.  
**ATTENZIONE!** Il mobile deve essere permanentemente fissato alla parete per evitare i rischi derivanti da un ribaltamento del mobile. La confezione contiene solo elementi di fissaggio adatti per pareti in calcestruzzo o in latrezo pieno. Se la vostra parete è realizzata in materiale diverso o avete dubbi sulla costruzione della parete, consultare uno specialista per un montaggio corretto.

SLO.  
**POZOR!** Pohištvo trajno pritrdite na steno, da preprečite tveganje, da se prevrne. V paketu so pritrilni elementi, ki so ustrezni izključno za betonske stene in za stene iz polne opeke. Če je vaša stena izdelana iz drugih materialov ali niste gotovi glede konstrukcije stene, se o montaži posvetujte s strokovnjakom.

EN.  
**WARNING!** To prevent this furniture from tripping over, fix it to the wall permanently. The package includes fastening elements only suitable for concrete or full-brick walls. If your wall is made of a different material or you are unsure as to the construction of the wall, please consult a specialist regarding installation.

FR.  
**ATTENTION!** Ce meuble doit être fixé en permanence au mur pour éviter les risques de chute. L'ensemble comprend des moyens de fixation adaptés uniquement aux murs de béton ou de brique. Si votre mur est fait d'un matériau différent ou si vous êtes incertain quant à la construction du mur, consultez un spécialiste.

HR.  
**NAPOMENA!** Namještaj mora biti trajno pričvršćen za zid, kako bi se izbjegao rizik od njegova prevrtanja. U paketu se nalaze elementi za pričvršćivanje prikladni isključivo za betonske zidove ili punu ciglu. Ako je Vaš zid izrađen od drugog materijala ili niste sigurni od čega je napravljen Vaš zid, konzultirajte se sa stručnjakom u vezi sa montažom.

CZ.  
**POZOR!** Nábytek je nutné pevně připevnit ke zdi, abychom se vyhnuli riziku spojenému s jeho převrnutím. V balíčku se nacházejí připevňující prvky vhodné výhradně do betonových zdí nebo zdí z plných cihel. Pokud jsou Vaše zdi zhotoveny z jiného materiálu nebo si nejste jejich konstrukcí jisti, konzultujte otázku montáže se specialistou.

CN.  
**注意!** 本家具需要固定在墙上以免倒塌。  
 本包所含有的固定部件仅适用于混凝土墙及整砖墙。  
 欲使用在其他墙体或不确定墙体时，  
 请向专家询问安装方式。

D.  
**ACHTUNG!** Um alle mit dem Umkippen des Möbels verbundenen Risiken auszuschließen, muss das Möbel fest an der Wand verankert werden. Die im Paket enthaltenen Beschläge für die Wandbefestigung sind ausschließlich für Wände aus Beton oder Vollziegeln geeignet. Sollten die heimischen Wände aus anderem Baumaterial bestehen oder sollte es Zweifel in Hinsicht auf dieses Baumaterial geben, bitte eine Fachkraft zu Rate ziehen.

HU.  
**FIGYELEM!** Rögzítse a bútorokat a falhoz, hogy elkerülje a bútor felborulásának kockázatát. A készletben kizárólag beton- vagy téglafalhoz használható kötőelemek találhatók. Ha a fal más anyagból készült, vagy ha nem tudja, milyen falak találhatók otthonában, forduljon szakemberhez.



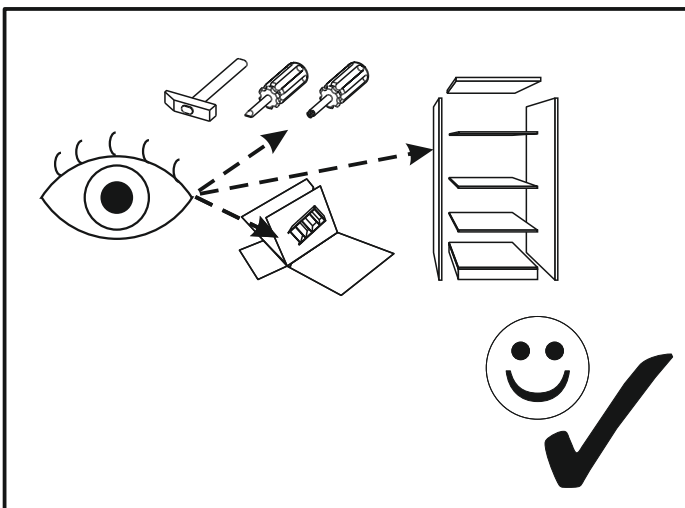
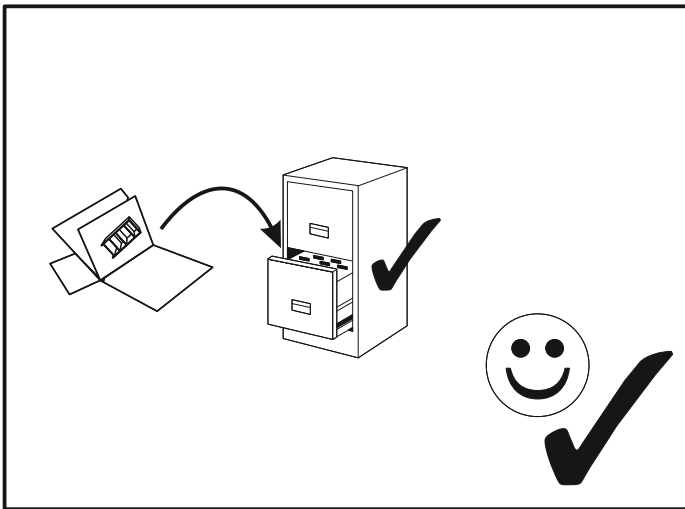
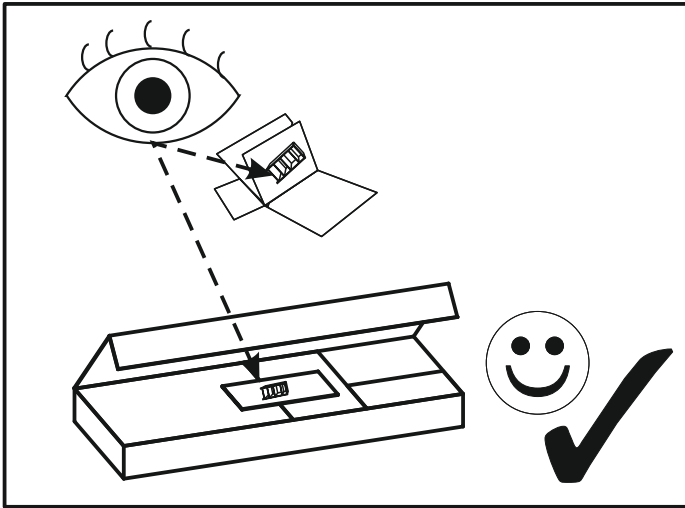

SK.  
**POZOR!** Nábytok musí byť trvalo pripevnený k stene tak, aby sa zamedzilo riziku prevrátenia. V balíku sa nachádzajú upevňovacie komponenty výlučne pre betónové steny alebo steny z plnej tehly. Ak je Vaša stena z iného materiálu alebo ak si nie ste istí, z čoho je stena vyhotovená, vyžiadajte si odbornú pomoc.

E.  
**¡ATENCIÓN!** El mueble debe ser fijado permanentemente a la pared para evitar el riesgo relacionado con el vuelco del mueble. En el paquete hay elementos de fijación adecuados solo para paredes de hormigón o de ladrillo entero. Si su pared está hecha de otro material o no está seguro sobre la construcción de esta pared, consulte el montaje con un especialista.

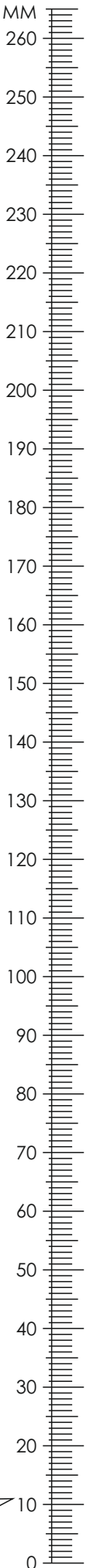

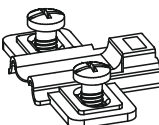
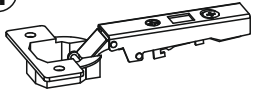
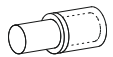
# CNAS02

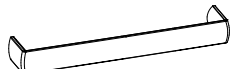
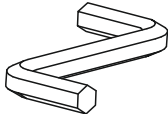
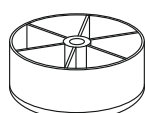
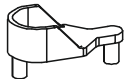
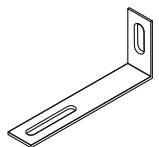
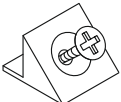
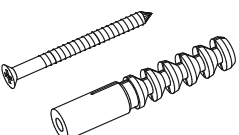
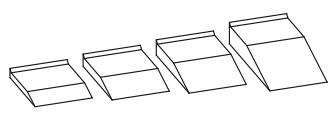

<b>A1</b>	8 x 35 mm	x22	<b>BC22</b>		x8	<b>BC21</b>		x8
<b>C1</b>	4 x 13 mm	x16	<b>D2</b>		x4	<b>E0</b>		x14
<b>E1</b>	15 x 12 mm	x14	<b>F1</b>	6 x 34 mm	14	<b>GO</b>		x4
<b>G1</b>	7 x 50 mm	x4	<b>H1</b>		x2	<b>I1</b>	3,5 x 16 mm	x2
<b>I2</b>	4 x 16 mm	x2	<b>I5</b>	3,5 x 27 mm	x5	<b>J4</b>	4 x 25mm	x80
<b>K4</b>	M4 x 25mm	x4	<b>M</b>		x1	<b>N1</b>	3 X 16 mm	x10
<b>O15</b>		x5	<b>P4</b>		x2	<b>Q9</b>		x2
<b>R4</b>		x14	<b>S13</b>		x2	<b>Z</b>		x1
<b>Z1</b>	L-886	x1						

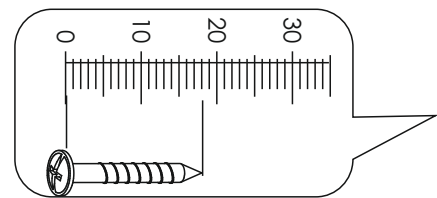

# CNAS02

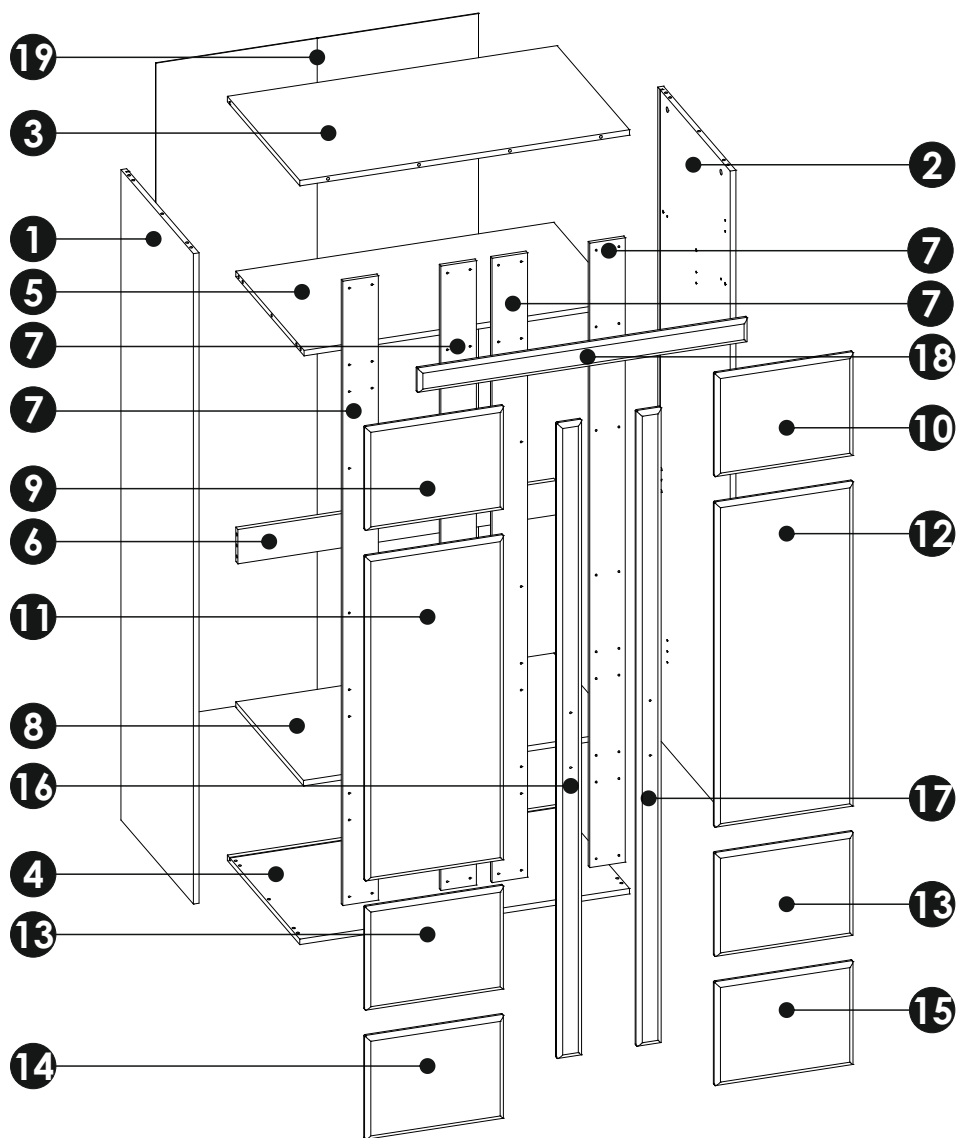
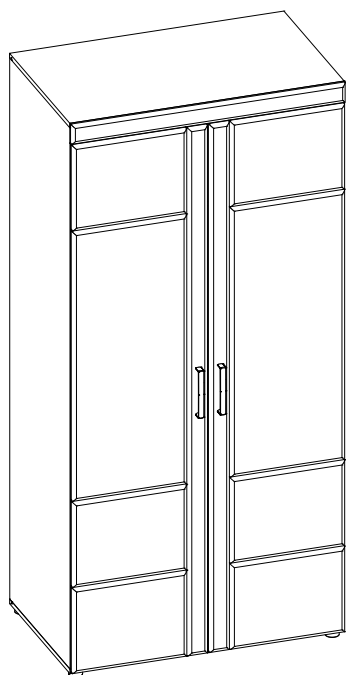

<b>1</b>	1898	560	16	x1	3/3
<b>2</b>	1898	560	16	x1	2/3
<b>3</b>	928	560	16	x1	3/3
<b>4</b>	928	560	16	x1	3/3
<b>5</b>	895	528	16	x1	2/3
<b>6</b>	895	100	16	x1	3/3
<b>7</b>	1818	100	12	x4	2/3

<b>8</b>	895	523	16	x1	2/3
<b>9</b>	390	302	19	x1	1/3
<b>10</b>	390	302	19	x1	1/3
<b>11</b>	390	948	19	x1	1/3
<b>12</b>	390	948	19	x1	1/3
<b>13</b>	390	302	19	x2	1/3

<b>14</b>	390	302	19	x1	1/3
<b>15</b>	390	302	19	x1	1/3
<b>16</b>	1854	70	19	x1	3/3
<b>17</b>	1854	70	19	x1	3/3
<b>18</b>	928	71	19	x1	3/3
<b>19</b>	1912	908	3	x1	2/3

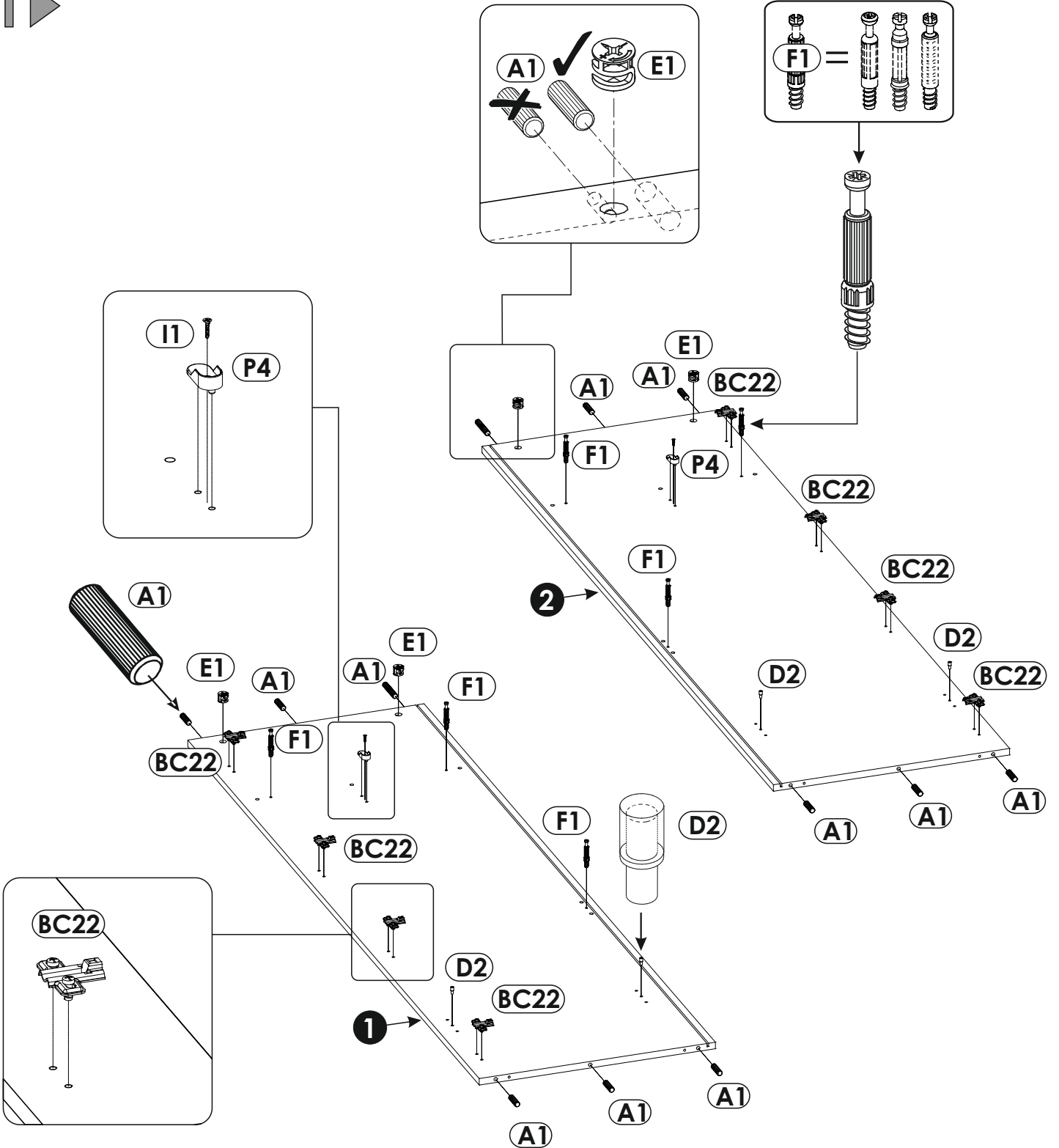
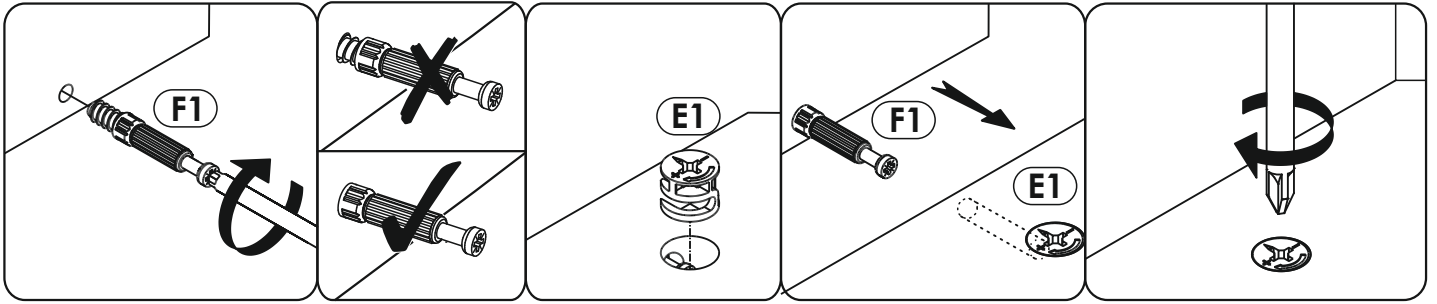

2 ▶

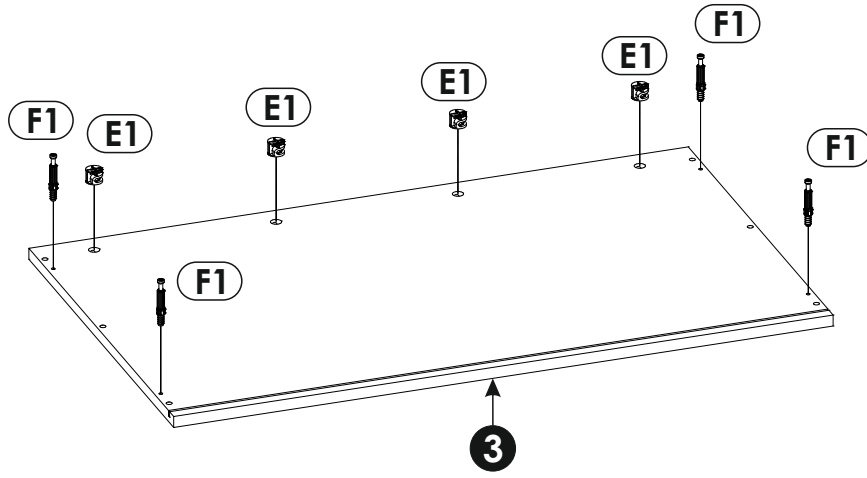

3 ▶

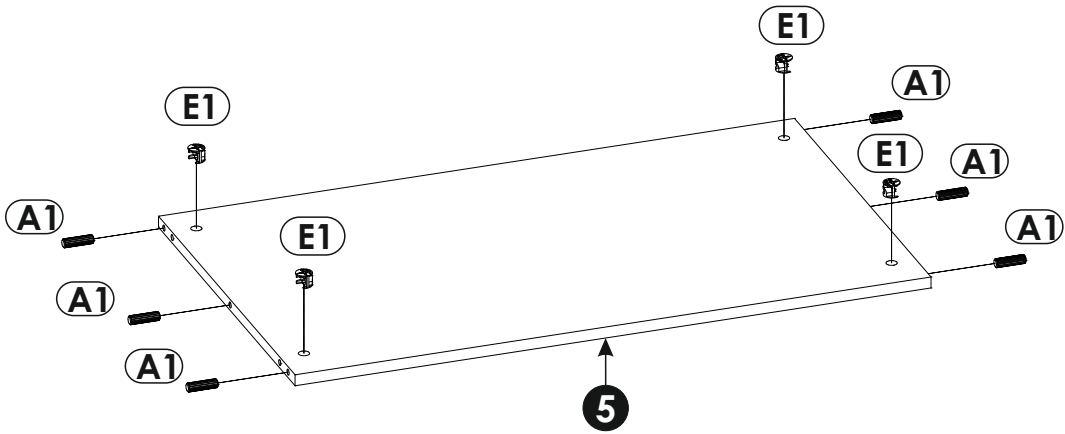

4 ▶

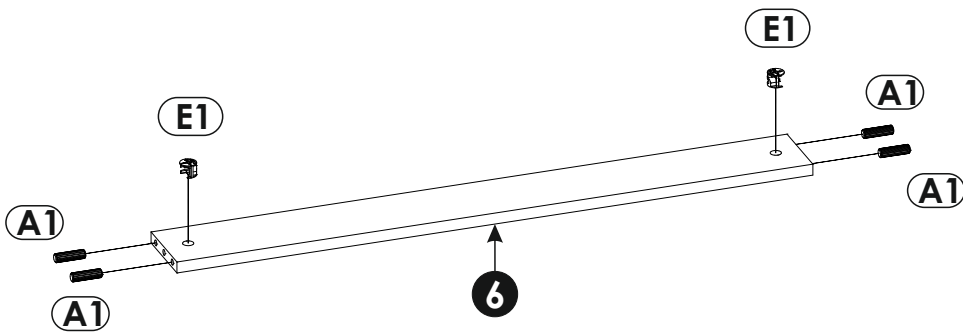

5 ▶

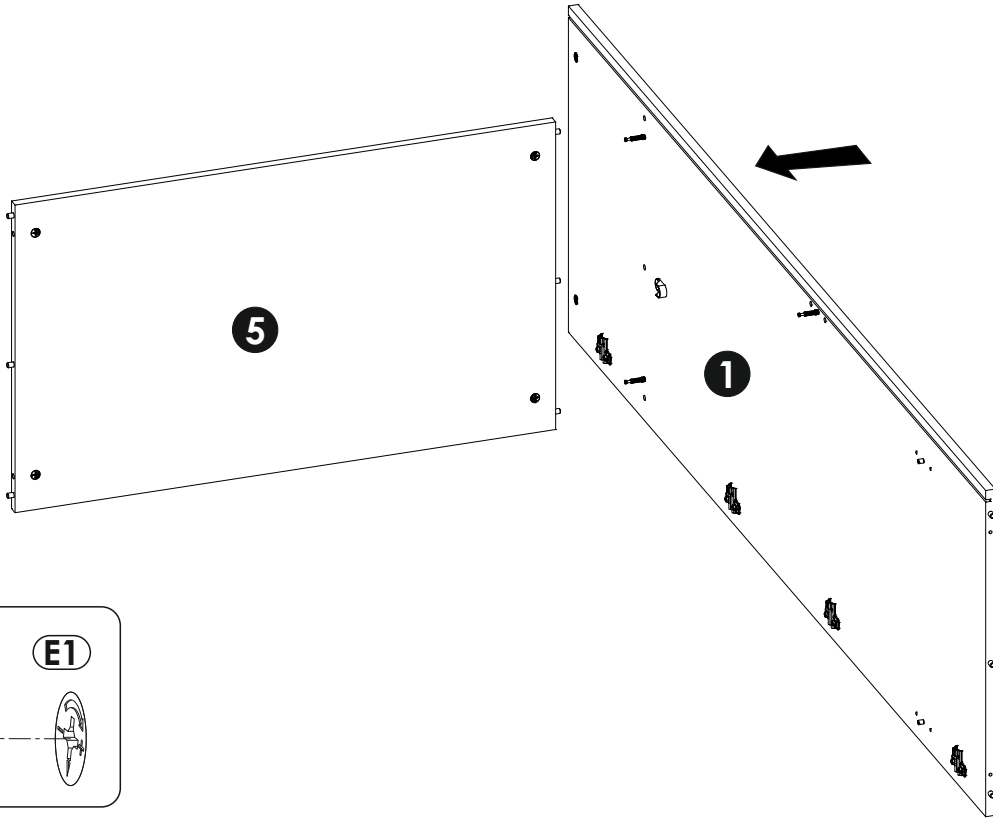

6 ▶

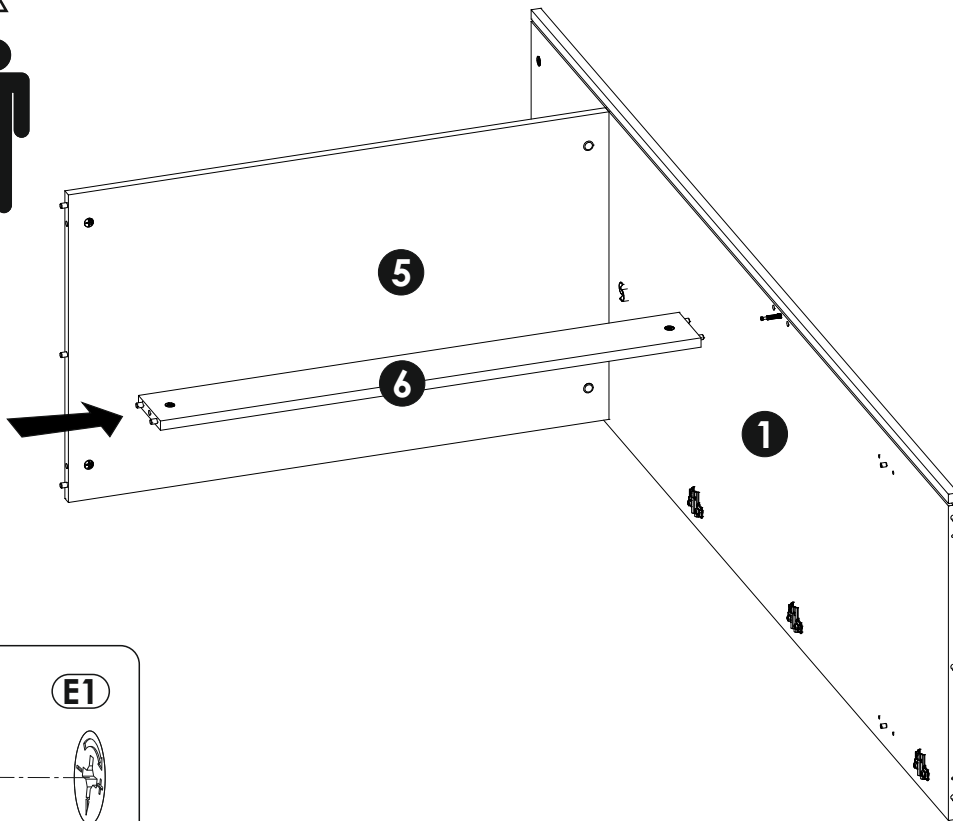
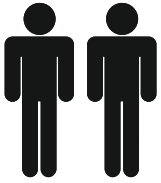



7 ▶

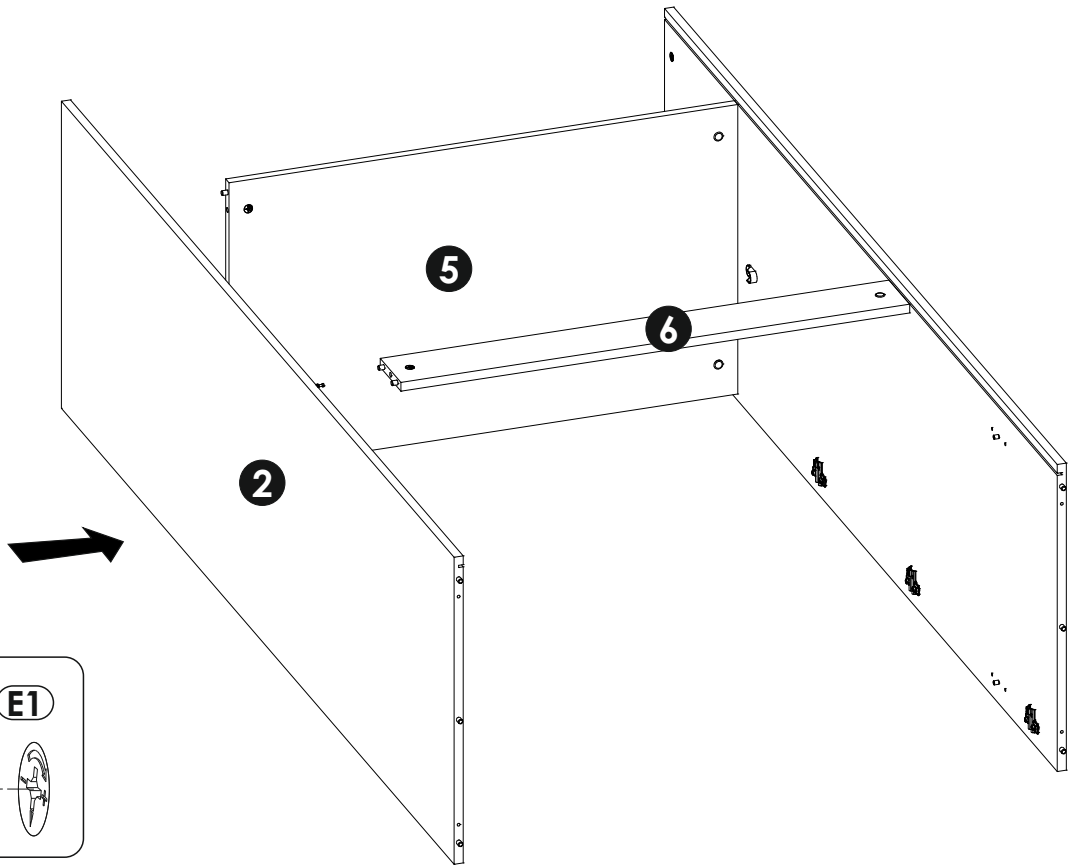
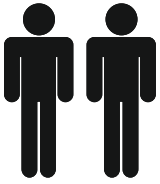

8 ▶

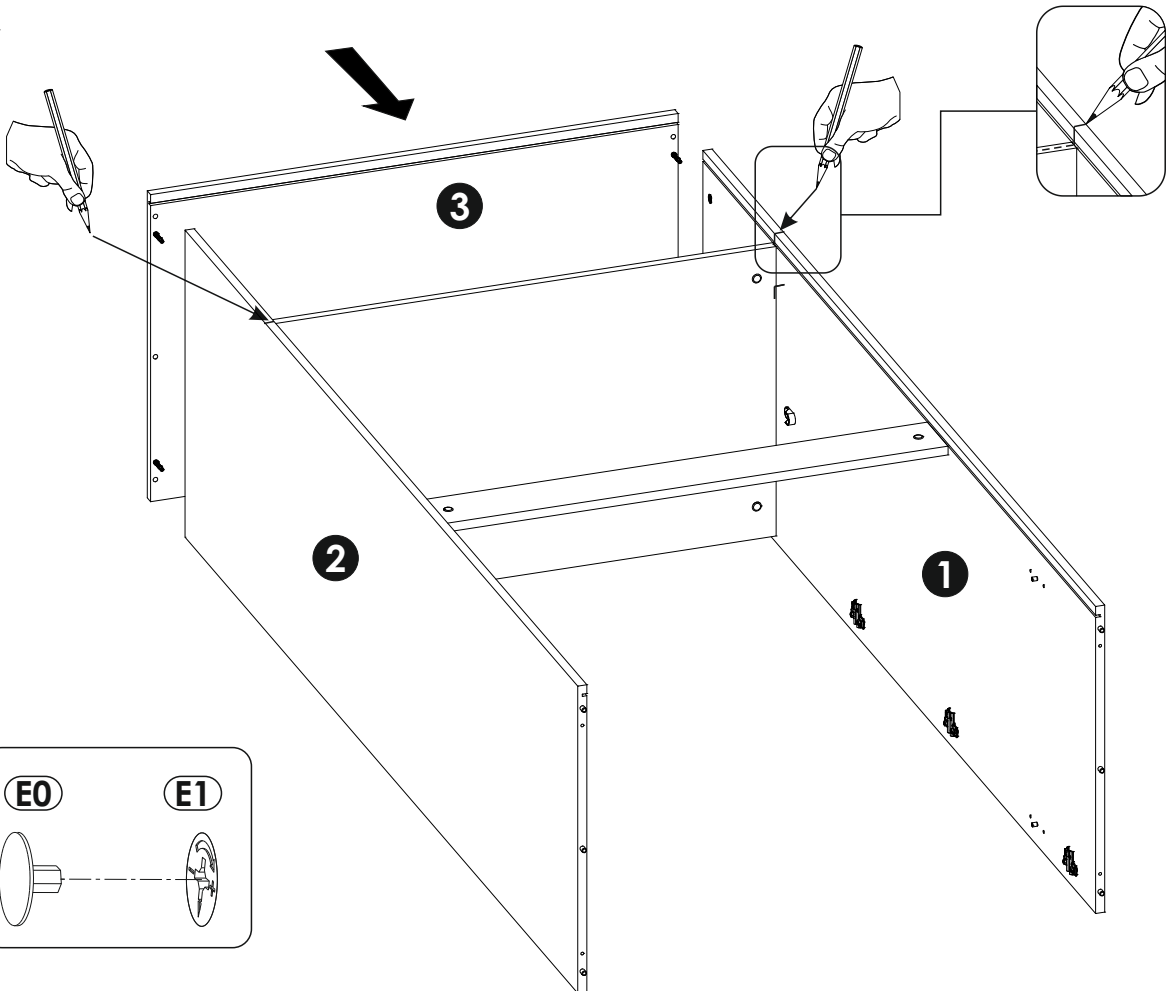

9 ▶

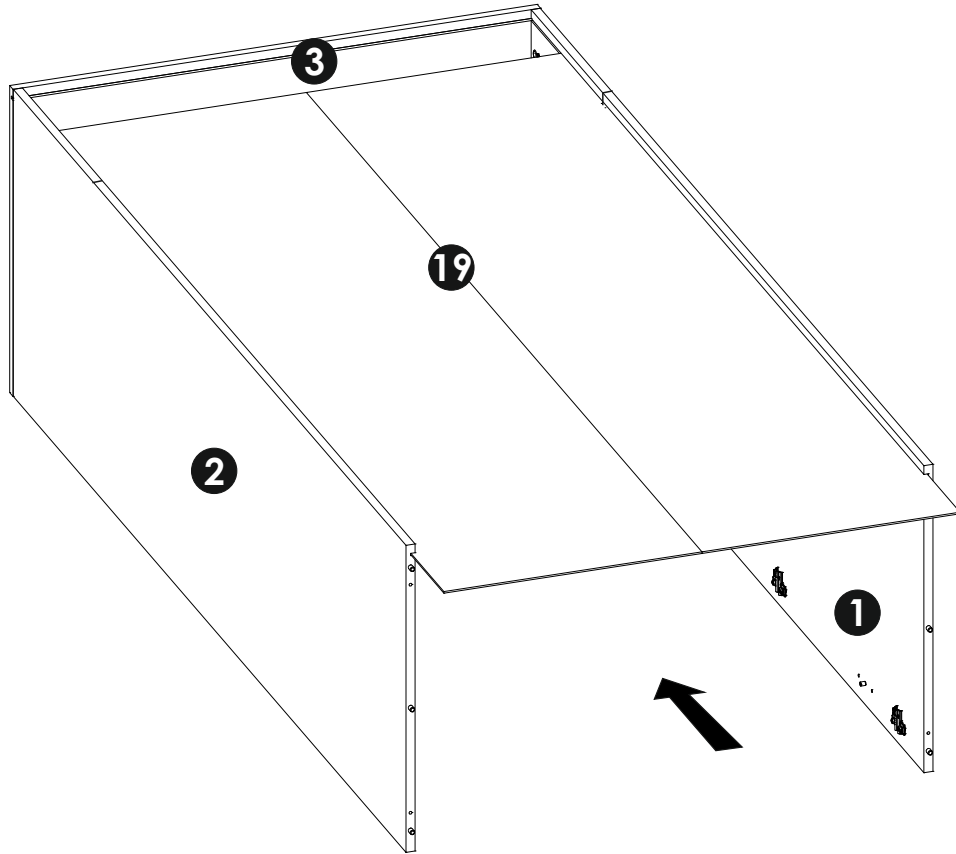

10 ▶

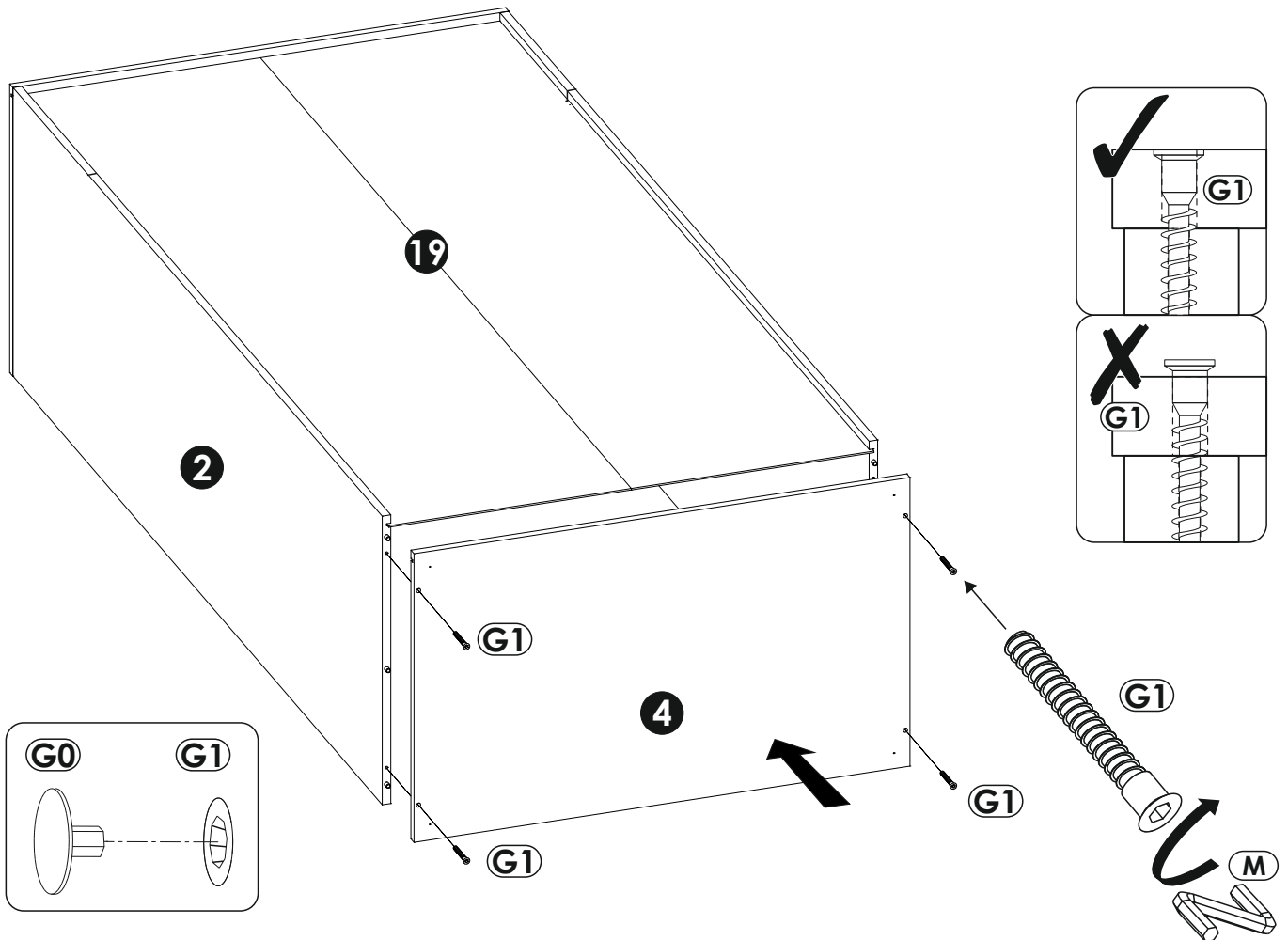

11▶

**A=B**

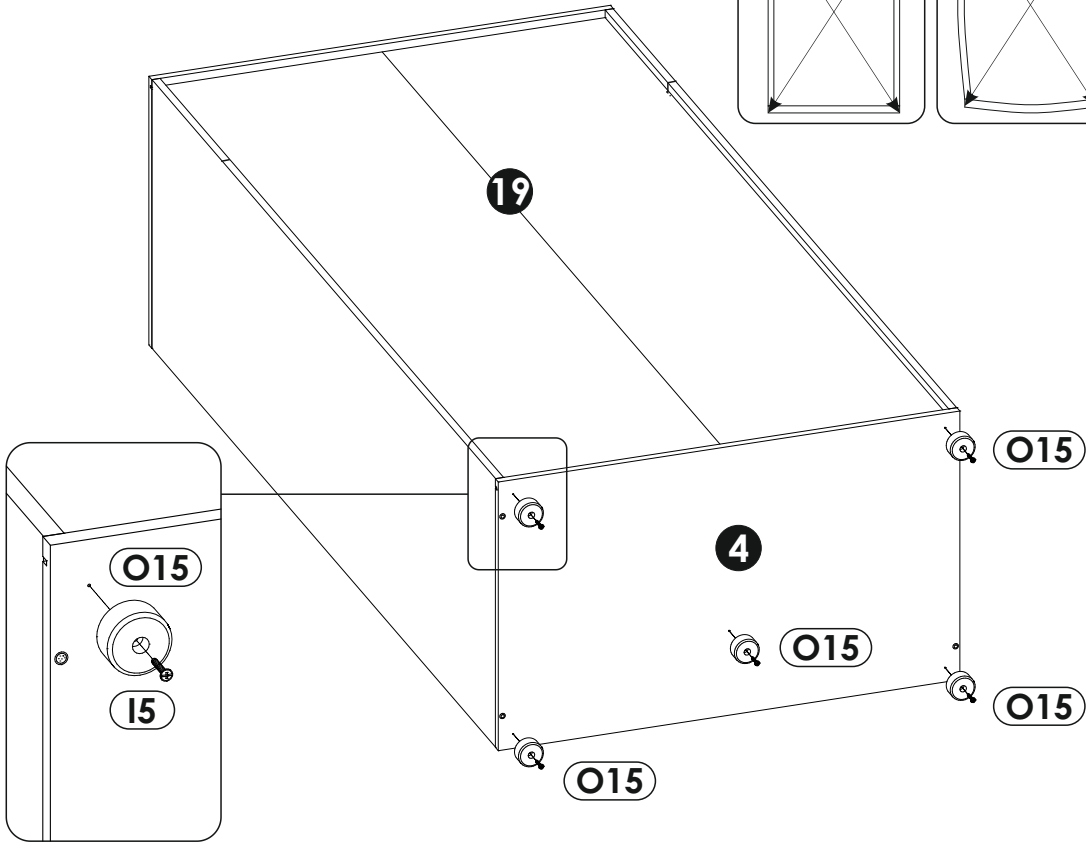
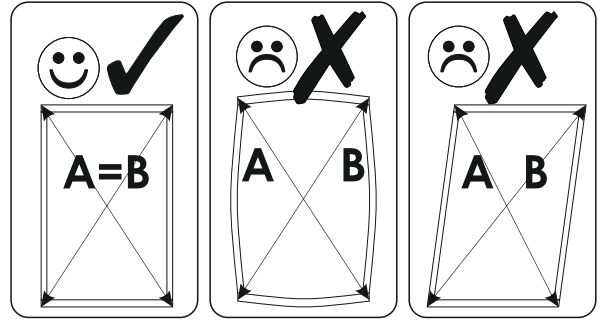

12▶

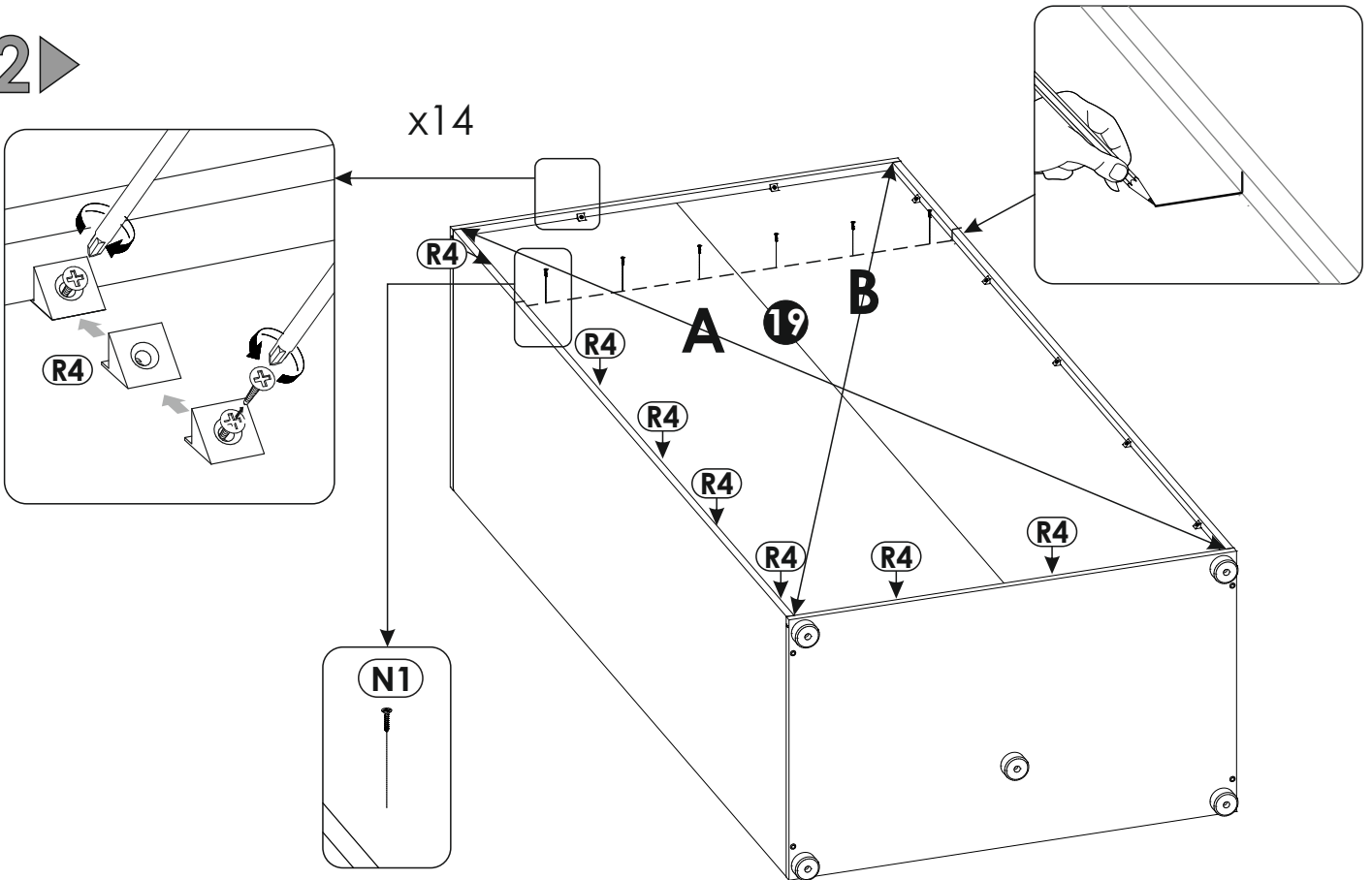

13▶

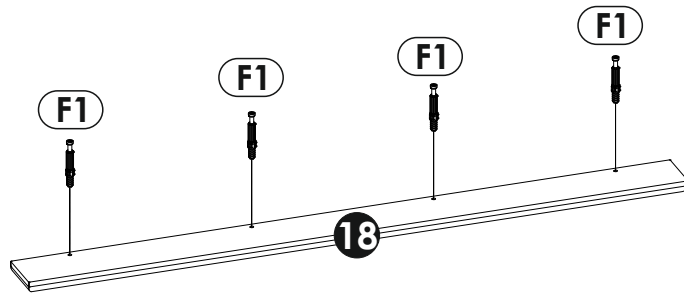

14▶

