

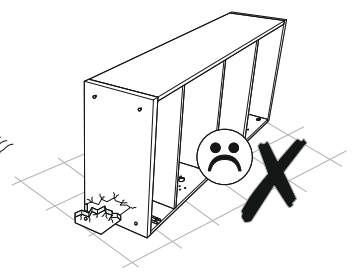

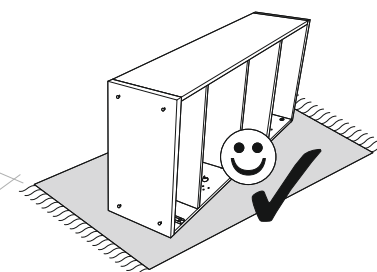

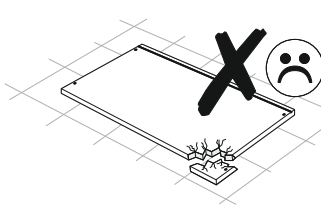

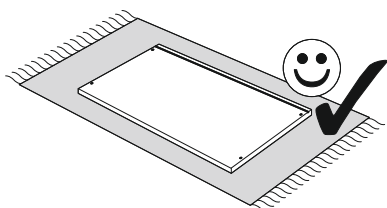

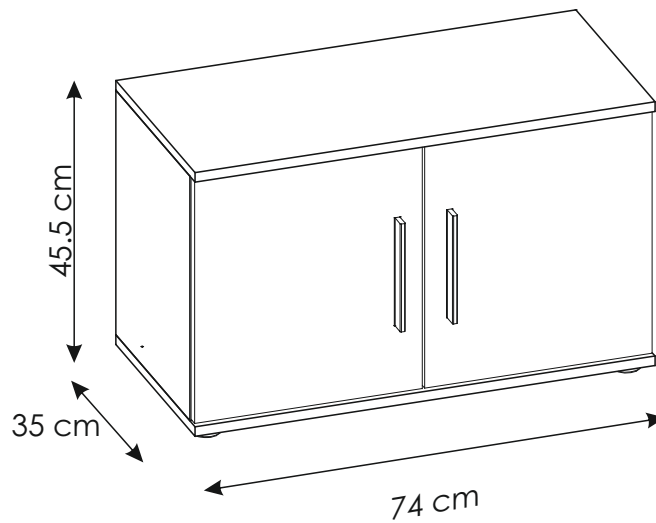
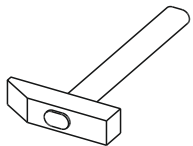
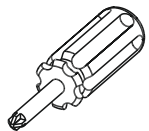
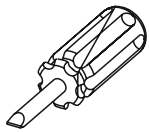
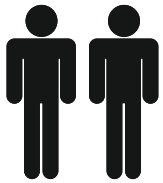
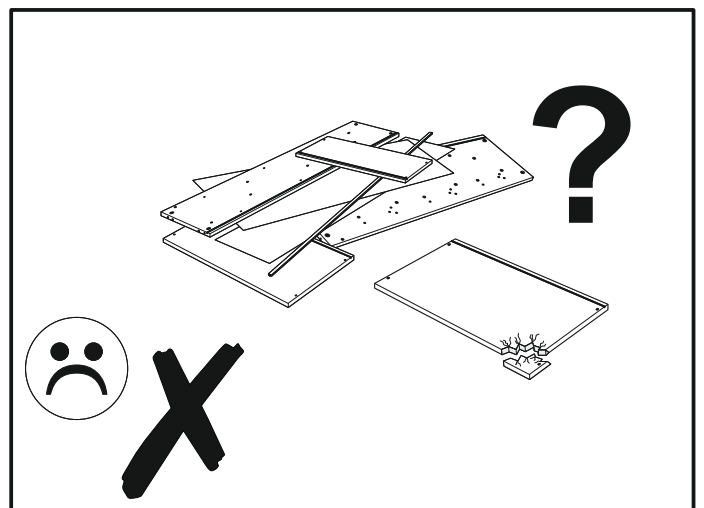
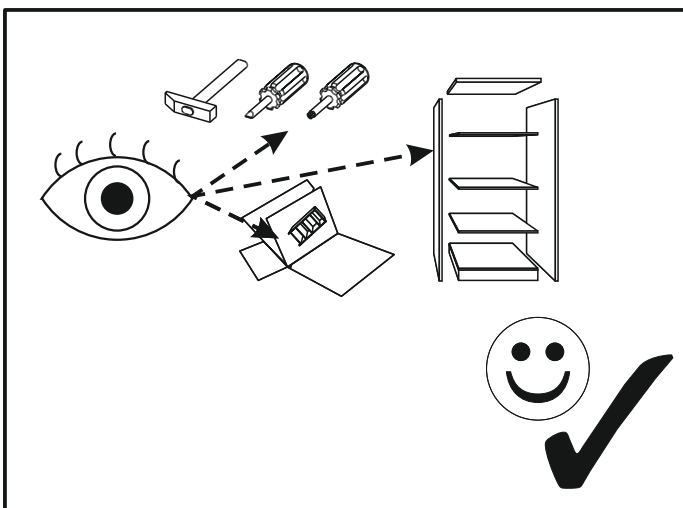
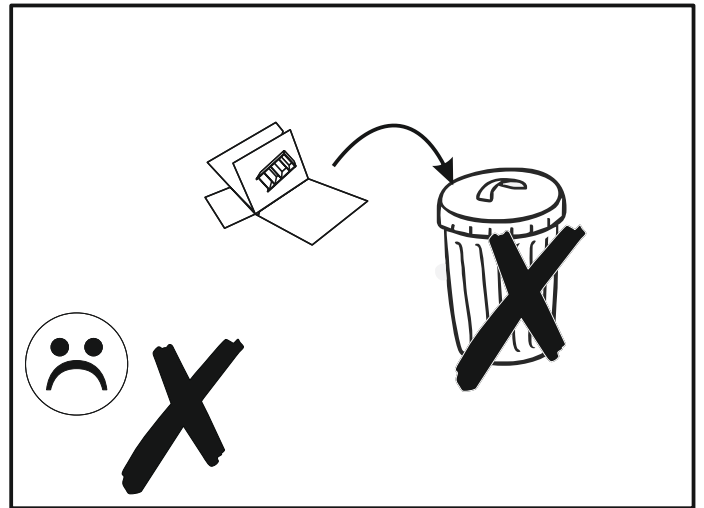
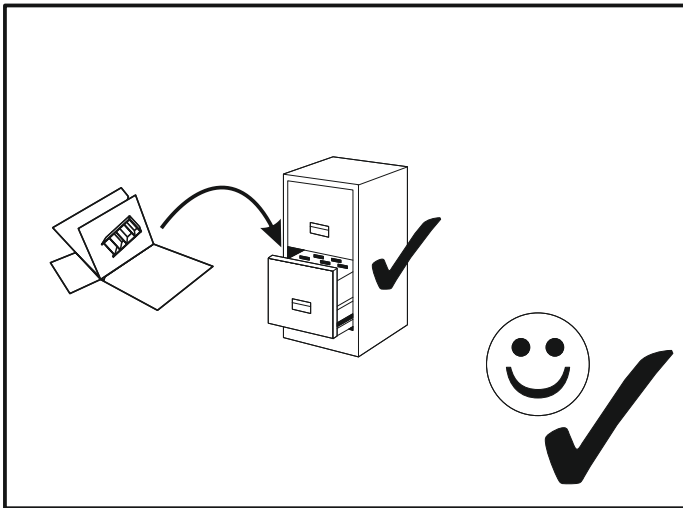
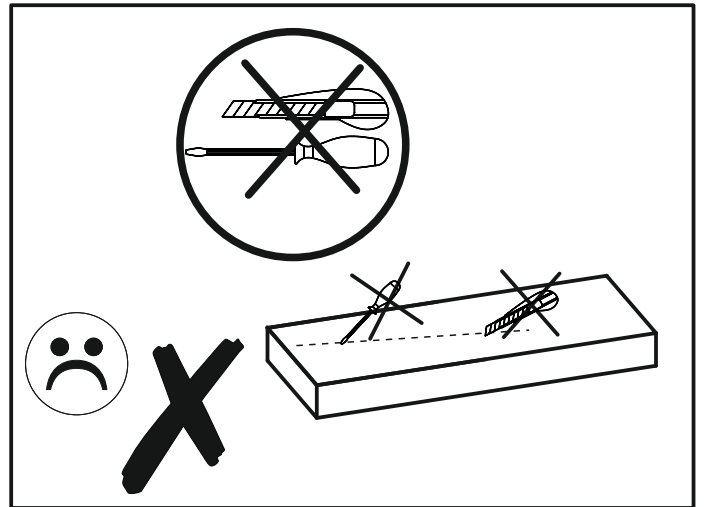
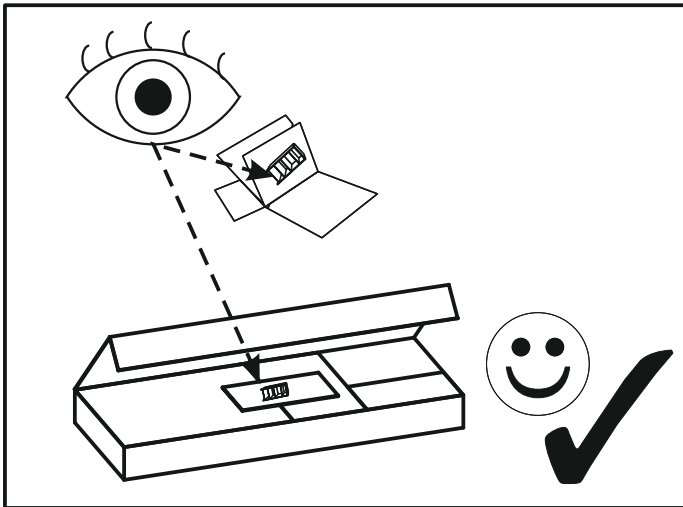

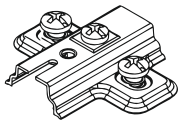
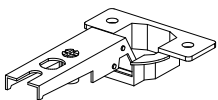
GEMINI - KOMODA 2D

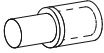

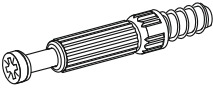

GEMINI - KOMODA 2D

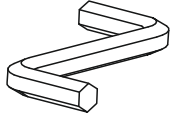
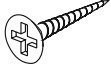
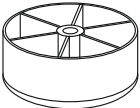
A1 8 x 35 mm x12 	B0 x4 	B1 x4 
C2 5 x 13 mm x8 	D2 x8 	E0 x12 
E1 15 x 12 mm x12 	F1 6 x 34 mm x12 	H1 x2 
I10 3,0 x 20 mm x5 	I11 3,5 x 27 mm x4 	M x1 
N1 3 X 16 mm x18 	O1 x5 	

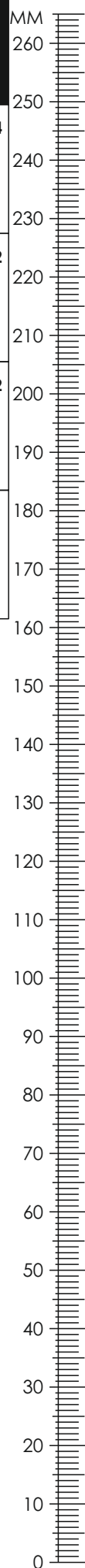

GEMINI - KOMODA 2D

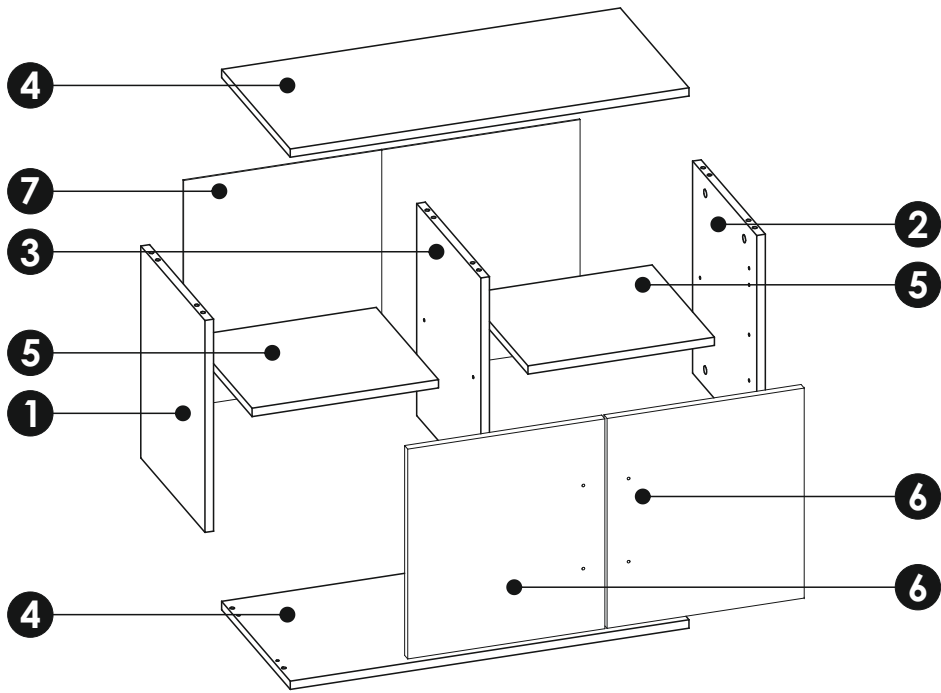
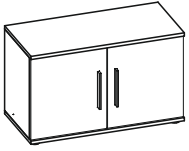

1	408	327	16 x1	1/1
2	408	327	16 x1	1/1
3	408	327	16 x1	1/1
4	740	350	16 x2	1/1
5	346	317	16 x2	1/1
6	404	366	16 x2	1/1
7	736	430	3 x1	1/1

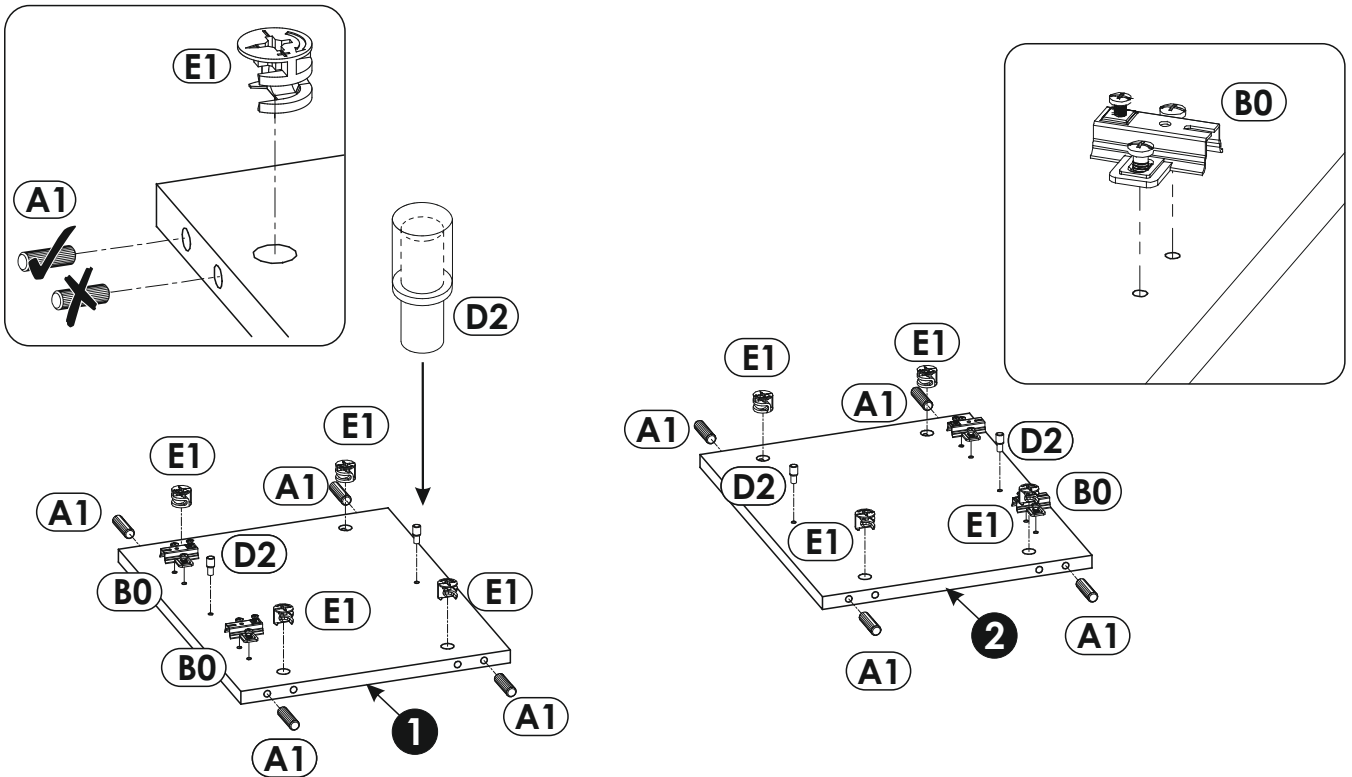
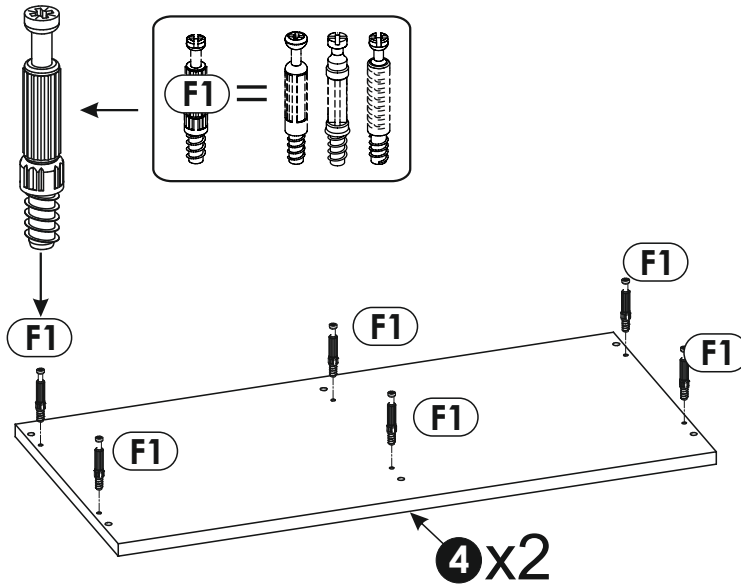
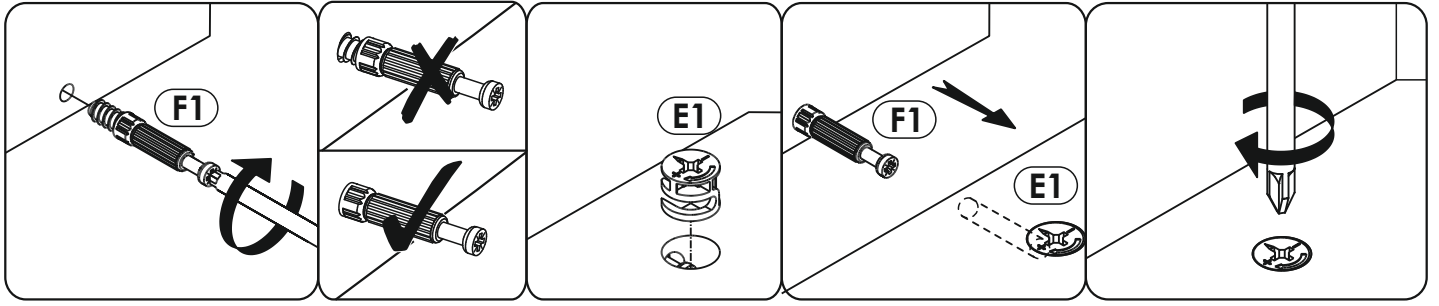

2▶

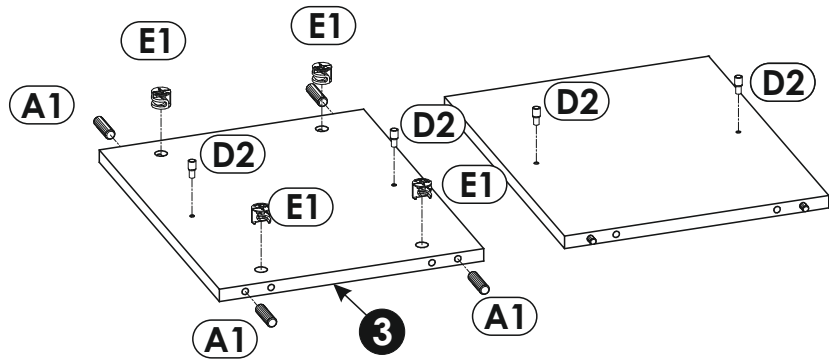

3▶

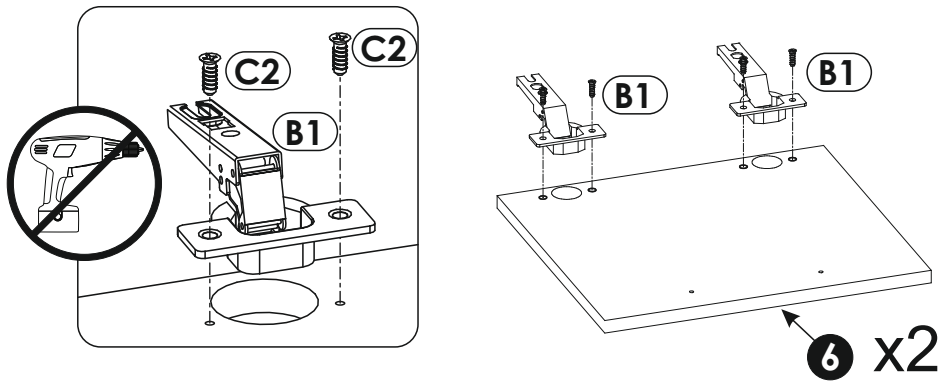

4▶

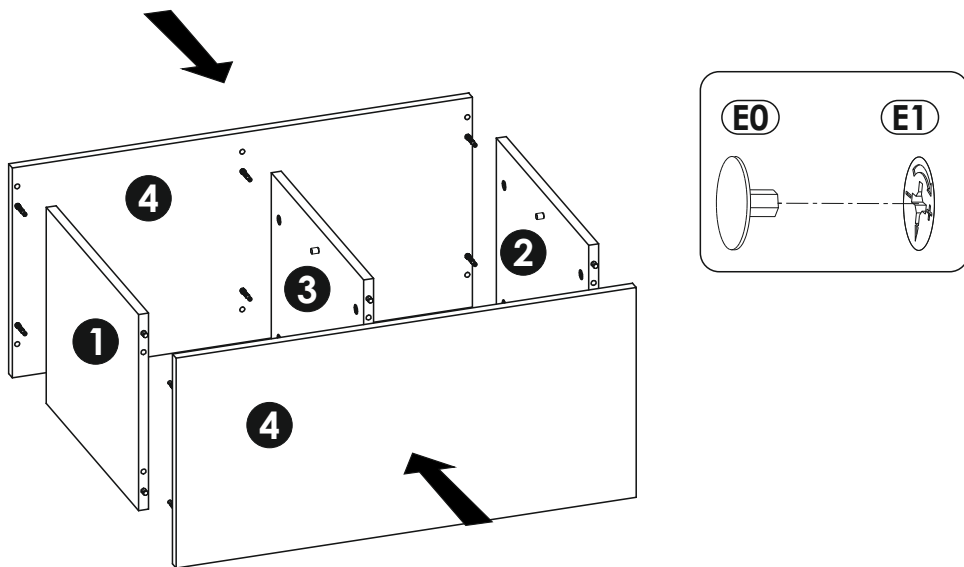

5 ▶

A=B

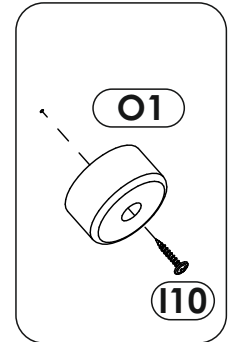
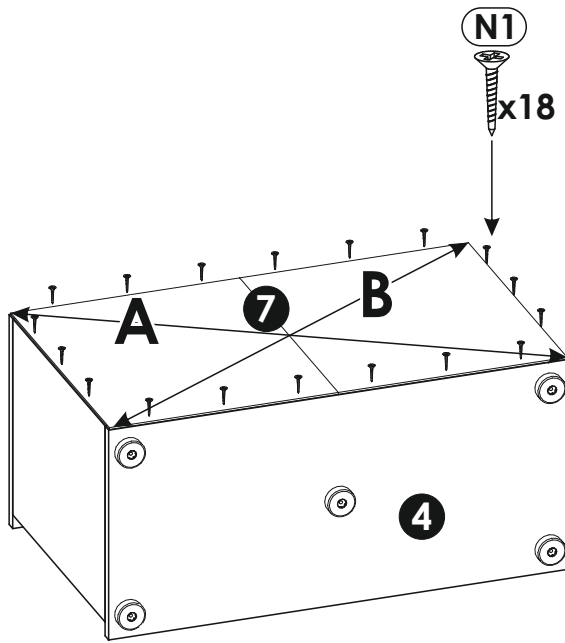
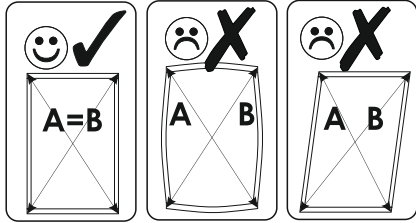

6 ▶

